



DRS. SOEGLIO  
TJOKRODIHARJO DIP  
PERUM, IKIP 15-KETIP  
SURABAYA

# CONCISE INORGANIC CHEMISTRY

FOURTH EDITION

— J.D. Lee —

Senior Lecturer in Inorganic Chemistry  
Loughborough University of Technology

*S. M. M. M.*  
*glasgow, Nov. 1991*



CHAPMAN & HALL

University and Professional Division

London · New York · Tokyo · Melbourne · Madras

UK	Chapman & Hall, 2-6 Boundary Row, London SE1 8HN
USA	Chapman & Hall, 29 West 35th Street, New York NY 10001
JAPAN	Chapman & Hall Japan, Thomson Publishing Japan, Hirakawacho Nemoto Building, 7F, 1-7-11 Hirakawa-cho, Chiyoda-ku, Tokyo 102
AUSTRALIA	Chapman & Hall Australia, Thomas Nelson Australia, 102 Dodds Street, South Melbourne, Victoria 3205
INDIA	Chapman & Hall India, R. Seshadri, 32 Second Main Road, CIT East, Madras 600 035

First published 1964.

Fourth edition 1991

© 1964, 1965, 1977, 1991 J.D. Lee

Typeset in 10/12 Times by Best-set Typesetter Ltd.

Printed in Singapore by Fong & Sons Printers Pte. Ltd.

ISBN 0 412 40290 4

Apart from any fair dealing for the purposes of research or private study, or criticism or review, as permitted under the UK Copyright Designs and Patents Act, 1988, this publication may not be reproduced, stored, or transmitted, in any form or by any means, without the prior permission in writing of the publishers, or in the case of reprographic reproduction only in accordance with the terms of the licences issued by the Copyright Licensing Agency in the UK, or in accordance with the terms of licences issued by the appropriate Reproduction Rights Organization outside the UK. Enquiries concerning reproduction outside the terms stated here should be sent to the publishers at the UK address printed on this page.

The publisher makes no representation, express or implied, with regard to the accuracy of the information contained in this book and cannot accept any legal responsibility or liability for any errors or omissions that may be made.

**British Library Cataloguing in Publication Data**

Lee, J.D. (John David) 1931-

Concise inorganic chemistry. - 4th ed.

I. Inorganic chemistry

I. Title

546

ISBN 0-412-40290-4

**Library of Congress Cataloging-in-Publication Data**

Lee, J.D. (John David), 1931-

Concise inorganic chemistry / J.D. Lee. - 4th ed.

p. cm.

Rev. ed. of: A new concise inorganic chemistry, 3rd ed. 1977.

Includes bibliographical references and index.

ISBN 0-412-40290-4 (pbk.)

I. Chemistry, Physical and theoretical. 2. Chemical bonds.

I. Lee, J.D. (John David), 1931- New concise inorganic chemistry.

II. Title.

QD453.2.L45 1991

546—dc20

91-9816

CIP

# Contents

Preface to the fourth edition	xxx
SI units	xxxiv
Nomenclature in the period table	xxxv
<b>PART ONE THEORETICAL CONCEPTS AND HYDROGEN</b>	<b>1</b>
<b>Chapter 1 <u>Atomic structure and the periodic table</u></b>	<b>3</b>
The atom as a nucleus with orbital electrons	3
Atomic spectra of hydrogen and the Bohr theory	4
Refinements to the Bohr theory	8
The dual nature of electrons – particles or waves	10
The Heisenberg uncertainty principle	11
The Schrödinger wave equation	12
Radial and angular functions	15
Pauli exclusion principle	21
Build-up of the elements, Hund's rule	21
Sequence of energy levels	24
<u>Arrangement of the elements in groups in the periodic table</u>	25 ✓
Further reading	27
Problems	27
<b>Chapter 2 Introduction to bonding</b>	<b>30</b>
Attainment of a stable configuration	30
Types of bonds	30
Transitions between the main types of bonding	32
Ionic bonds	32
Covalent bonds	33
Oxidation numbers	34
Coordinate bonds	34
Double and triple bonds	35
Metallic bonds and metallic structures	36
Melting points	39
Conductivity	40
Solubility	40
Speed of reactions	40 ✓

Chapter 3 The ionic bond	43
Structures of ionic solids	43
Radius ratio rules	43
Calculation of some limiting radius ratio values	44
Coordination number 3 (planar triangle)	44
Coordination number 4 (tetrahedral)	44
Coordination number 6 (octahedral)	45
Close packing	46
Classification of ionic structures	47
Ionic compounds of the type AX (ZnS, NaCl, CsCl)	47
Structures of zinc sulphide	47
Sodium chloride structure	47
Caesium chloride structure	48
Ionic compounds of the type AX <sub>2</sub> (CaF <sub>2</sub> , TiO <sub>2</sub> , SiO <sub>2</sub> )	48
Calcium fluoride (fluorite) structure	48
Rutile structure	48
β-cristobalite (silica) structure	49
Layer structures (CdI <sub>2</sub> , CdCl <sub>2</sub> , [NiAs])	49
Cadmium iodide structure	49
Cadmium chloride structure	51
Nickel arsenide structure	51
Structures containing polyatomic ions	51
A more critical look at radius ratios	52
A cautionary word on radius ratios	52
Lattice energy ✓	54
Features of solids	58
Stoichiometric defects	59
Schottky defects	59
Frenkel defects	59
Nonstoichiometric defects	61
Metal excess	61
F-centres	61
Interstitial ions and electrons	62
Metal deficiency	62
Positive ions absent	63
Extra interstitial negative ions	63
Semiconductors and transistors	63
Rectifiers	65
Photovoltaic cell	66
Transistors	66
Micro-minaturized semiconductor devices – integrated circuits	68
Further reading	68
Problems	69

Chapter 4 The covalent bond	72
Introduction	72
1 The Lewis theory	72
The octet rule	72
Exceptions to the octet rule	73
2 Sidgwick-Powell theory	74
3 Valence shell electron pair repulsion (VSEPR) theory	74 ✓
Effect of lone pairs	75
Effect of electronegativity	76
Isoelectronic principle	77
Some examples using the VSEPR theory	77
BF <sub>3</sub> and the [BF <sub>4</sub> ] <sup>-</sup> ion	77
Ammonia NH <sub>3</sub>	77
Water H <sub>2</sub> O	77
Phosphorus pentachloride PCl <sub>5</sub>	78
Chlorine trifluoride ClF <sub>3</sub>	78
Sulphur tetrafluoride SF <sub>4</sub>	79
The triiodide ion I <sub>3</sub> <sup>-</sup>	79
Sulphur hexafluoride SF <sub>6</sub>	80
Iodine heptafluoride IF <sub>7</sub>	80
4 Valence bond theory	80 ✓
Hybridization	81
The extent of <i>d</i> orbital participation in molecular bonding	85
→ Sigma and pi bonds	87
Molecular orbital method	89
LCAO method	90 ✓
<i>s-s</i> combinations of orbitals	90
<i>s-p</i> combinations of orbitals	93
<i>p-p</i> combinations of orbitals	94
<i>p-d</i> combinations of orbitals	96
<i>d-d</i> combinations of orbitals	96
Non-bonding combinations of orbitals	96
Rules for linear combination of atomic orbitals	97
Examples of molecular orbital treatment for homonuclear diatomic molecules	98
H <sub>2</sub> <sup>+</sup> molecule ion	99
H <sub>2</sub> molecule	99
He <sub>2</sub> <sup>+</sup> molecule ion	99
He <sub>2</sub> molecule	99
Li <sub>2</sub> molecule	100
Be <sub>2</sub> molecule	100
B <sub>2</sub> molecule	101
C <sub>2</sub> molecule	102
N <sub>2</sub> molecule	104
O <sub>2</sub> molecule	105
O <sub>2</sub> <sup>-</sup> ion	105

$O_2^-$ ion	107
$F_2$ molecule	107
Examples of molecular orbital treatment for heteronuclear diatomic molecules	107
NO molecule	109
CO molecule	110
HCl molecule	112
Examples of molecular orbital treatment involving delocalized $\pi$ bonding	112
Carbonate ion $CO_3^{2-}$	112
Nitrate ion $NO_3^-$	114
Sulphur trioxide $SO_3$	114
Ozone $O_3$	115
Nitrite ion $NO_2^-$	116
Carbon dioxide $CO_2$	116
Azide ion $N_3^-$	117
Summary of multi-centre $\pi$ bonded structures	117
United atom method	118
Further reading	119
Problems	120
<b>Chapter 5 The metallic bond</b>	<b>121</b>
General properties of metals	121
Conductivity	121
Lustre	122
Malleability and cohesive force	122
Crystal structures of metals	126
Bond lengths	127
Theories of bonding in metals	127
Free electron theory	128
Valence bond theory	128
Molecular orbital or band theory	128
Conductors, insulators and semiconductors	131
Alloys	132
Ionic compounds	132
Interstitial alloys and related compounds	132
Substitutional alloys	135
Superconductivity	140
Further reading	144
Problems	145
<b>Chapter 6 General properties of the elements</b>	<b>146</b>
Size of atoms and ions	146
Size of atoms	146
Size of ions	146
Problems with ionic radii	148
Trends in ionic radii	148

Ionization energies	149
Electron affinity	153
Born–Haber cycle	154
Polarizing power and polarizability – Fajans' rules	156
Electronegativity	157
Pauling	158
Mulliken	161
Allred and Rochow	162
Metallic character	163
Variable valency and oxidation states	164
Standard electrode potentials and electrochemical series	165
Oxidation–reduction reactions	170
The use of reduction potentials	172
The occurrence and isolation of the elements	178
Mechanical separation of elements that exist in the native form	178
Thermal decomposition methods	179
Displacement of one element by another	180
High temperature chemical reduction methods	181
Reduction by carbon	181
Reduction by another metal	182
Self-reduction	182
Reduction of oxides with hydrogen	182
Electrolytic reduction	182
In aqueous solution	183
In other solvents	183
In fused melts	183
Factors influencing the choice of extraction process	183
Thermodynamics of reduction processes	183
Horizontal, vertical and diagonal relationships in the periodic table	189
Further reading	190
Problems	191
<b>Chapter 7 Coordination compounds</b>	<b>194</b>
Double salts and coordination compounds	194
Werner's work	195
More recent methods of studying complexes	198
Effective atomic numbers	200
Shapes of <i>d</i> orbitals	201
Bonding of transition metal complexes	202
Valence bond theory	202
Crystal field theory	202
Molecular orbital theory	202
Valence bond theory	203 ✓
Crystal field theory	204 ✓
Octahedral complexes	205
Effects of crystal field splitting	210

Tetragonal distortion of octahedral complexes (Jahn–Teller distortion)	214
Square planar arrangements	217
Tetrahedral complexes	219
— $\triangleright$ Chelates	222
Magnetism	225
Extension of the crystal field theory to allow for some covalency	226
Molecular orbital theory	~227
$\pi$ acceptors	229
$\pi$ donors	229
Nomenclature of coordination compounds	✓230
Isomerism	232
Polymerization isomerism	232
Ionization isomerism	232
Hydrate isomerism	233
Linkage isomerism	233
Coordination isomerism	233
Coordination position isomerism	234
Geometric isomerism or stereoisomerism	234
Optical isomerism	234
Further reading	236
Problems	236
<b>Chapter 8 Hydrogen and the hydrides</b>	<b>240</b>
Electronic structure	240
Position in the periodic table	240
Abundance of hydrogen	241
Preparation of hydrogen	241
Properties of molecular hydrogen	243
Isotopes of hydrogen	245
<i>Ortho</i> and <i>para</i> hydrogen	248
Hydrides	248
Ionic or salt-like hydrides	249
Covalent hydrides	250
Metallic (or interstitial) hydrides	252
Intermediate hydrides	254
The hydrogen ion	254
Hydrogen bonding	255
— $\swarrow$ Acids and bases	256
Arrhenius theory	258
Acids and bases in proton solvents	260
Bronsted–Lowry theory	262
Lewis theory	265
The solvent system	265
The Lux–Flood definition	267
The Usanovich definition	267
Hard and soft acids and bases	267



Further reading	268
Problems	271
<b>PART TWO THE s-BLOCK ELEMENTS</b>	<b>273</b>
<b>Chapter 9 Group I – the alkali metals</b>	<b>275</b>
Introduction	275
Occurrence and abundance	275
Extraction of the metals	277
Uses of Group I metals and their compounds	278
Electronic structure	280
Size of atoms and ions	280
Density	280
Ionization energy	281
Electronegativity and bond type	281
Born–Haber cycle: energy changes in the formation of ionic compounds	282
Structures of the metals, hardness, and cohesive energy	285
Melting and boiling points	286
Flame colours and spectra	286
Colour of compounds	287
Chemical properties	288
Reaction with water	288
Reaction with air	289
Reaction with nitrogen	289
Oxides, hydroxides, peroxides and superoxides	290
Reaction with air	290
Normal oxides – monoxides	290
Hydroxides	290
Peroxides and superoxides	291
Sulphides	293
Sodium hydroxide	294
Sodium hydrogencarbonate (sodium bicarbonate)	294
Sodium sulphate	294
Oxosalts – carbonates, bicarbonates, nitrates and nitrites	295
Halides and polyhalides	296
Hydrides	297
Solubility and hydration	298
Solutions of metals in liquid ammonia	302
Compounds with carbon	303
Organic and organometallic compounds	303
Complexes, crowns and crypts	305
Biological importance	308
Differences between lithium and the other Group I elements	309
Further reading	311
Problems	312

<b>Chapter 10 The chlor-alkali industry</b>	<b>315</b>
Leblanc process	315
Weldon and Deacon processes	317
Electrolytic processes	317
Diaphragm cell	318
Mercury cathode cell	319
Quantities	321
Sodium carbonate	321
The Solvay (or ammonia-soda) process	323
Further reading	324
Problems	324
<b>Chapter 11 Group II – the alkaline earth elements</b>	<b>325</b>
Introduction	325
Electronic structure	325
Occurrence and abundance	325
Extraction of the metals	327
Dow sea water process	329
Dow natural brine process	329
Size of atoms and ions	329
Ionization energy	330
Electronegativity	331
Hydration energies	331
Anomalous behaviour of beryllium	332
Solubility and lattice energy	334
Solutions of the metals in liquid ammonia	335
Chemical properties	335
Reaction with water	335
Hydroxides	336
Hardness of water	337
Reaction with acids and bases	338
Oxides and peroxides	338
Sulphates	341
Nitrates	342
Hydrides	342
Halides	344
Nitrides	345
Carbides	346
Insoluble salts	347
Organometallic compounds	347
Complexes	349
Biological role of $Mg^{2+}$ and $Ca^{2+}$	353
Differences between beryllium and the other Group II elements	353
Further reading	354
Problems	354



## Preface to the fourth edition

It is 25 years since the first edition of *Concise Inorganic Chemistry* was published. This is a remarkable life for any textbook, and it seemed appropriate to mark the Silver Jubilee with a new edition. This, the fourth edition, has taken three years to write, and was made possible by the authorities at Loughborough University who granted me a year's study leave, and by my colleagues who shouldered my teaching duties during this time. I am greatly indebted to them. The new edition is inevitably larger than its predecessors, though the publishers were reluctant to change the title to *A Less Concise Inorganic Chemistry!* Einstein said 'all things are relative', and the book is still concise compared with other single volumes and with multi-volume series on the subject.

The aim of the fourth edition remains exactly the same as that for the first edition of the book. That is to provide a modern textbook of inorganic chemistry that is long enough to cover the essentials, yet short enough to be interesting. It provides a simple and logical framework into which the reader should be able to fit factual knowledge, and extrapolate from this to predict unknown facts. The book is intended to fill the gap between school books and final year honours degree chemistry texts. The need for an appropriate and sympathetically written text has increased significantly now that the first cohorts of GCSE students are applying to read chemistry at degree and diploma level. It is aimed primarily at first or second year degree students in chemistry, but will also be useful for those doing chemistry as ancillary subjects at university, and also for BTEC courses and Part I Grad RIC in polytechnics and technical colleges. Some parts will be usable by good sixth form students. Above all it is intended to be easy to read and understand.

The structure of the book is largely unchanged, and is based on descriptive chemistry combined with some of the reasons why elements and compounds behave in the way they do. For convenience the book is divided into six 'parts' covering theoretical concepts and hydrogen, the *s*-block, the *p*-block, the *d*-block, the *f*-block and other topics. Every chapter has been completely rewritten, updated and enlarged. The section on theoretical concepts and hydrogen contains introductory chapters on atomic structure, ionic, covalent and metallic bonding and general pro-

erties, which make up about one fifth of the book. The original chapter on coordination compounds has been moved into this section since it is mainly about the coordinate bond and crystal field theory. These are followed by a systematic coverage of hydrogen, the main group elements, the transition elements, the lanthanides and the actinides in turn. There are separate chapters on the nucleus and spectroscopy. To make it easier to find the appropriate section, the text has been divided into a larger number of chapters. Thus, the original chapter on bonding has been split into an introduction to bonding and chapters on ionic, covalent and metallic bonding. The original chapter on the *s*-block has been split into chapters on Groups I and II. That on the *p*-block has been split into chapters on Groups III, IV, V, VI, VII and 0. The original chapter on the *d*-block has been split into an introduction to the transition elements followed by ten smaller chapters on the triads of elements. I have retained a very large and comprehensive index, and a large table of contents as previously. The descriptive material necessarily has a large place, but the book attempts to show the reasons for the structure, properties and reactions of compounds, wherever this is possible with elementary methods.

At the end of most chapters is a section on further reading, and almost 600 references are given to other work. The references may be used at several different levels. In increasing order of complexity these are:

1. Easy to understand articles in journals such as the *Journal of Chemical Education*, *Chemistry in Britain* and *Education in Chemistry*.
2. References to specialized textbooks.
3. Review articles such as *Quarterly Reviews*, *Coordination Chemistry Reviews*, and the proceedings of specialist conferences and symposia.
4. A small number of references are made to original articles in the primary literature. In general such references are beyond the scope of this text, but those given have special (often historical) significance. Examples include the use of Ellingham diagrams, the Sidgwick-Powell theory of molecular shape, and the discovery of ferrocene and of warm superconductors.

Chemistry is still a practical subject. In the chemical industry, as with many others, the adage 'where there's muck there's money' holds particularly true. Unless chemicals were needed and used in large amounts there would be no chemical industry, hence no students in chemistry, no teachers of chemistry, and no need for textbooks. An American professor told me he divided inorganic chemistry books into two types: *theoretical* and *practical*. In deciding how to classify any particular book he first looked to see if the extraction of the two most produced metals (Fe and Al) was adequately covered, what impurities were likely to be present, and how the processing was adapted to remove them. Second, he looked to see if the treatment of the bonding in xenon compounds and ferrocene was longer than that on the production of ammonia. Third, he looked to see if the production and uses of phosphates were covered adequately. For some years there has been a trend for chemistry teaching to become more

theoretical. There is always theoretical interest in another interesting oxidation state or another unusual complex, but the balance of this book is tilted to ensure that it does not exclude the commonplace, the mundane and the commercially important. This book is intentionally what my American friend would call the 'practical' type.

It is distressing to find both teachers and students who show little idea of which chemicals are commercially important and produced in very large tonnages. What are the products used for? What processes are used now as opposed to processes used 30 or more years ago? Where do the raw materials come from, and in what ways are the processes actually used related to likely impurities in the raw materials? Many books give scant coverage to these details. Though this is not intended to be an industrial chemistry book, it relates to chemistry in the real world, and this edition contains rather more on large tonnage chemicals. I have contacted about 250 firms to find what processes are currently in use. Production figures are quoted to illustrate which chemicals are made in large amounts and where the minerals come from. The figures quoted are mainly from *World Mineral Statistics*, published by the British Geological Survey in 1988, and from the *Industrial Statistics Yearbook 1985* Vol. II, published by the United Nations, 1987, New York. Both are mines of information. Inevitably these figures will vary slightly from year to year, but they illustrate the general scale of use, and the main sources of raw materials. Thus, the production of major chemicals such as  $\text{H}_2\text{SO}_4$ ,  $\text{NH}_3$ ,  $\text{NaOH}$ ,  $\text{Cl}_2$ ,  $\text{O}_2$  and  $\text{N}_2$  are adequately covered. Other important materials such as cement and steel, polymers such as polythene, silicones and Teflon, soap and detergents are also covered. In addition, many smaller scale but fascinating applications are described and explained. These include baking powder, photography, superconductors, transistors, photocopiers, carbon dating, the atomic bomb and uses of radioisotopes.

There is currently a greater awareness of environmental issues. These are discussed in more detail than in previous editions. Problems such as freons and the ozone layer, the greenhouse effect, acid rain, lead pollution, the toxic effects of tin and mercury, asbestos, excessive use of phosphates and nitrates and the toxic effects of various materials in drinking water are discussed. The section on the development of the atomic bomb and the peaceful uses of atomic energy is also enlarged.

While much inorganic chemistry remains the same, it is a living subject and the approach to our current thinking and the direction of future work have altered. In particular our ideas on bonding have changed. Until 1950 inorganic chemistry was largely descriptive. The research and development which led to the production of the atomic bomb in 1946 is probably the greatest chemical achievement of the century. The impetus from this led to the discovery of many new elements in the actinide and lanthanide series. This was followed by a period of great interest in physical inorganic chemistry, where instead of just observing what happened we looked for the reasons why. Thermodynamics and kinetics were applied to chemical reactions, and magnetism and UV-visible spectroscopy were explored.

There was a flurry of activity when it was found that the noble gases really did form compounds. This was followed by a concentrated phase of preparing organometallic compounds and attempting to explain the bonding in these compounds, many of which defied rational explanation by existing theories. Future developments seem likely to fall in two main areas – bioinorganic chemistry and new materials. Much bioinorganic work is in progress: how enzymes and catalysts function; how haemoglobin and chlorophyll really work; and how bacteria incorporate atmospheric nitrogen so easily when we find it so difficult. Work on new materials includes the production of polymers, alloys, superconductors and semiconductors.

This book is mainly about the chemistry of the elements, which is properly regarded as *inorganic* chemistry. I consider it unhelpful for students to put information into rigid compartments, since the ideas in one subject may well relate to other subjects and the boundaries between subjects are partly artificial. The book incorporates information on the chemistry of the elements regardless of the source of that chemistry. Thus, in places the book crosses boundaries into analytical chemistry, biochemistry, materials science, nuclear chemistry, organic chemistry, physics and polymer chemistry. It is worth remembering that in 1987 the Nobel Prize for Chemistry was given for work on complexes using crowns and crypts which have biological overtones, and the Nobel Prize for Physics was for discoveries in the field of warm superconductors. Both involve chemistry.

I am extremely grateful to Dr A.G. Briggs for help and constructive criticism in the early stages of writing the book. In addition I am greatly indebted to Dr A.G. Fogg for his help and encouragement in correcting and improving the manuscript, and to Professor F. Wilkinson for valuable advice. In a book of this size and complexity it is inevitable that an occasional mistake remains. These are mine alone, and where they are shown to be errors they will be corrected in future editions. I hope that the new edition will provide some interest and understanding of the subject for future generations of students, and that having passed their examinations they may find it useful in their subsequent careers. The final paragraph from the Preface to the First Edition is printed unchanged:

A large amount of chemistry is quite easy, but some is enormously difficult. I can find no better way to conclude than that by the late Professor Silvanus P. Thompson in his book *Calculus Made Easy*, 'I beg to present my fellow fools with the parts that are not hard. Master these thoroughly, and the rest will follow. What one fool can do, another can'.

J.D. Lee  
Loughborough, 1991

## SI UNITS

SI units for energy are used throughout the fourth edition, thus making a comparison of thermodynamic properties easier. Ionization energies are quoted in  $\text{kJ mol}^{-1}$ , rather than ionization potentials in eV. Older data from other sources use eV and may be converted into SI units ( $1 \text{ kcal} = 4.184 \text{ kJ}$ , and  $1 \text{ eV} = 23.06 \times 4.184 \text{ kJ mol}^{-1}$ ).

Metres are strictly the SI units for distance, and bondlengths are sometimes quoted in nanometres ( $1 \text{ nm} = 10^{-9} \text{ m}$ ). However ångström units Å ( $10^{-10} \text{ m}$ ) are a permitted unit of length, and are widely used by crystallographers because they give a convenient range of numbers for bondlengths. Most bonds are between 1 and 2 Å (0.1 to 0.2 nm). Ångström units are used throughout for bondlengths.

The positions of absorption peaks in spectra are quoted in wave numbers  $\text{cm}^{-1}$ , because instruments are calibrated in these units. It must be remembered that these are not SI units, and should be multiplied by 100 to give SI units of  $\text{m}^{-1}$ , or multiplied by 11.96 to give  $\text{J mol}^{-1}$ .

The SI units of density are  $\text{kg m}^{-3}$ , making the density of water  $1000 \text{ kg m}^{-3}$ . This convention is not widely accepted, so the older units of  $\text{g cm}^{-3}$  are retained so water has a density of  $1 \text{ g cm}^{-3}$ .

In the section on magnetism both SI units and Debye units are given, and the relation between the two is explained. For inorganic chemists who simply want to find the number of unpaired electron spins in a transition metal ion then Debye units are much more convenient.



NOMENCLATURE IN THE PERIODIC TABLE

For a long time chemists have arranged the elements in groups within the periodic table in order to relate the electronic structures of the elements to their properties, and to simplify learning. There is however no uniform and universally accepted method of naming the groups. A number of well known books, including Cotton and Wilkinson and Greenwood and Earnshaw, name the main groups and the transition elements as A and B subgroups. Though generally accepted in North America until 1984 and fairly widely accepted up till the present time in most of the world, the use of A and B subgroups dates back to the older Mendeleef periodic table of half a century ago. Its disadvantages are that it may over emphasize slight similarities between the A and B subgroups, and there are a large number of elements in Group VIII. IUPAC have suggested that the main groups and the transition metals should be numbered from 1 to 18. The IUPAC system has gained some acceptance in the USA, but has encountered strong opposition elsewhere, particularly in Europe. It seems inconsistent that the groups of elements in the *s*-block, *p*-block and *d*-block are numbered, but the elements in the *f*-block are not. As in earlier editions of this book, these arguments are avoided, and the main group elements, that is the *s*-block and the *p*-block, are numbered as groups I to VII and 0, depending on the number of electrons in the outer shell of the atoms, and the transition elements are dealt with as triads of elements and named as the top element in each group of three.

Names of the various groups

I	II											III	IV	V	VI	VII	0
IA	IIA	IIIA	IVA	VA	VIA	VIIA	(<--- VIII --->)			IB	IIB	IIIB	IVB	VB	VIB	VII B	0
H	Be											B	C	N	O	F	He
Li	Mg											Al	Si	P	S	Cl	Ne
Na	Ca	Sc	Ti	V	Cr	Mn	Fe	Co	Ni	Cu	Zn	Ga	Ge	As	Se	Br	Ar
K	Sr	Y	Zr	Nb	Mo	Tc	Ru	Rh	Pd	Ag	Cd	In	Sn	Sb	Te	I	Kr
Rb	Ba	La	Hf	Ta	W	Re	Os	Ir	Pt	Au	Hg	Tl	Pb	Bi	Po	At	Xe
Cs																	Rn
1	2	3	4	5	6	7	8	9	10	11	12	13	14	15	16	17	18



**Theoretical Concepts  
and Hydrogen**

**Part  
One**



# Atomic structure and the periodic table

# 1

## THE ATOM AS A NUCLEUS WITH ORBITAL ELECTRONS

All atoms consist of a central nucleus surrounded by one or more orbital electrons. The nucleus always contains protons and all nuclei heavier than hydrogen contain neutrons too. The protons and neutrons together make up most of the mass of the atom. Both protons and neutrons are particles of unit mass, but a proton has one positive charge and a neutron is electrically neutral (i.e. carries no charge). Thus the nucleus is always positively charged. The number of positive charges on the nucleus is exactly balanced by an equal number of orbital electrons, each of which carries one negative charge. Electrons are relatively light – about 1/1836 the mass of a proton. The 103 or so elements at present known are all built up from these three fundamental particles in a simple way.

Hydrogen is the first and most simple element. It consists of a nucleus containing one proton and therefore has one positive charge, which is balanced by one negatively charged orbital electron. The second element is helium. The nucleus contains two protons, and so has a charge of +2. The nuclear charge of +2 is balanced by two negatively charged orbital electrons. The nucleus also contains two neutrons, which minimize the repulsion between the protons in the nucleus, and increase the mass of the atom. All nuclei heavier than hydrogen contain neutrons, but the number present cannot be predicted reliably.

This pattern is repeated for the rest of the elements. Element 3, lithium, has three protons in the nucleus (plus some neutrons). The nuclear charge is +3 and is balanced by three orbital electrons. Element 103, lawrencium, has 103 protons in the nucleus (plus some neutrons). The nuclear charge is +103 and is balanced by 103 orbital electrons. The number of positive charges on the nucleus of an atom always equals the number of orbital electrons, and is called the atomic number of the element.

In the simple planetary theory of the atom, we imagine that these electrons move round the nucleus in circular orbits, in much the same way as the planets orbit round the sun. Thus hydrogen and helium (Figure 1.1) have one and two electrons respectively in their first orbit. The first orbit is then full. The next eight atoms are lithium, beryllium, boron, carbon,

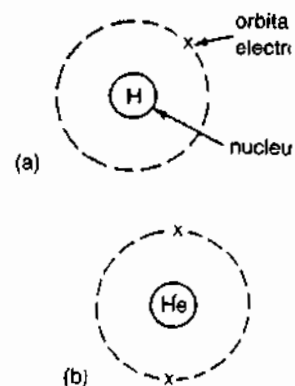

Figure 1.1 Structures of (a) hydrogen, symbol H, atomic number 1; and (b) helium, symbol He, atomic number 2.

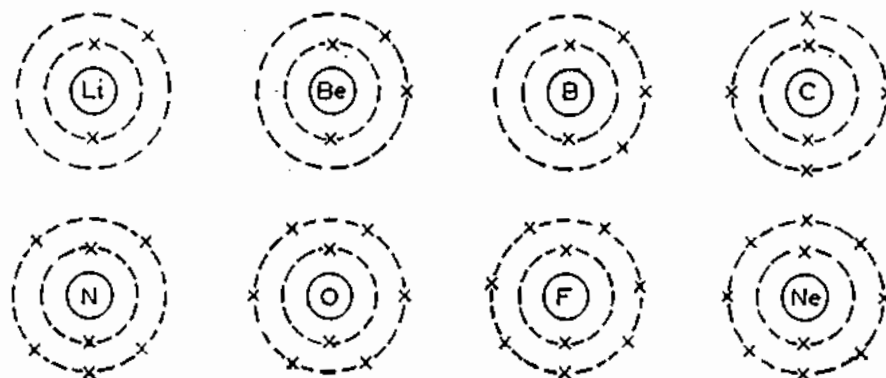

Figure 1.2 Structures of the elements lithium to neon.

nitrogen, oxygen, fluorine and neon. Each has one more proton in the nucleus than the preceding element, and the extra electrons go into a second orbit (Figure 1.2). This orbit is then full. In the next eight elements (with atomic numbers 11 to 18), the additional electrons enter a third shell.

The negatively charged electrons are attracted to the positive nucleus by electrostatic attraction. An electron near the nucleus is strongly attracted by the nucleus and has a low potential energy. An electron distant from the nucleus is less firmly held and has a high potential energy.

#### ATOMIC SPECTRA OF HYDROGEN AND THE BOHR THEORY

When atoms are heated or subjected to an electric discharge, they absorb energy, which is subsequently emitted as radiation. For example, if sodium chloride is heated in the flame of a Bunsen burner, sodium atoms are produced which give rise to the characteristic yellow flame coloration. (There are two lines in the emission spectrum of sodium corresponding to wavelengths of 589.0 nm and 589.6 nm.) Spectroscopy is a study of either the radiation absorbed or the radiation emitted. Atomic spectroscopy is an important technique for studying the energy and the arrangement of electrons in atoms.

If a discharge is passed through hydrogen gas ( $H_2$ ) at a low pressure, some hydrogen atoms (H) are formed, which emit light in the visible region. This light can be studied with a spectrometer, and is found to comprise a series of lines of different wavelengths. Four lines can be seen by eye, but many more are observed photographically in the ultraviolet region. The lines become increasingly close together as the wavelength ( $\lambda$ ) decreases, until the continuum is reached (Figure 1.3). Wavelengths, in metres, are related to the frequency,  $\nu$ , in Hertz (cycles/second) by the equation:

$$\nu = \frac{c}{\lambda}$$

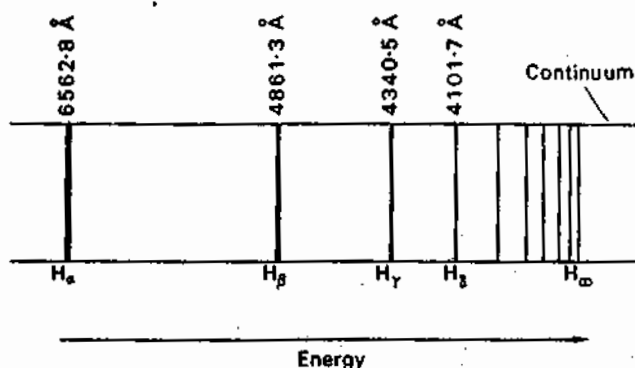

Figure 1.3 Spectrum of hydrogen in the visible region (Balmer series.)

where  $c$  is the velocity of light ( $2.9979 \times 10^8 \text{ ms}^{-1}$ ). In spectroscopy, frequencies are generally expressed as wave numbers  $\bar{\nu}$ , where  $\bar{\nu} = 1/\lambda \text{ m}^{-1}$ .

In 1885 Balmer showed that the wave number  $\bar{\nu}$  of any line in the visible spectrum of atomic hydrogen could be given by the simple empirical formula:

$$\bar{\nu} = R \left( \frac{1}{2^2} - \frac{1}{n^2} \right)$$

where  $R$  is the Rydberg constant and  $n$  has the values 3, 4, 5, ..., thus giving a series of lines.

The lines observed in the visible region are called the Balmer series, but several other series of lines may be observed in different regions of the spectrum (Table 1.1).

Similar equations were found to hold for the lines in the other series in the hydrogen spectrum.

$$\text{Lyman} \quad \bar{\nu} = R \left( \frac{1}{1^2} - \frac{1}{n^2} \right) \quad n = 2, 3, 4, 5, \dots$$

$$\text{Balmer} \quad \bar{\nu} = R \left( \frac{1}{2^2} - \frac{1}{n^2} \right) \quad n = 3, 4, 5, 6, \dots$$

Table 1.1 Spectral series found in atomic hydrogen

	Region of spectrum
Lyman series	ultraviolet
Balmer series	visible/ultraviolet
Paschen series	infrared
Brackett series	infrared
Pfund series	infrared
Humphries series	infrared

$$\text{Paschen } \bar{\nu} = R \left( \frac{1}{3^2} - \frac{1}{n^2} \right) \quad n = 4, 5, 6, 7 \dots$$

$$\text{Brackett } \bar{\nu} = R \left( \frac{1}{4^2} - \frac{1}{n^2} \right) \quad n = 5, 6, 7, 8 \dots$$

$$\text{Pfund } \bar{\nu} = R \left( \frac{1}{5^2} - \frac{1}{n^2} \right) \quad n = 6, 7, 8, 9 \dots$$

In the early years of this century, attempts were made to obtain a physical picture of the atom from this and other evidence. Thomson had shown in 1896 that the application of a high electrical potential across a gas gave electrons, suggesting that these were present in atoms. Rutherford suggested from alpha particle scattering experiments that an atom consisted of a heavy positively charged nucleus with a sufficient number of electrons round it to make the atom electrically neutral. In 1913, Niels Bohr combined these ideas and suggested that the atomic nucleus was surrounded by electrons moving in orbits like planets round the sun. He was awarded the Nobel Prize for Physics in 1922 for his work on the structure of the atom. Several problems arise with this concept:

1. The electrons might be expected to slow down gradually.
2. Why should electrons move in an orbit round the nucleus?
3. Since the nucleus and electrons have opposite charges, they should attract each other. Thus one would expect the electrons to spiral inwards until eventually they collide with the nucleus.

To explain these problems Bohr postulated:

1. An electron did not radiate energy if it stayed in one orbit, and therefore did not slow down.
2. When an electron moved from one orbit to another it either radiated or absorbed energy. If it moved towards the nucleus energy was radiated and if it moved away from the nucleus energy was absorbed.
3. For an electron to remain in its orbit the electrostatic attraction between the electron and the nucleus which tends to pull the electron towards the nucleus must be equal to the centrifugal force which tends to throw the electron out of its orbit. For an electron of mass  $m$ , moving with a velocity  $v$  in an orbit of radius  $r$

$$\text{centrifugal force} = \frac{mv^2}{r}$$

If the charge on the electron is  $e$ , the number of charges on the nucleus  $Z$ , and the permittivity of a vacuum  $\epsilon_0$

$$\text{Coulombic attractive force} = \frac{Ze^2}{4\pi\epsilon_0 r^2}$$

so



$$\frac{mv^2}{r} = \frac{Ze^2}{4\pi\epsilon_0 r^2} \quad (1.1)$$

hence

$$v^2 = \frac{Ze^2}{4\pi\epsilon_0 mr} \quad (1.2)$$

According to Planck's quantum theory, energy is not continuous but is discrete. This means that energy occurs in 'packets' called quanta, of magnitude  $h/2\pi$ , where  $h$  is Planck's constant. The energy of an electron in an orbit, that is its angular momentum  $mvr$ , must be equal to a whole number  $n$  of quanta.

$$mvr = \frac{nh}{2\pi}$$

$$v = \frac{nh}{2\pi mr}$$

$$v^2 = \frac{n^2 h^2}{4\pi^2 m^2 r^2}$$

Combining this with equation (1.2)

$$\frac{Ze^2}{4\pi\epsilon_0 mr} = \frac{n^2 h^2}{4\pi^2 m^2 r^2}$$

hence

$$r = \frac{\epsilon_0 n^2 h^2}{\pi m e^2 Z} \quad (1.3)$$

For hydrogen the charge on the nucleus  $Z = 1$ , and if

$$n = 1 \text{ this gives a value } r = 1^2 \times 0.0529 \text{ nm}$$

$$n = 2 \quad \quad \quad r = 2^2 \times 0.0529 \text{ nm}$$

$$n = 3 \quad \quad \quad r = 3^2 \times 0.0529 \text{ nm}$$

This gives a picture of the hydrogen atom where an electron moves in circular orbits of radius proportional to  $1^2, 2^2, 3^2, \dots$ . The atom will only radiate energy when the electron jumps from one orbit to another. The kinetic energy of an electron is  $\frac{1}{2}mv^2$ . Rearranging equation (1.1)

$$E = -\frac{1}{2}mv^2 = -\frac{Ze^2}{8\pi\epsilon_0 r}$$

Substituting for  $r$  using equation (1.3)

$$E = -\frac{Z^2 e^4 m}{8\epsilon_0^2 n^2 h^2}$$

If an electron jumps from an initial orbit  $i$  to a final orbit  $f$ , the change in energy  $\Delta E$  is

$$\Delta E = \left( -\frac{Z^2 e^4 m}{8\epsilon_0^2 n_f^2 h^2} \right) - \left( -\frac{Z^2 e^4 m}{8\epsilon_0^2 n_i^2 h^2} \right)$$

$$= \frac{Z^2 e^4 m}{8\epsilon_0^2 h^2} \left( \frac{1}{n_i^2} - \frac{1}{n_f^2} \right)$$

Energy is related to wavelength ( $E = hc\bar{\nu}$  so this equation is of the same form as the Rydberg equation:

$$\bar{\nu} = \frac{Z^2 e^4 m}{8\epsilon_0^2 h^3 c} \left( \frac{1}{n_i^2} - \frac{1}{n_f^2} \right) \quad (1.4)$$

$$\bar{\nu} = R \left( \frac{1}{n_i^2} - \frac{1}{n_f^2} \right) \quad (\text{Rydberg equation})$$

Thus the Rydberg constant

$$R = \frac{Z^2 e^4 m}{8\epsilon_0^2 h^3 c}$$

The experimental value of  $R$  is  $1.097373 \times 10^7 \text{ m}^{-1}$ , in good agreement with the theoretical value of  $1.096776 \times 10^7 \text{ m}^{-1}$ . The Bohr theory provides an explanation of the atomic spectra of hydrogen. The different series of spectral lines can be obtained by varying the values of  $n_i$  and  $n_f$  in equation (1.4). Thus with  $n_f = 1$  and  $n_i = 2, 3, 4, \dots$  we obtain the Lyman series of lines in the UV region. With  $n_f = 2$  and  $n_i = 3, 4, 5, \dots$  we get the Balmer series of lines in the visible spectrum. Similarly,  $n_f = 3$  and  $n_i = 4, 5, 6, \dots$  gives the Paschen series,  $n_f = 4$  and  $n_i = 5, 6, 7, \dots$  gives the Brackett series, and  $n_f = 6$  and  $n_i = 7, 8, 9, \dots$  gives the Pfund series. The various transitions which are possible between orbits are shown in Figure 1.4.

### REFINEMENTS TO THE BOHR THEORY

It has been assumed that the nucleus remains stationary except for rotating on its own axis. This would be true if the mass of the nucleus were infinite, but the ratio of the mass of an electron to the mass of the hydrogen nucleus is  $1/1836$ . The nucleus actually oscillates slightly about the centre of gravity, and to allow for this the mass of the electron  $m$  is replaced by the reduced mass  $\mu$  in equation (1.4):

$$\mu = \frac{mM}{m + M}$$

where  $M$  is the mass of the nucleus. The inclusion of the mass of the nucleus explains why different isotopes of an element produce lines in the spectrum at slightly different wavenumbers.

The orbits are sometimes denoted by the letters K, L, M, N... counting outwards from the nucleus, and they are also numbered 1, 2, 3, 4... This number is called the principal quantum number, which is given the symbol

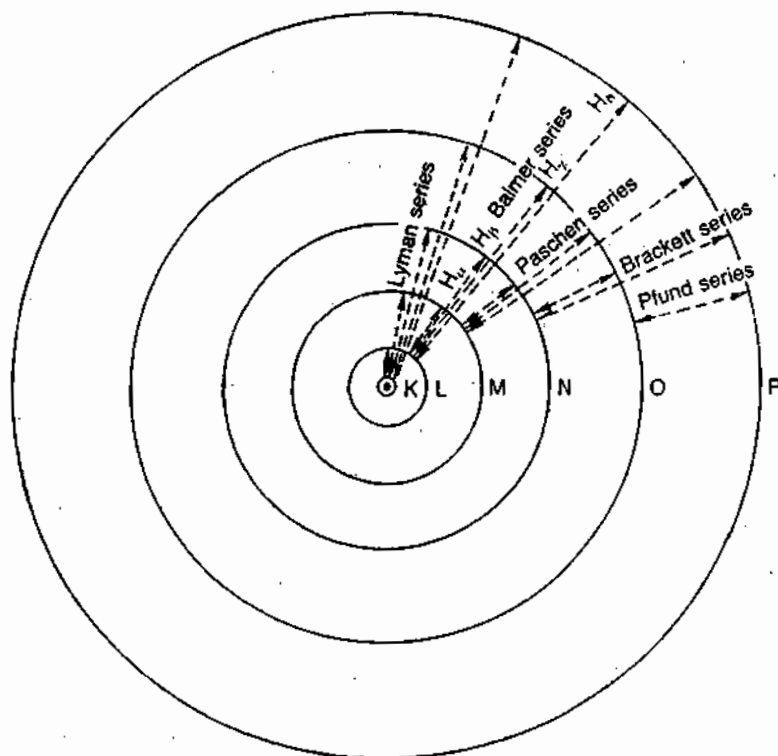

Figure 1.4 Bohr orbits of hydrogen and the various series of spectral lines.

$n$ . It is therefore possible to define which circular orbit is under consideration by specifying the principal quantum number.

When an electron moves from one orbit to another it should give a single sharp line in the spectrum, corresponding precisely to the energy difference between the initial and final orbits. If the hydrogen spectrum is observed with a high resolution spectrometer it is found that some of the lines reveal 'fine structure'. This means that a line is really composed of several lines close together. Sommerfeld explained this splitting of lines by assuming that some of the orbits were elliptical, and that they precessed in space round the nucleus. For the orbit closest to the nucleus, the principal quantum number  $n = 1$ , and there is a circular orbit. For the next orbit, the principal quantum number  $n = 2$ , and both circular and elliptical orbits are possible. To define an elliptical orbit, a second quantum number  $k$  is needed. The shape of the ellipse is defined by the ratio of the lengths of the major and minor axes. Thus

$$\frac{\text{major axis}}{\text{minor axis}} = \frac{n}{k}$$

$k$  is called the azimuthal or subsidiary quantum number, and may have values from 1, 2, ...  $n$ . Thus for  $n = 2$ ,  $n/k$  may have the values 2/2 (circular

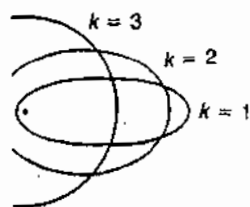

Fig. 1.5 Bohr-Sommerfeld orbits for  $n = 3$ .

orbit) and 2/1 (elliptical orbit). For the principal quantum number  $n = 3$ ,  $n/k$  may have values 3/3 (circular), 3/2 (ellipse) and 3/1 (narrower ellipse).

The presence of these extra orbits, which have slightly different energies from each other, accounts for the extra lines in the spectrum revealed under high resolution. The original quantum number  $k$  has now been replaced by a new quantum number  $l$ , where  $l = k - 1$ . Thus for

$$\begin{aligned} n = 1 & \quad l = 0 \\ n = 2 & \quad l = 0 \text{ or } 1 \\ n = 3 & \quad l = 0 \text{ or } 1 \text{ or } 2 \\ n = 4 & \quad l = 0 \text{ or } 1 \text{ or } 2 \text{ or } 3 \end{aligned}$$

This explained why some of the spectral lines are split into two, three, four or more lines. In addition some spectral lines are split still further into two lines (a doublet). This is explained by assuming that an electron spins on its axis in either a clockwise or an anticlockwise direction. Energy is quantized, and the value of the spin angular momentum was first considered to be  $m_s \cdot h/2\pi$ , where  $m_s$  is the spin quantum number with values of  $\pm\frac{1}{2}$ . (Quantum mechanics has since shown the exact expression to be  $\sqrt{s(s+1)} \cdot h/2\pi$ , where  $s$  is either the spin quantum number or the resultant of several spins.)

Zeeman showed that if atoms were placed in a strong magnetic field additional lines appeared on the spectrum. This is because elliptical orbits can only take up certain orientations with respect to the external field, rather than precessing freely. Each of these orientations is associated with a fourth quantum number  $m$  which can have values of  $l, (l-1), \dots, 0, \dots, (-l+1), -l$ .

Thus a single line in the normal spectrum will appear as  $(2l+1)$  lines if a magnetic field is applied.

Thus in order to explain the spectrum of the hydrogen atom, four quantum numbers are needed, as shown in Table 1.2. The spectra of other atoms may be explained in a similar manner.

### THE DUAL NATURE OF ELECTRONS – PARTICLES OR WAVES

The planetary theory of atomic structure put forward by Rutherford and Bohr describes the atom as a central nucleus surrounded by electrons in

Table 1.2 The four main quantum numbers

	Symbol	Values
Principal quantum number	$n$	1, 2, 3, ...
Azimuthal or subsidiary quantum number	$l$	0, 1, ... $(n-1)$
Magnetic quantum number	$m$	$-l, \dots, 0, \dots, +l$
Spin quantum number	$m_s$	$\pm\frac{1}{2}$

certain orbits. The electron is thus considered as a particle. In the 1920s it was shown that moving particles such as electrons behaved in some ways as waves. This is an important concept in explaining the electronic structure of atoms.

For some time light has been considered as either particles or waves. Certain materials such as potassium emit electrons when irradiated with visible light, or in some cases with ultraviolet light. This is called the photoelectric effect. It is explained by light travelling as particles called photons. If a photon collides with an electron, it can transfer its energy to the electron. If the energy of the photon is sufficiently large it can remove the electron from the surface of the metal. However, the phenomena of diffraction and interference of light can only be explained by assuming that light behaves as waves. In 1924, de Broglie postulated that the same dual character existed with electrons - sometimes they are considered as particles, and at other times it is more convenient to consider them as waves. Experimental evidence for the wave nature of electrons was obtained when diffraction rings were observed photographically when a stream of electrons was passed through a thin metal foil. Electron diffraction has now become a useful tool in determining molecular structure, particularly of gases. Wave mechanics is a means of studying the build-up of electron shells in atoms, and the shape of orbitals occupied by the electrons.

### THE HEISENBERG UNCERTAINTY PRINCIPLE

Calculations on the Bohr model of an atom require precise information about the position of an electron and its velocity. It is difficult to measure both quantities accurately at the same time. An electron is too small to see and may only be observed if perturbed. For example, we could hit the electron with another particle such as a photon or an electron, or we could apply an electric or magnetic force to the electron. This will inevitably change the position of the electron, or its velocity and direction. Heisenberg stated that the more precisely we can define the position of an electron, the less certainly we are able to define its velocity, and vice versa. If  $\Delta x$  is the uncertainty in defining the position and  $\Delta v$  the uncertainty in the velocity, the uncertainty principle may be expressed mathematically as:

$$\Delta x \cdot \Delta v \geq \frac{h}{4\pi}$$

where  $h$  = Planck's constant =  $6.6262 \times 10^{-34}$  J s. This implies that it is impossible to know both the position and the velocity exactly.

The concept of an electron following a definite orbit, where its position and velocity are known exactly, must therefore be replaced by the probability of finding an electron in a particular position, or in a particular volume of space. The Schrödinger wave equation provides a satisfactory description of an atom in these terms. Solutions to the wave equation are

called wave functions and given the symbol  $\psi$ . The probability of finding an electron at a point in space whose coordinates are  $x$ ,  $y$  and  $z$  is  $\psi^2(x, y, z)$ .

### THE SCHRÖDINGER WAVE EQUATION

For a standing wave (such as a vibrating string) of wavelength  $\lambda$ , whose amplitude at any point along  $x$  may be described by a function  $f(x)$ , it can be shown that:

$$\frac{d^2f(x)}{dx^2} = -\frac{4\pi^2}{\lambda^2} f(x)$$

If an electron is considered as a wave which moves in only one dimension then:

$$\frac{d^2\psi}{dx^2} = -\frac{4\pi^2}{\lambda^2} \psi$$

An electron may move in three directions  $x$ ,  $y$  and  $z$  so this becomes

$$\frac{\partial^2\psi}{\partial x^2} + \frac{\partial^2\psi}{\partial y^2} + \frac{\partial^2\psi}{\partial z^2} = -\frac{4\pi^2}{\lambda^2} \psi$$

Using the symbol  $\nabla$  instead of the three partial differentials, this is shortened to

$$\nabla^2\psi = -\frac{4\pi^2}{\lambda^2} \psi$$

The de Broglie relationship states that

$$\lambda = \frac{h}{mv}$$

(where  $h$  is Planck's constant,  $m$  is the mass of an electron and  $v$  its velocity); hence:

$$\nabla^2\psi = -\frac{4\pi^2m^2v^2}{h^2} \psi$$

or

$$\nabla^2\psi + \frac{4\pi^2m^2v^2}{h^2} \psi = 0 \quad (1.5)$$

However, the total energy of the system  $E$  is made up of the kinetic energy  $K$  plus the potential energy  $V$

$$E = K + V$$

so

$$K = E - V$$

But the kinetic energy  $= \frac{1}{2}mv^2$  so

$$\frac{1}{2}mv^2 = E - V$$

and

$$v^2 = \frac{2}{m}(E - V)$$

Substituting for  $v^2$  in equation (1.5) gives the well-known form of the Schrödinger equation

$$\nabla^2\psi + \frac{8\pi^2m}{h^2}(E - V)\psi = 0$$

Acceptable solutions to the wave equation, that is solutions which are physically possible, must have certain properties:

1.  $\psi$  must be continuous.
2.  $\psi$  must be finite.
3.  $\psi$  must be single valued.
4. The probability of finding the electron over all the space from plusinfinity to minus infinity must be equal to one.

The probability of finding an electron at a point  $x, y, z$  is  $\psi^2$ , so

$$\int_{-\infty}^{+\infty} \psi^2 dx dy dz = 1$$

Several wave functions called  $\psi_1, \psi_2, \psi_3, \dots$  will satisfy these conditions to the wave equation, and each of these has a corresponding energy  $E_1, E_2, E_3, \dots$ . Each of these wave functions  $\psi_1, \psi_2$ , etc. is called an *orbital*, by analogy with the *orbits* in the Bohr theory. In a hydrogen atom, the single electron normally occupies the lowest of the energy levels  $E_1$ . This is called the ground state. The corresponding wave function  $\psi_1$  describes the orbital, that is the volume in space where there is a high probability of finding the electron.

For a given type of atom, there are a number of solutions to the wave equation which are acceptable, and each orbital may be described uniquely by a set of three quantum numbers,  $n, l$  and  $m$ . (These are the same quantum numbers – principal, subsidiary and magnetic – as were used in the Bohr theory).

The subsidiary quantum number  $l$  describes the shape of the orbital occupied by the electron.  $l$  may have values 0, 1, 2 or 3. When  $l = 0$ , the orbital is spherical and is called an *s* orbital; when  $l = 1$ , the orbital is dumb-bell shaped and is called a *p* orbital; when  $l = 2$ , the orbital is double dumb-bell shaped and is called a *d* orbital; and when  $l = 3$  a more complicated *f* orbital is formed (see Figure 1.6). The letters *s, p, d* and *f* come from the spectroscopic terms sharp, principal, diffuse and fundamental, which were used to describe the lines in the atomic spectra.

Examination of a list of all the allowed solutions to the wave equation shows that the orbitals fall into groups.

In the first group of solutions the value of the wave function  $\psi$ , and

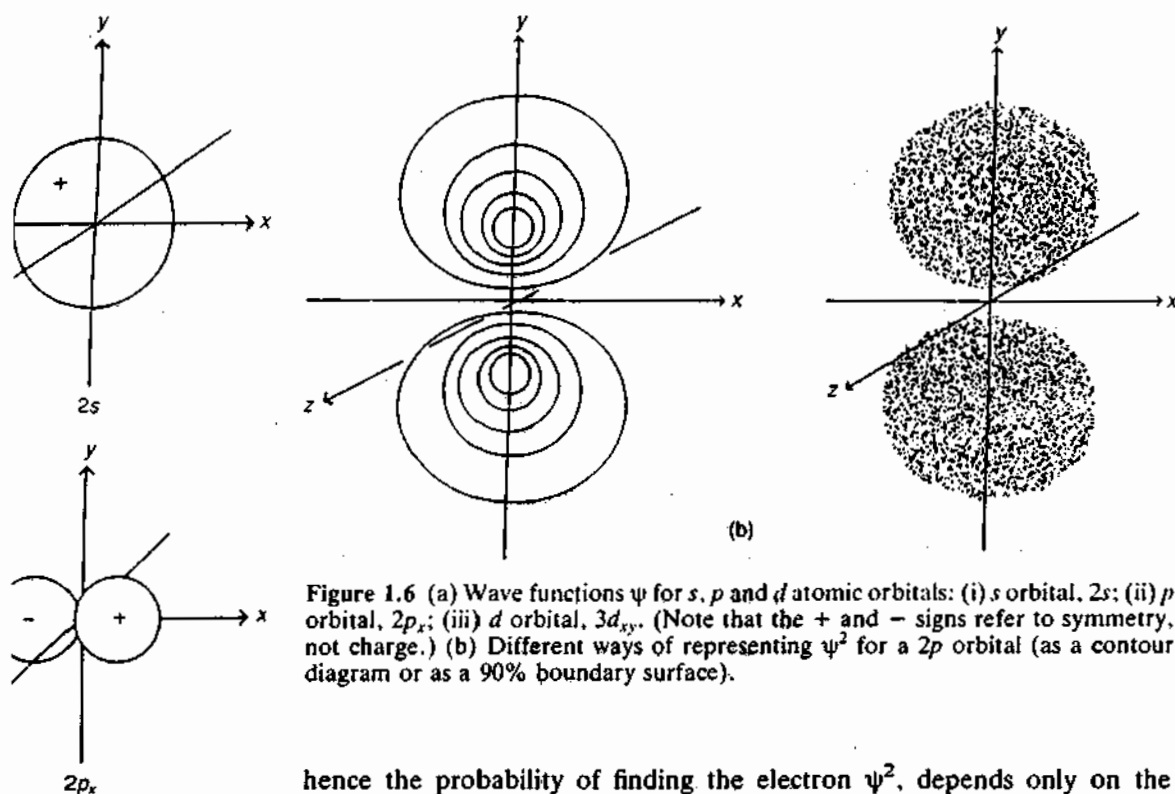

Figure 1.6 (a) Wave functions  $\psi$  for  $s$ ,  $p$  and  $d$  atomic orbitals: (i)  $s$  orbital,  $2s$ ; (ii)  $p$  orbital,  $2p_x$ ; (iii)  $d$  orbital,  $3d_{xy}$ . (Note that the + and - signs refer to symmetry, not charge.) (b) Different ways of representing  $\psi^2$  for a  $2p$  orbital (as a contour diagram or as a 90% boundary surface).

hence the probability of finding the electron  $\psi^2$ , depends only on the distance  $r$  from the nucleus, and is the same in all directions.

$$\psi = f(r)$$

This leads to a spherical orbital, and occurs when the subsidiary quantum number  $l$  is zero. These are called  $s$  orbitals. When  $l = 0$ , the magnetic quantum number  $m = 0$ , so there is only one such orbital for each value of  $n$ .

In the second group of solutions to the wave equation,  $\psi$  depends both on the distance from the nucleus, and on the direction in space ( $x$ ,  $y$  or  $z$ ). Orbitals of this kind occur when the subsidiary quantum number  $l = 1$ . These are called  $p$  orbitals and there are three possible values of the magnetic quantum number ( $m = -1, 0$  and  $+1$ ). There are therefore three orbitals which are identical in energy, shape and size, which differ only in their direction in space. These three solutions to the wave equation may be written

$$\psi_x = f(r) \cdot f(x)$$

$$\psi_y = f(r) \cdot f(y)$$

$$\psi_z = f(r) \cdot f(z)$$

Orbitals that are identical in energy are termed degenerate, and thus three degenerate  $p$  orbitals occur for each of the values of  $n = 2, 3, 4, \dots$

The third group of solutions to the wave equation depend on the

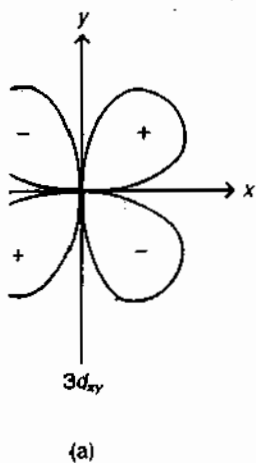



Table 1.3 Atomic orbitals

Principal quantum number $n$	Subsidiary quantum number $l$	Magnetic quantum numbers $m$	Symbol
1	0	0	1s (one orbital)
2	0	0	2s (one orbital)
2	1	-1, 0, +1	2p (three orbitals)
3	0	0	3s (one orbital)
3	1	-1, 0, +1	3p (three orbitals)
3	2	-2, -1, 0, +1, +2	3d (five orbitals)
4	0	0	4s (one orbital)
4	1	-1, 0, +1	4p (three orbitals)
4	2	-2, -1, 0, +1, +2	4d (five orbitals)
4	3	-3, -2, -1, 0, +1, +2, -3	4f (seven orbitals)

distance from the nucleus  $r$  and also on two directions in space, for example

$$\psi = f(r) \cdot f(x) \cdot f(y)$$

This group of orbitals has  $l = 2$ , and these are called  $d$  orbitals. There are five solutions corresponding to  $m = -2, -1, 0, +1$  and  $+2$ , and these are all equal in energy. Thus five degenerate  $d$  orbitals occur for each of the values of  $n = 3, 4, 5, \dots$

A further set of solutions occurs when  $l = 3$ , and these are called  $f$  orbitals. There are seven values of  $m$ :  $-3, -2, -1, 0, +1, +2$  and  $+3$ , and seven degenerate  $f$  orbitals are formed when  $n = 4, 5, 6, \dots$

## RADIAL AND ANGULAR FUNCTIONS

The Schrödinger equation can be solved completely for the hydrogen atom, and for related ions which have only one electron such as  $\text{He}^+$  and  $\text{Li}^{2+}$ . For other atoms only approximate solutions can be obtained. For most calculations, it is simpler to solve the wave equation if the cartesian coordinates  $x, y$  and  $z$  are converted into polar coordinates  $r, \theta$  and  $\phi$ . The coordinates of the point A measured from the origin are  $x, y$ , and  $z$  in cartesian coordinates, and  $r, \theta$  and  $\phi$  in polar coordinates. It can be seen that the two sets of coordinates are related by the following expressions:

$$\begin{aligned} z &= r \cos \theta \\ y &= r \sin \theta \sin \phi \\ x &= r \sin \theta \cos \phi \end{aligned}$$

The Schrödinger equation is usually written:

$$\nabla^2 \psi + \frac{8\pi^2 m}{h^2} (E - V) \psi = 0$$

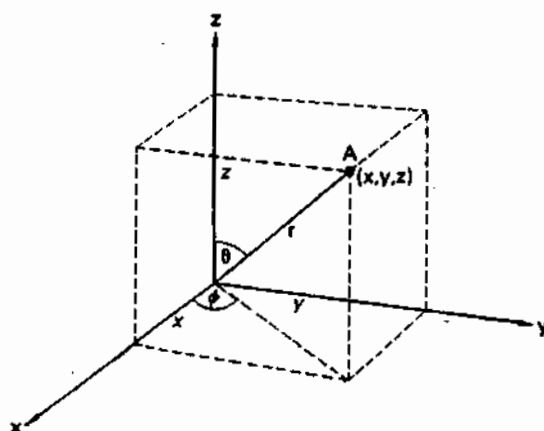

Figure 1.7 The relationship between cartesian and polar coordinates.

where

$$\nabla^2\psi = \frac{\partial^2\psi}{\partial x^2} + \frac{\partial^2\psi}{\partial y^2} + \frac{\partial^2\psi}{\partial z^2}$$

Changing to polar coordinates,  $\nabla^2\psi$  becomes

$$\frac{1}{r^2} \frac{\partial}{\partial r} \left( r^2 \frac{\partial \psi}{\partial r} \right) + \frac{1}{r^2 \sin^2 \theta} \frac{\partial^2 \psi}{\partial \phi^2} + \frac{1}{r^2 \sin \theta} \frac{\partial}{\partial \theta} \left( \sin \theta \frac{\partial \psi}{\partial \theta} \right)$$

The solution of this is of the form

$$\psi = R(r) \cdot \Theta(\theta) \cdot \Phi(\phi) \quad (1.6)$$

$R(r)$  is a function that depends on the distance from the nucleus, which in turn depends on the quantum numbers  $n$  and  $l$

$\Theta(\theta)$  is a function of  $\theta$ , which depends on the quantum numbers  $l$  and  $m$

$\Phi(\phi)$  is a function of  $\phi$ , which depends only on the quantum number  $m$

Equation (1.6) may be rewritten

$$\psi = R(r)_{nl} \cdot A_{ml}$$

This splits the wave function into two parts which can be solved separately:

1.  $R(r)$  the radial function, which depends on the quantum numbers  $n$  and  $l$ .
2.  $A_{ml}$  the total angular wave function, which depends on the quantum numbers  $m$  and  $l$ .

The radial function  $R$  has no physical meaning, but  $R^2$  gives the probability of finding the electron in a small volume  $dv$  near the point at which  $R$  is measured. For a given value of  $r$  the number of small volumes is  $4\pi r^2$ , so the probability of the electron being at a distance  $r$  from the nucleus is  $4\pi r^2 R^2$ . This is called the radial distribution function. Graphs of the

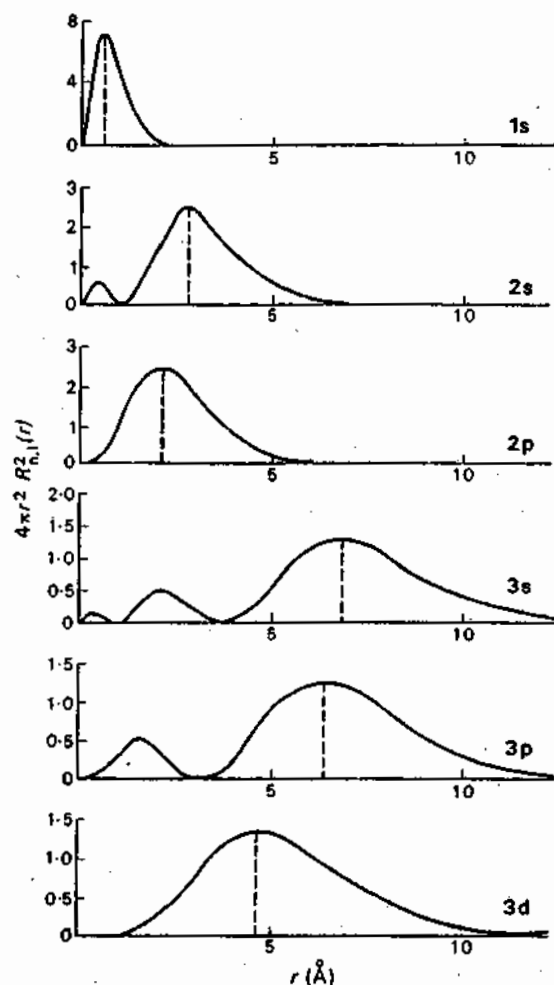

Figure 1.8 Radial distribution functions for various orbitals in the hydrogen atom.

radial distribution function for hydrogen plotted against  $r$  are shown in Figure 1.8.

These diagrams show that the probability is zero at the nucleus (as  $r = 0$ ), and by examining the plots for  $1s$ ,  $2s$  and  $3s$  that the most probable distance increases markedly as the principal quantum number increases. Furthermore, by comparing the plots for  $2s$  and  $2p$ , or  $3s$ ,  $3p$  and  $3d$  it can be seen that the most probable radius decreases slightly as the subsidiary quantum number increases. All the  $s$  orbitals except the first one ( $1s$ ) have a shell-like structure, rather like an onion or a hailstone, consisting of concentric layers of electron density. Similarly, all but the first  $p$  orbitals ( $2p$ ) and the first  $d$  orbitals ( $3d$ ) have a shell structure.

The angular function  $A$  depends only on the direction, and is independent of the distance from the nucleus ( $r$ ). Thus  $A^2$  is the probability of

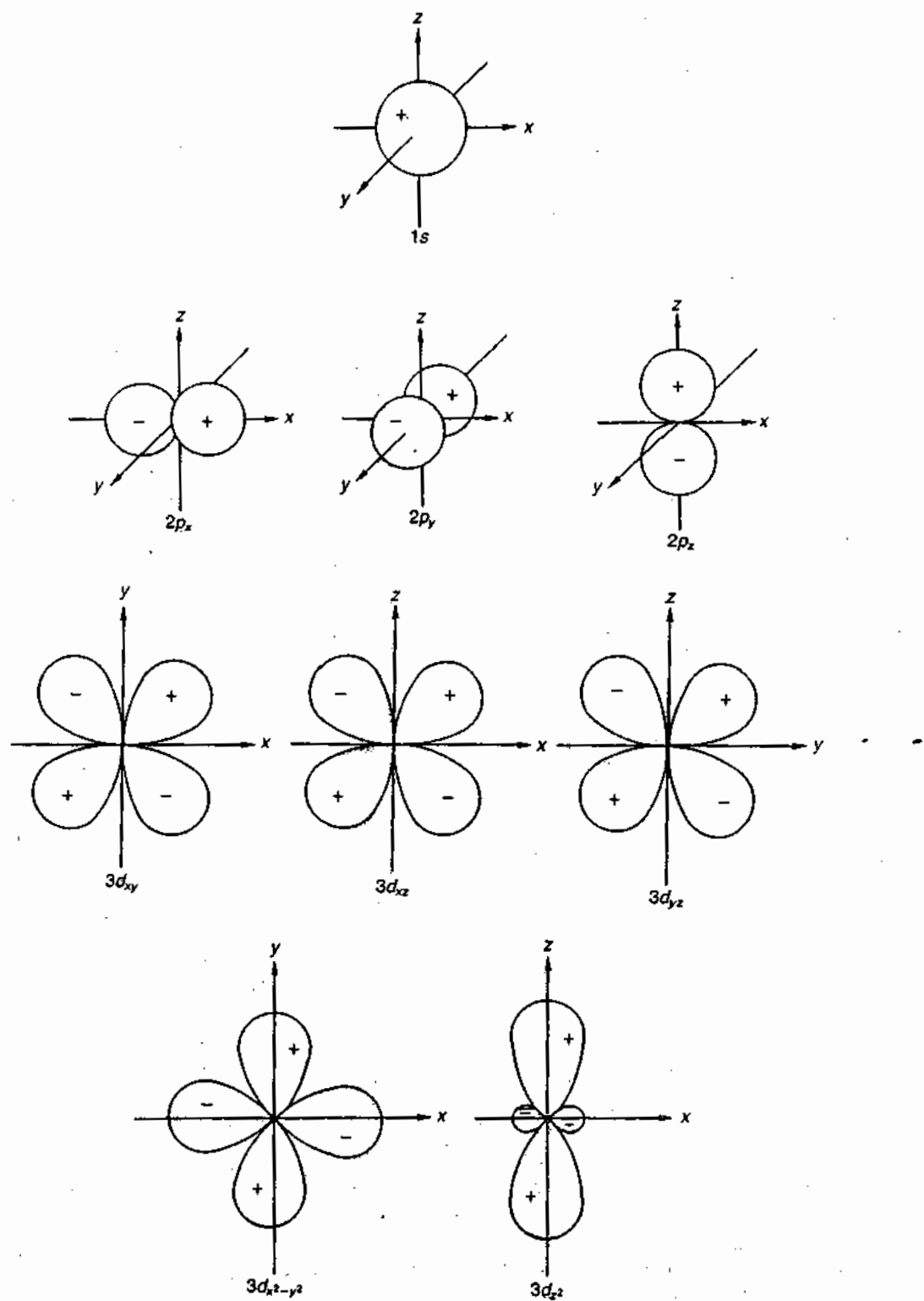

Figure 1.9 Boundary surface for the angular part of the wave function  $A(\theta, \phi)$  for the 2s, 2p and 3d orbitals for a hydrogen atom shown as polar diagrams.

finding an electron at a given direction  $\theta, \phi$  at any distance from the nucleus to infinity. The angular functions  $A$  are plotted as polar diagrams in Figure 1.9. It must be emphasized that *these polar diagrams do not represent the total wave function  $\psi$ , but only the angular part of the wave function.* (The total wave function is made up from contributions from both the radial and the angular functions.)

$$\psi = R(r) \cdot A$$

Thus the probability of finding an electron simultaneously at a distance  $r$  and in a given direction  $\theta, \phi$  is  $\psi_{r,\theta,\phi}^2$ .

$$\psi_{r,\theta,\phi}^2 = R^2(r) \cdot A^2(\theta, \phi)$$

Polar diagrams, that is drawings of the the angular part of the wave function, are commonly used to illustrate the overlap of orbitals giving bonding between atoms. Polar diagrams are quite good for this purpose, as they show the signs + and - relating to the symmetry of the angular function. For bonding like signs must overlap. These shapes are slightly different from the shapes of the total wave function. There are several points about such diagrams:

1. It is difficult to picture an angular wave function as a mathematical equation. It is much easier to visualize a boundary surface, that is a solid shape, which for example contains 90% of the electron density. To emphasize that  $\psi$  is a continuous function, the boundary surfaces have been extended up to the nucleus in Figure 1.9. For  $p$  orbitals the electron density is zero at the nucleus, and some texts show a  $p$  orbital as two spheres which do not touch.
2. These drawings show the symmetry for the  $1s, 2p, 3d$  orbitals. However, in the others,  $2s, 3s, 4s \dots, 3p, 4p, 5p \dots, 4d, 5d \dots$  the sign (symmetry) changes inside the boundary surface of the orbital. This is readily seen as nodes in the graphs of the radial functions (Figure 1.8).

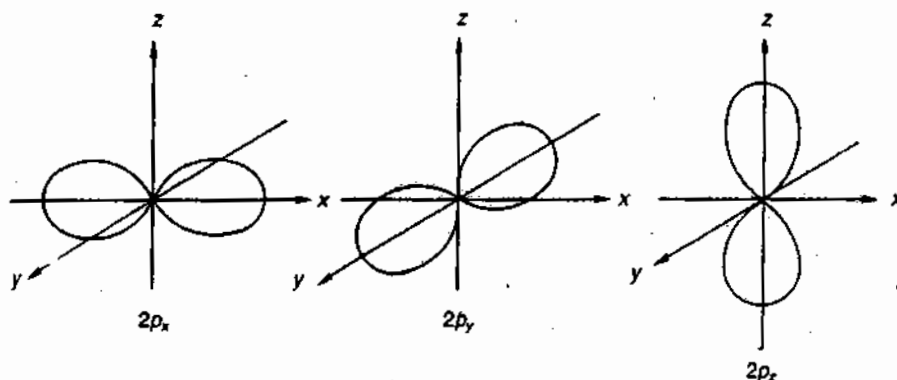

Figure 1.10 The angular part of the wave function squared  $A^2(\theta, \phi)$  for the  $2p$  orbitals for a hydrogen atom.

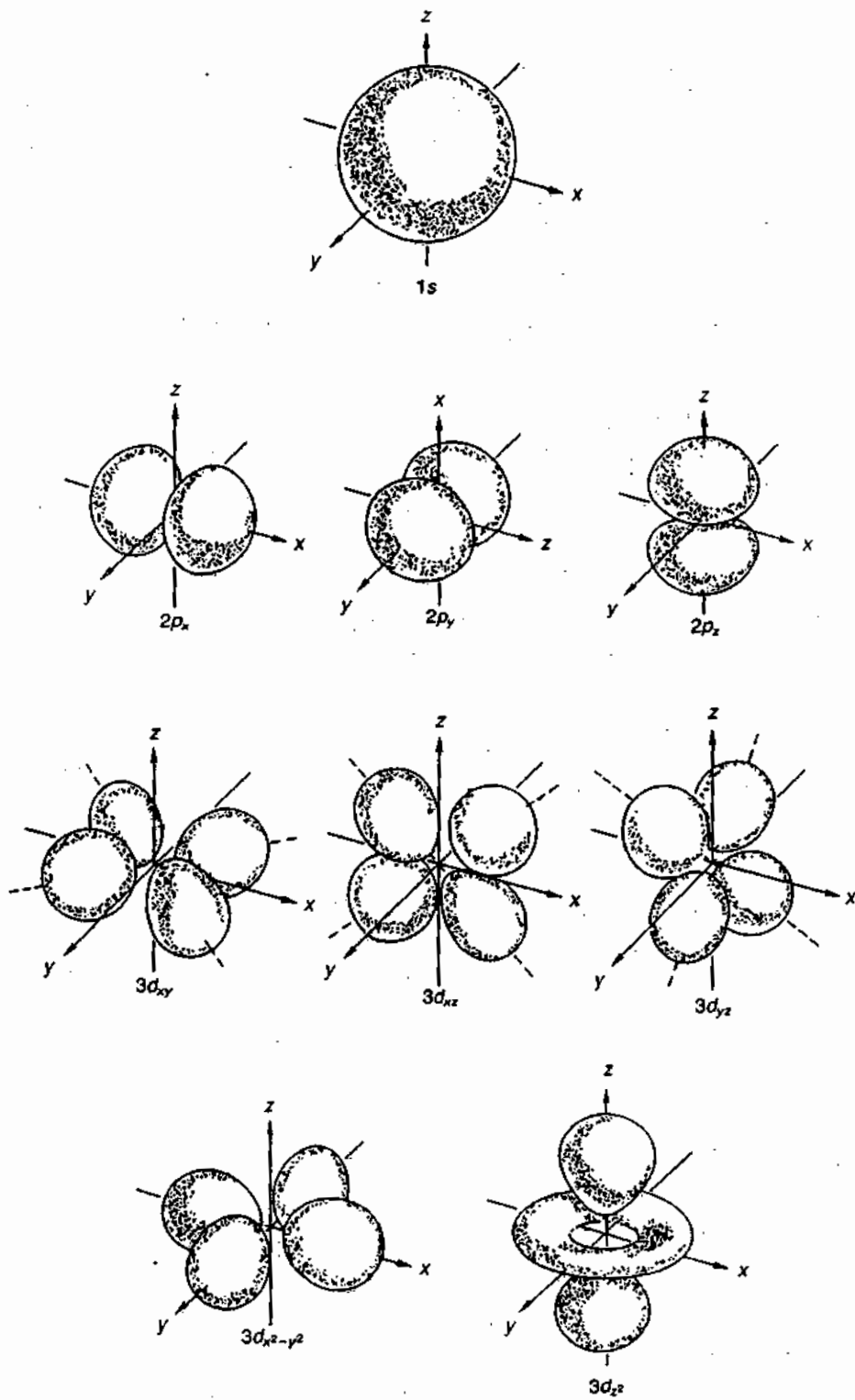

Figure 1.11 Total wave function (orbitals) for hydrogen.

3. The probability of finding an electron at a direction  $\theta, \phi$  is the wave function squared,  $A^2$ , or more precisely  $\psi_\theta^2\psi_\phi^2$ . The diagrams in Figure 1.9 are of the angular part of the wave function  $A$ , not  $A^2$ . Squaring does not change the shape of an  $s$  orbital, but it elongates the lobes of  $p$  orbitals (Figure 1.10). Some books use elongated  $p$  orbitals, but strictly these should **not** have signs, as squaring removes any sign from the symmetry. Despite this, many authors draw shapes approximating to the probabilities, i.e. squared wave functions, and put the signs of the wave function on the lobes, and refer to both the shapes and the wave functions as orbitals.
4. A full representation of the probability of finding an electron requires the total wave function squared and includes both the radial and angular probabilities squared. It really needs a three-dimensional model to display this probability, and show the shapes of the orbitals. It is difficult to do this adequately on a two-dimensional piece of paper, but a representation is shown in Figure 1.11. The orbitals are not drawn to scale. Note that the  $p$  orbitals are not simply two spheres, but are ellipsoids of revolution. Thus the  $2p_x$  orbital is spherically symmetrical about the  $x$  axis, but is not spherical in the other direction. Similarly the  $p_y$  orbital is spherically symmetrical about the  $y$  axis, and both the  $p_z$  and the  $3d_z^2$  are spherically symmetrical about the  $z$  axis.

#### PAULI EXCLUSION PRINCIPLE

Three quantum numbers  $n, l$  and  $m$  are needed to define an orbital. Each orbital may hold up to two electrons, provided they have opposite spins. An extra quantum number is required to define the spin of an electron in an orbital. Thus four quantum numbers are needed to define the energy of an electron in an atom. The Pauli exclusion principle states that no two electrons in one atom can have all four quantum numbers the same. By permutating the quantum numbers, the maximum number of electrons which can be contained in each main energy level can be calculated (see Figure 1.12).

#### BUILD-UP OF THE ELEMENTS, HUND'S RULE

When atoms are in their ground state, the electrons occupy the lowest possible energy levels.

The simplest element, hydrogen, has one electron, which occupies the  $1s$  level; this level has the principal quantum number  $n = 1$ , and the subsidiary quantum number  $l = 0$ .

Helium has two electrons. The second electron also occupies the  $1s$  level. This is possible because the two electrons have opposite spins. This level is now full.

The next atom lithium has three electrons. The third electron occupies the next lowest level. This is the  $2s$  level, which has the principal quantum number  $n = 2$  and subsidiary quantum number  $l = 0$ .

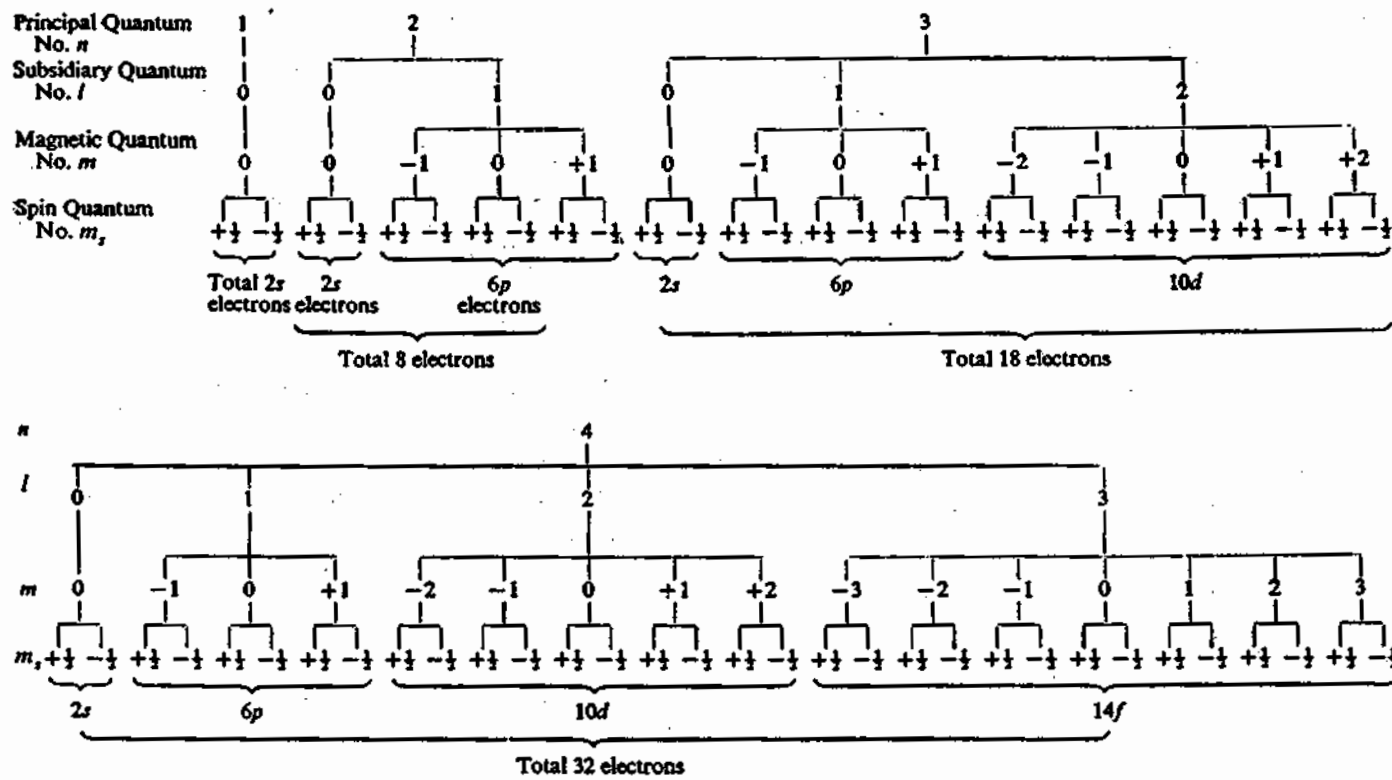

Figure 1.12 Quantum numbers, the permissible number of electrons and the shape of the periodic table.



The fourth electron in beryllium also occupies the  $2s$  level. Boron must have its fifth electron in the  $2p$  level as the  $2s$  level is full. The sixth electron in carbon is also in the  $2p$  level. Hund's rule states that the number of unpaired electrons in a given energy level is a maximum. Thus in the ground state the two  $p$  electrons in carbon are unpaired. They occupy separate  $p$  orbitals and have parallel spins. Similarly in nitrogen the three  $p$  electrons are unpaired and have parallel spins.

To show the positions of the electrons in an atom, the symbols  $1s$ ,  $2s$ ,  $2p$ , etc. are used to denote the main energy level and sub-level. A superscript indicates the number of electrons in each set of orbitals. Thus for hydrogen, the  $1s$  orbital contains one electron, and this is shown as  $1s^1$ . For helium the  $1s$  orbital contains two electrons, denoted  $1s^2$ . The electronic structures of the first few atoms in the periodic table may be written:

H	$1s^1$
He	$1s^2$
Li	$1s^2 2s^1$
Be	$1s^2 2s^2$
B	$1s^2 2s^2 2p^1$
C	$1s^2 2s^2 2p^2$
N	$1s^2 2s^2 2p^3$
O	$1s^2 2s^2 2p^4$
F	$1s^2 2s^2 2p^5$
Ne	$1s^2 2s^2 2p^6$
Na	$1s^2 2s^2 2p^6 3s^1$

An alternative way of showing the electronic structure of an atom is to draw boxes for orbitals, and arrows for the electrons.

Electronic structure of H atom in the ground state	$1s$ ↑	$2s$ □	$2p$ □ □ □
Electronic structure of He atom in the ground state	$1s$ ↑↓	$2s$ □	$2p$ □ □ □
Electronic structure of Li atom in the ground state	$1s$ ↑↓	$2s$ ↑	$2p$ □ □ □
Electronic structure of Be atom in the ground state	$1s$ ↑↓	$2s$ ↑↓	$2p$ □ □ □
Electronic structure of B atom in the ground state	$1s$ ↑↓	$2s$ ↑↓	$2p$ ↑ □ □

Electronic structure of C atom in the ground state	1s ↑↓	2s ↑↓	2p ↑ ↑		
Electronic structure of N atom in the ground state	1s ↑↓	2s ↑↓	2p ↑ ↑ ↑		
Electronic structure of O atom in the ground state	1s ↑↓	2s ↑↓	2p ↑↓ ↑ ↑		
Electronic structure of F atom in the ground state	1s ↑↓	2s ↑↓	2p ↑↓ ↑↓ ↑		
Electronic structure of Ne atom in the ground state	1s ↑↓	2s ↑↓	2p ↑↓ ↑↓ ↑↓	3s □	3p □ □ □
Electronic structure of Na atom in the ground state	1s ↑↓	2s ↑↓	2p ↑↓ ↑↓ ↑↓	3s ↑	3p □ □ □

The process continues in a similar way.

### SEQUENCE OF ENERGY LEVELS

It is important to know the sequence in which the energy levels are filled. Figure 1.13 is a useful aid. From this it can be seen that the order of filling of energy levels is:  $1s$ ,  $2s$ ,  $2p$ ,  $3s$ ,  $3p$ ,  $4s$ ,  $3d$ ,  $4p$ ,  $5s$ ,  $4d$ ,  $5p$ ,  $6s$ ,  $4f$ ,  $5d$ ,  $6p$ ,  $7s$ , etc.

After the  $1s$ ,  $2s$ ,  $2p$ ,  $3s$  and  $3p$  levels have been filled at argon, the next two electrons go into the  $4s$  level. This gives the elements potassium and calcium. Once the  $4s$  level is full the  $3d$  level is the next lowest in energy, not the  $3p$  level. Thus the  $3d$  starts to fill at scandium. The elements from scandium to copper have two electrons in the  $4s$  level and an incomplete  $3d$  level, and all behave in a similar manner chemically. Such a series of atoms is known as a transition series.

A second transition series starts after the  $5s$  orbital has been filled, at strontium, because in the next element, yttrium, the  $4d$  level begins to fill up. A third transition series starts at lanthanum where the electrons start to fill the  $5d$  level after the  $6d$  level has been filled with two electrons.

A further complication arises here because after lanthanum, which has one electron in the  $5d$  level, the  $4f$  level begins to fill, giving the elements from cerium to lutetium with from one to 14  $f$  electrons. These are sometimes called the inner transition elements, but are usually known as the lanthanides or rare earth metals.

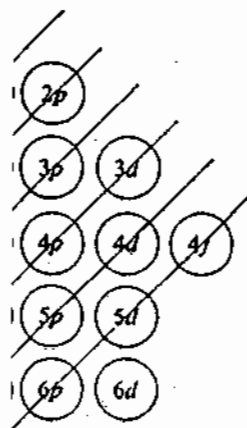

3 Sequence of filling els.

### ARRANGEMENT OF THE ELEMENTS IN GROUPS IN THE PERIODIC TABLE

The chemical properties of an element are largely governed by the number of electrons in the outer shell, and their arrangement. If the elements are arranged in groups which have the same outer electronic arrangement, then elements within a group should show similarities in chemical and physical properties. One great advantage of this is that initially it is only necessary to learn the properties of each group rather than the properties of each individual element.

Elements with one *s* electron in their outer shell are called Group I (the alkali metals) and elements with two *s* electrons in their outer shell are called Group II (the alkaline earth metals). These two groups are known as the *s*-block elements, because their properties result from the presence of *s* electrons.

Elements with three electrons in their outer shell (two *s* electrons and one *p* electron) are called Group III, and similarly Group IV elements have four outer electrons, Group V elements have five outer electrons, Group VI elements have six outer electrons and Group VII elements have seven outer electrons. Group 0 elements have a full outer shell of electrons so that the next shell is empty; hence the group name. Groups III, IV, V, VI, VII and 0 all have *p* orbitals filled and because their properties are dependent on the presence of *p* electrons, they are called jointly the *p*-block elements.

In a similar way, elements where *d* orbitals are being filled are called the *d*-block, or transition elements. In these, *d* electrons are being added to the penultimate shell.

Finally, elements where *f* orbitals are filling are called the *f*-block, and here the *f* electrons are entering the antepenultimate (or second from the outside) shell.

In the periodic table (Table 1.4), the elements are arranged in order of increasing atomic number, that is in order of increased nuclear charge, or increased number of orbital electrons. Thus each element contains one more orbital electron than the preceding element. Instead of listing the 103 elements as one long list, the periodic table arranges them into several horizontal rows or periods, in such a way that each row begins with an alkali metal and ends with a noble gas. The sequence in which the various energy levels are filled determines the number of elements in each period, and the periodic table can be divided into four main regions according to whether the *s*, *p*, *d* or *f* levels are being filled.

1st period	1s			elements in this period 2	
2nd period	2s	2p		elements in this period 8	
3rd period	3s	3p		elements in this period 8	
4th period	4s	3d	4p	elements in this period 18	
5th period	5s	4d	5p	elements in this period 18	
6th period	6s	4f	5d	6p	elements in this period 32

Table 1.4 The periodic table

Period \ Group	s-block		d-block										p-block						
	I	II	III	IV	V	VI	VII	0	III	IV	V	VI	VII	0					
1	<sup>1</sup> H													<sup>1</sup> H	<sup>2</sup> He				
2	<sup>3</sup> Li	<sup>4</sup> Be												<sup>5</sup> B	<sup>6</sup> C	<sup>7</sup> N	<sup>8</sup> O	<sup>9</sup> F	<sup>10</sup> Ne
3	<sup>11</sup> Na	<sup>12</sup> Mg	d-block										<sup>13</sup> Al	<sup>14</sup> Si	<sup>15</sup> P	<sup>16</sup> S	<sup>17</sup> Cl	<sup>18</sup> Ar	
4	<sup>19</sup> K	<sup>20</sup> Ca	<sup>21</sup> Sc	<sup>22</sup> Ti	<sup>23</sup> V	<sup>24</sup> Cr	<sup>25</sup> Mn	<sup>26</sup> Fe	<sup>27</sup> Co	<sup>28</sup> Ni	<sup>29</sup> Cu	<sup>30</sup> Zn	<sup>31</sup> Ga	<sup>32</sup> Ge	<sup>33</sup> As	<sup>34</sup> Se	<sup>35</sup> Br	<sup>36</sup> Kr	
5	<sup>37</sup> Rb	<sup>38</sup> Sr	<sup>39</sup> Y	<sup>40</sup> Zr	<sup>41</sup> Nb	<sup>42</sup> Mo	<sup>43</sup> Tc	<sup>44</sup> Ru	<sup>45</sup> Rh	<sup>46</sup> Pd	<sup>47</sup> Ag	<sup>48</sup> Cd	<sup>49</sup> In	<sup>50</sup> Sn	<sup>51</sup> Sb	<sup>52</sup> Te	<sup>53</sup> I	<sup>54</sup> Xe	
6	<sup>55</sup> Cs	<sup>56</sup> Ba	<sup>57</sup> La	<sup>72</sup> Hf	<sup>73</sup> Ta	<sup>74</sup> W	<sup>75</sup> Re	<sup>76</sup> Os	<sup>77</sup> Ir	<sup>78</sup> Pt	<sup>79</sup> Au	<sup>80</sup> Hg	<sup>81</sup> Tl	<sup>82</sup> Pb	<sup>83</sup> Bi	<sup>84</sup> Po	<sup>85</sup> At	<sup>86</sup> Rn	
7	<sup>87</sup> Fr	<sup>88</sup> Ra	<sup>89</sup> Ac	f-block															
	Lanthanides		<sup>58</sup> Ce	<sup>59</sup> Pr	<sup>60</sup> Nd	<sup>61</sup> Pm	<sup>62</sup> Sm	<sup>63</sup> Eu	<sup>64</sup> Gd	<sup>65</sup> Tb	<sup>66</sup> Dy	<sup>67</sup> Ho	<sup>68</sup> Er	<sup>69</sup> Tm	<sup>70</sup> Yb	<sup>71</sup> Lu			
	Actinides		<sup>90</sup> Th	<sup>91</sup> Pa	<sup>92</sup> U	<sup>93</sup> Np	<sup>94</sup> Pu	<sup>95</sup> Am	<sup>96</sup> Cm	<sup>97</sup> Bk	<sup>98</sup> Cf	<sup>99</sup> Es	<sup>100</sup> Fm	<sup>101</sup> Md	<sup>102</sup> No	<sup>103</sup> Lr			

The alkali metals appear in a vertical column labelled Group I, in which all elements have one *s* electron in their outer shell, and hence have similar properties. Thus when one element in a group reacts with a reagent, the other elements in the group will probably react similarly, forming compounds which have similar formulae. Thus reactions of new compounds and their formulae may be predicted by analogy with known compounds. Similarly the noble gases all appear in a vertical column labelled Group 0, and all have a complete outer shell of electrons. This is called the long form of the periodic table. It has many advantages, the most important being that it emphasizes the similarity of properties within a group and the relation between the group and the electron structure. The *d*-block elements are referred to as the transition elements as they are situated between the *s*- and *p*-blocks.

Hydrogen and helium differ from the rest of the elements because there are no *p* orbitals in the first shell. Helium obviously belongs to Group 0, the noble gases, which are chemically inactive because their outer shell of electrons is full. Hydrogen is more difficult to place in a group. It could be included in Group I because it has one *s* electron in its outer shell, is univalent and commonly forms univalent positive ions. However, hydrogen is not a metal and is a gas whilst Li, Na, K, Rb and Cs are metals and are solids. Similarly, hydrogen could be included in Group VII because it is one electron short of a complete shell, or in Group IV because its outer shell is half full. Hydrogen does not resemble the alkali metals, the halogens or Group IV very closely. Hydrogen atoms are extremely small, and have many unique properties. Thus there is a case for placing hydrogen in a group on its own.

#### FURTHER READING

Karplus, M. and Porter, R.N. (1971) *Atoms and Molecules*, Benjamin, New York.  
Greenwood, N.N. (1980) *Principles of Atomic Orbitals*, Royal Institute of Chemistry Monographs for Teachers No. 8, 3rd ed., London.

#### PROBLEMS

1. Name the first five series of lines that occur in the atomic spectrum of hydrogen. Indicate the region in the electromagnetic spectrum where these series occur, and give a general equation for the wavenumber applicable to all the series.
2. What are the assumptions on which the Bohr theory of the structure of the hydrogen atom is based?
3. Give the equation which explains the different series of lines in the atomic spectrum of hydrogen. Who is the equation named after? Explain the various terms involved.
4. (a) Calculate the radii of the first three Bohr orbits for hydrogen. (Planck's constant  $h = 6.6262 \times 10^{-34}$  J.s; mass of electron

$m = 9.1091 \times 10^{-31}$  kg; charge on electron  $e = 1.60210 \times 10^{-19}$  C;  
permittivity of vacuum  $\epsilon_0 = 8.854185 \times 10^{-12}$  kg<sup>-1</sup> m<sup>-3</sup> A<sup>2</sup>.)

(Answers:  $0.529 \times 10^{-10}$  m;  $2.12 \times 10^{-10}$  m;  $4.76 \times 10^{-10}$  m; that is 0.529 Å, 2.12 Å and 4.76 Å.)

- (b) Use these radii to calculate the velocity of an electron in each of these three orbits.  
(Answers:  $2.19 \times 10^6$  m s<sup>-1</sup>;  $1.09 \times 10^6$  m s<sup>-1</sup>;  $7.29 \times 10^5$  m s<sup>-1</sup>.)
- The Balmer series of spectral lines for hydrogen appear in the visible region. What is the lower energy level that these electronic transitions start from, and what transitions correspond to the spectral lines at 379.0 nm and 430.0 nm respectively?
  - What is the wavenumber and wavelength of the first transition in the Lyman, Balmer and Paschen series in the atomic spectra of hydrogen?
  - Which of the following species does the Bohr theory apply to? (a) H, (b) H<sup>+</sup>, (c) He, (d) He<sup>+</sup>, (e) Li, (f) Li<sup>+</sup>, (g) Li<sup>2+</sup>, (h) Be, (i) Be<sup>+</sup>, (j) Be<sup>2+</sup>, (k) Be<sup>3+</sup>.
  - How does the Bohr theory of the hydrogen atom differ from that of Schrödinger?
  - (a) Write down the general form of the Schrödinger equation and define each of the terms in it.  
(b) Solutions to the wave equation that are physically possible must have four special properties. What are they?
  - What is a radial distribution function? Draw this function for the 1s, 2s, 3s, 2p, 3p and 4p orbitals in a hydrogen atom.
  - Explain (a) the Pauli exclusion principle, and (b) Hund's rule. Show how these are used to specify the electronic arrangements of the first 20 elements in the periodic table.
  - What is an orbital? Draw the shapes of the 1s, 2s, 2p<sub>x</sub>, 2p<sub>y</sub>, 2p<sub>z</sub>, 3d<sub>xy</sub>, 3d<sub>xz</sub>, 3d<sub>yz</sub>, 3d<sub>x<sup>2</sup>-y<sup>2</sup></sub> and 3d<sub>z<sup>2</sup></sub> orbitals.
  - Give the names and symbols of the four quantum numbers required to define the energy of electrons in atoms. What do these quantum numbers relate to, and what numerical values are possible for each? Show how the shape of the periodic table is related to these quantum numbers.
  - The first shell may contain up to 2 electrons, the second shell up to 8, the third shell up to 18, and the fourth shell up to 32. Explain this arrangement in terms of quantum numbers.
  - Give the values of the four quantum numbers for each electron in the ground state for (a) the oxygen atom, and (b) the scandium atom. (Use positive values for  $m_l$  and  $m_s$  first.)

16. Give the sequence in which the energy levels in an atom are filled with electrons. Write the electronic configurations for the elements of atomic number 6, 11, 17 and 25, and from this decide to which group in the periodic table each element belongs.
17. Give the name and symbol for each of the atoms which have the ground state electronic configurations in their outer shells: (a)  $2s^2$ , (b)  $3s^23p^5$ , (c)  $3s^23p^64s^2$ , (d)  $3s^23p^63d^64s^2$ , (e)  $5s^25p^2$ , (f)  $5s^25p^6$ .

# 2

## Introduction to bonding

### ATTAINMENT OF A STABLE CONFIGURATION

How do atoms combine to form molecules and why do atoms form bonds? A molecule will only be formed if it is more stable, and has a lower energy, than the individual atoms.

To understand what is happening in terms of electronic structure, consider first the Group 0 elements. These comprise the noble gases, helium, neon, argon, krypton, xenon and radon, which are noteworthy for their chemical inertness. Atoms of the noble gases do not normally react with any other atoms, and their molecules are monatomic, i.e. contain only one atom. The lack of reactivity is because the atoms already have a low energy, and it cannot be lowered further by forming compounds. The low energy of the noble gases is associated with their having a complete outer shell of electrons. This is often called a *noble gas structure*, and it is an exceptionally stable arrangement of electrons.

Normally only electrons in the outermost shell of an atom are involved in forming bonds, and by forming bonds each atom acquires a stable electron configuration. The most stable electronic arrangement is a noble gas structure, and many molecules have this arrangement. However, less stable arrangements than this are commonly attained by transition elements.

### TYPES OF BONDS

Atoms may attain a stable electronic configuration in three different ways: by losing electrons, by gaining electrons, or by sharing electrons.

Elements may be divided into:

1. Electropositive elements, whose atoms give up one or more electrons fairly readily.
2. Electronegative elements, which will accept electrons.
3. Elements which have little tendency to lose or gain electrons.

Three different types of bond may be formed, depending on the electropositive or electronegative character of the atoms involved.



Electropositive element	}	Ionic bond
+		
Electronegative element	}	Covalent bond
+		
Electronegative element	}	Metallic bond
+		
Electropositive element	}	Metallic bond
Electropositive element		

Ionic bonding involves the complete transfer of one or more electrons from one atom to another. Covalent bonding involves the sharing of a pair of electrons between two atoms, and in metallic bonding the valency electrons are free to move throughout the whole crystal.

These types of bonds are idealized or extreme representations, and though one type generally predominates, in most substances the bond type is somewhere between these extreme forms. For example, lithium chloride is considered to be an ionic compound, but it is soluble in alcohol, which suggests that it also possesses a small amount of covalent character. If the three extreme bond types are placed at the corners of a triangle, then compounds with bonds predominantly of one type will be represented as points near the corners. Compounds with bonds intermediate between two types will occur along an edge of the triangle, whilst compounds with bonds showing some characteristics of all three types are shown as points inside the triangle.

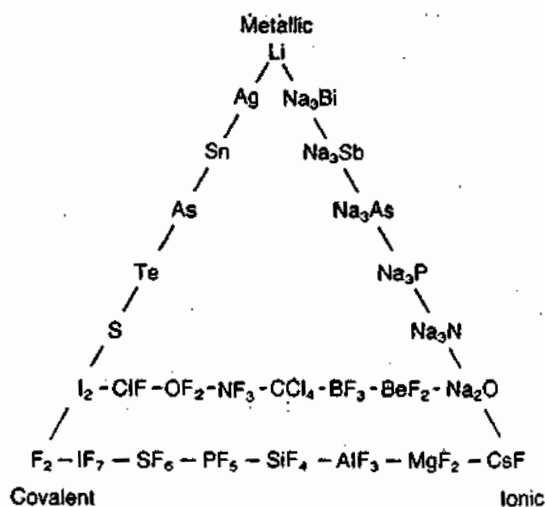

Figure 2.1 Triangle illustrating the transitions between ionic, covalent and metallic bonding. (Reproduced from *Chemical Constitution*, by J. A. A. Ketelaar, Elsevier.)

### TRANSITIONS BETWEEN THE MAIN TYPES OF BONDING

Few bonds are purely ionic, covalent or metallic. Most are intermediate between the three main types, and show some properties of at least two, and sometimes of all three types.

#### Ionic bonds

Ionic bonds are formed when electropositive elements react with electronegative elements.

Consider the ionic compound sodium chloride. A sodium atom has the electronic configuration  $1s^2 2s^2 2p^6 3s^1$ . The first and second shells of electrons are full, but the third shell contains only one electron. When this atom reacts it will do so in such a way that it attains a stable electron configuration. The noble gases have a stable electron arrangement and the nearest noble gas to sodium is neon, whose configuration is  $1s^2 2s^2 2p^6$ . If the sodium atom can lose one electron from its outer shell, it will attain this configuration and in doing so the sodium acquires a net charge of +1 and is called a sodium ion  $\text{Na}^+$ . The positive charge arises because the nucleus contains 11 protons, each with a positive charge, but there are now only 10 electrons. Sodium atoms tend to lose an electron in this way when they are supplied with energy, and so sodium is an electropositive element:

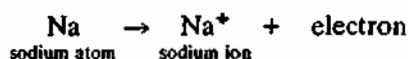

Chlorine atoms have the electronic configuration  $1s^2 2s^2 2p^6 3s^2 3p^5$ . They are only one electron short of the stable noble gas configuration of argon  $1s^2 2s^2 2p^6 3s^2 3p^6$ , and when chlorine atoms react, they gain an electron. Thus chlorine is an electronegative element.

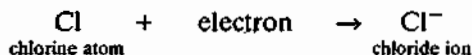

Through gaining an electron, an electrically neutral chlorine atom becomes a chloride ion with a net charge of -1.

When sodium and chlorine react together, the outer electron of the sodium atoms is transferred to the chlorine atoms to produce sodium ions  $\text{Na}^+$  and chloride ions  $\text{Cl}^-$ . Electrostatic attraction between the positive and negative ions holds the ions together in a crystal lattice. The process is energetically favourable as both sorts of atoms attain the stable noble gas configuration, and sodium chloride  $\text{Na}^+\text{Cl}^-$  is formed readily. This may be illustrated diagrammatically in a Lewis diagram showing the outer electrons as dots:

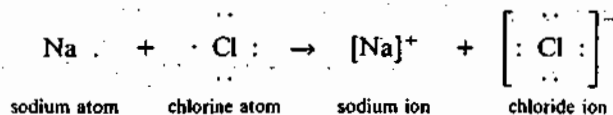

The formation of calcium chloride  $\text{CaCl}_2$  may be considered in a similar way. Ca atoms have two electrons in their outer shell. Ca is an electropositive element, so each Ca atom loses two electrons to two Cl atoms, forming a calcium ion  $\text{Ca}^{2+}$  and two chloride ions  $\text{Cl}^-$ . Showing the outer electrons only, this may be represented as follows:

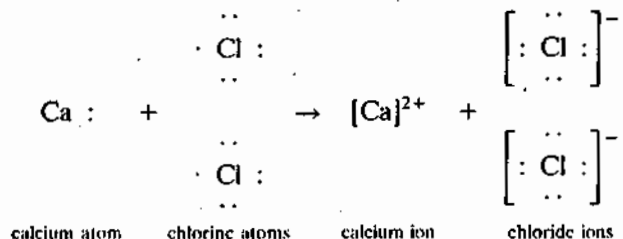

### Covalent bonds

When two electronegative atoms react together, both atoms have a tendency to gain electrons, but neither atom has any tendency to lose electrons. In such cases the atoms share electrons so as to attain a noble gas configuration.

First consider diagrammatically how two chlorine atoms Cl react to form a chlorine molecule  $\text{Cl}_2$  (only the outer electrons are shown in the following diagrams):

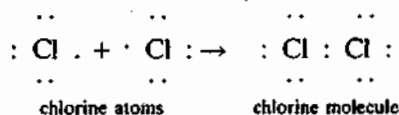

Each chlorine atom gives a share of one of its electrons to the other atom. A pair of electrons is shared equally between both atoms, and each atom now has eight electrons in its outer shell (a stable octet) – the noble gas structure of argon. In this electron dot picture (Lewis structure), the shared electron pair is shown as two dots between the atoms  $\text{Cl} : \text{Cl}$ . In the valence bond representation, these dots are replaced by a line, which represents a bond  $\text{Cl} - \text{Cl}$ .

In a similar way a molecule of tetrachloromethane  $\text{CCl}_4$  is made up of one carbon and four chlorine atoms:

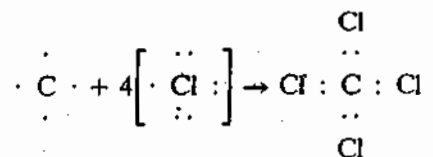

The carbon atom is four electrons short of the noble gas structure, so it forms four bonds, and the chlorine atoms are one electron short, so they each form one bond. By sharing electrons in this way, both the carbon and all four chlorine atoms attain a noble gas structure. It must be emphasized

that although it is possible to build up molecules in this way in order to understand their electronic structures, it does not follow that the atoms will react together directly. In this case, carbon and chlorine do not react directly, and tetrachloromethane is made by indirect reactions.

A molecule of ammonia  $\text{NH}_3$  is made up of one nitrogen and three hydrogen atoms:

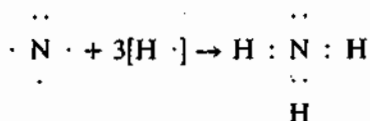

The nitrogen atom is three electrons short of a noble gas structure, and the hydrogen atoms are one electron short of a noble gas structure. Nitrogen forms three bonds, and the hydrogen atoms one bond each, so all four atoms attain a stable configuration. One pair of electrons on the N atom is not involved in bond formation, and this is called a *lone pair* of electrons.

Other examples of covalent bonds include water (with two covalent bonds and two lone pairs of electrons), and hydrogen fluoride (one covalent bond and three lone pairs):

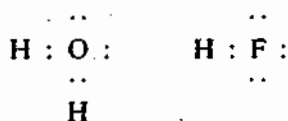

### Oxidation numbers

The oxidation number of an element in a covalent compound is calculated by assigning shared electrons to the more electronegative element, and then counting the theoretical charge left on each atom. (Electronegativity is described in Chapter 6.) An alternative approach is to break up (theoretically) the molecule by removing all the atoms as ions, and counting the charge left on the central atom. It must be emphasized that molecules are not really broken, nor electrons really moved. For example, in  $\text{H}_2\text{O}$ , removal of two  $\text{H}^+$  leaves a charge of  $-2$  on the oxygen atom, so the oxidation state of O in  $\text{H}_2\text{O}$  is  $(-II)$ . Similarly in  $\text{H}_2\text{S}$  the oxidation state of S is  $(-II)$ ; in  $\text{F}_2\text{O}$  the oxidation state of O is  $(+II)$ ; in  $\text{SF}_4$  the oxidation state of S is  $(+IV)$ ; whilst in  $\text{SF}_6$  the oxidation state of S is  $(+VI)$ . The concept of oxidation numbers works equally well with ionic compounds, and in  $\text{CrCl}_3$  the Cr atom has an oxidation state of  $(+III)$  and it forms  $\text{Cr}^{3+}$  ions. Similarly in  $\text{CrCl}_2$ , Cr has the oxidation state  $(+II)$ , and exists as  $\text{Cr}^{2+}$  ions.

### Coordinate bonds

A covalent bond results from the sharing of a pair of electrons between two atoms, where each atom contributes one electron to the bond. It is also

possible to have an electron pair bond where both electrons originate from one atom and none from the other. Such bonds are called coordinate bonds or dative bonds. Since, in coordinate bonds, two electrons are shared by two atoms, they differ from normal covalent bonds only in the way they are formed, and once formed they are identical to normal covalent bonds.

Even though the ammonia molecule has a stable electron configuration, it can react with a hydrogen ion  $H^+$  by donating a share in the lone pair of electrons, forming the ammonium ion  $NH_4^+$ :

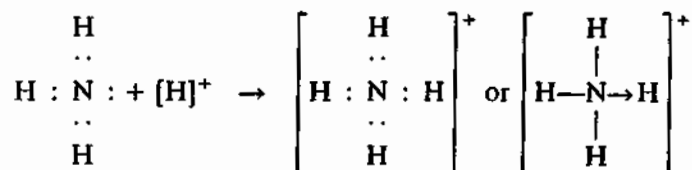

Covalent bonds are usually shown as straight lines joining the two atoms, and coordinate bonds as arrows indicating which atom is donating the electrons. Similarly ammonia may donate its lone pair to boron trifluoride, and by this means the boron atom attains a share in eight electrons:

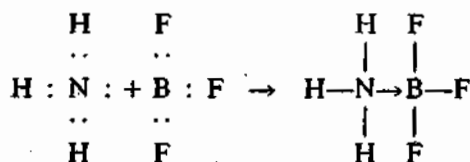

In a similar way, a molecule of  $BF_3$  can form a coordinate bond by accepting a share in a lone pair from a  $F^-$  ion.

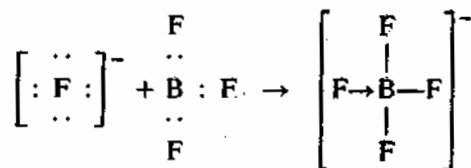

There are many other examples, including:

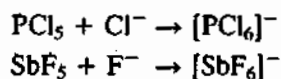

### Double and triple bonds

Sometimes more than two electrons are shared between a pair of atoms. If four electrons are shared, then there are two bonds, and this arrangement is called a double bond. If six electrons are shared then there are three bonds, and this is called a triple bond:

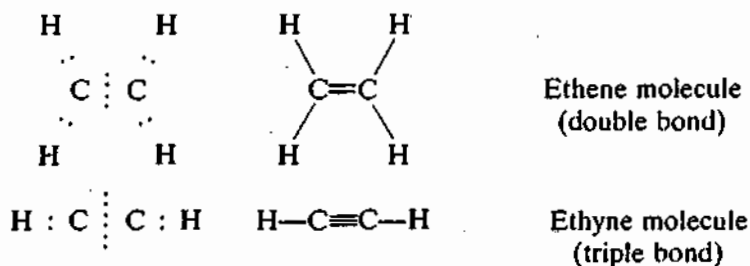

### Metallic bonds and metallic structures

Metals are made up of positive ions packed together, usually in one of the three following arrangements:

1. Cubic close-packed (also called face-centred cubic).
2. Hexagonal close-packed.
3. Body-centred cubic.

Negatively charged electrons hold the ions together. The number of positive and negative charges are exactly balanced, as the electrons originated from the neutral metal atoms. The outstanding feature of metals is their extremely high electrical conductivity and thermal conductivity, both of which are because of the mobility of these electrons through the lattice.

The arrangements of atoms in the three common metallic structures are shown in Figure 2.2. Two of these arrangements (cubic close-packed and hexagonal close-packed) are based on the closest packing of spheres. The metal ions are assumed to be spherical, and are packed together to fill the space most effectively, as shown in Figure 2.3a. Each sphere touches six other spheres within this one layer.

A second layer of spheres is arranged on top of the first layer, the protruding parts of the second layer fitting into the hollows in the first layer as shown in Figure 2.4a. A sphere in the first layer touches three spheres in the layer above it, and similarly touches three spheres in the layer below it, plus six spheres in its own layer, making a total of 12. The coordination number, or number of atoms or ions in contact with a given atom, is therefore 12 for a close-packed arrangement. With a close-packed arrangement, the spheres occupy 74% of the total space.

When adding a third layer of spheres, two different arrangements are possible, each preserving the close-packed arrangement.

If the first sphere of the third layer is placed in the depression X shown in Figure 2.4a, then this sphere is exactly above a sphere in the first layer. It follows that every sphere in the third layer is exactly above a sphere in the first layer as shown in Figure 2.2a. If the first layer is represented by A, and the second layer by B, the repeating pattern of close-packed sheets is ABABAB. . . . This structure has hexagonal symmetry, and it is therefore said to be hexagonal close-packed.

Alternatively, the first sphere of the third layer may be placed in a

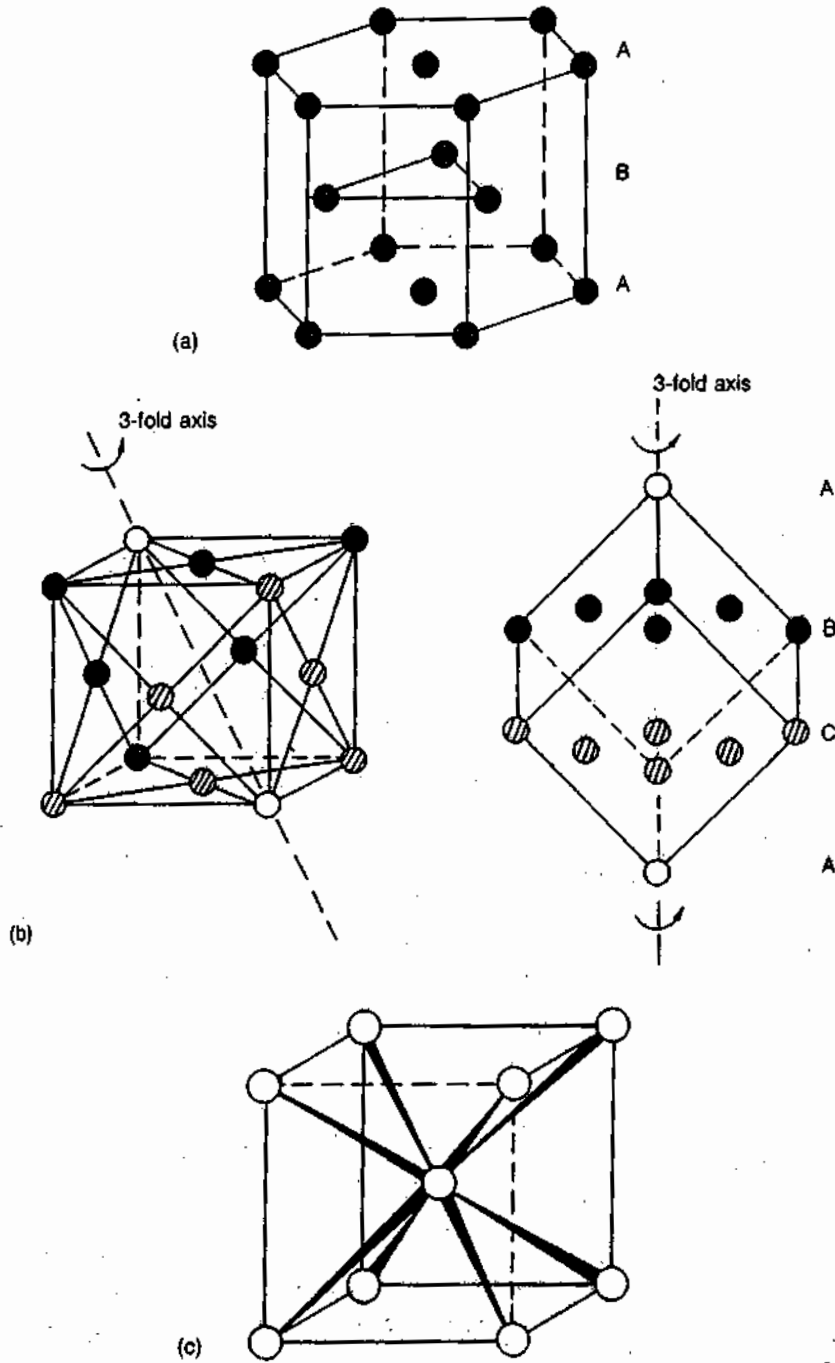

Figure 2.2 The three metallic structures. (a) Hexagonal close-packed structure showing the repeat pattern of layers ABABAB... and the 12 neighbours surrounding each sphere. (b) Cubic close-packed structure (coordination number is also 12) showing repeat pattern of layers ABCABC. (c) Body-centred cubic structure showing the 8 neighbours surrounding each sphere.

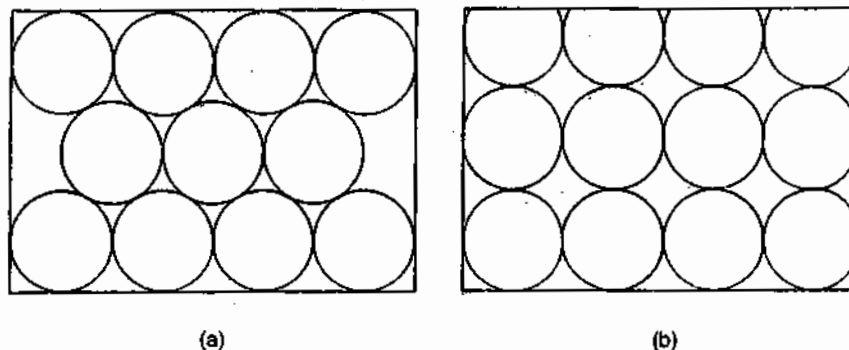

Figure 2.3 Possible ways of packing equal spheres in two dimensions. (a) Close-packed (fills 74% of space). (b) Body-centred cubic (fills 68% of space).

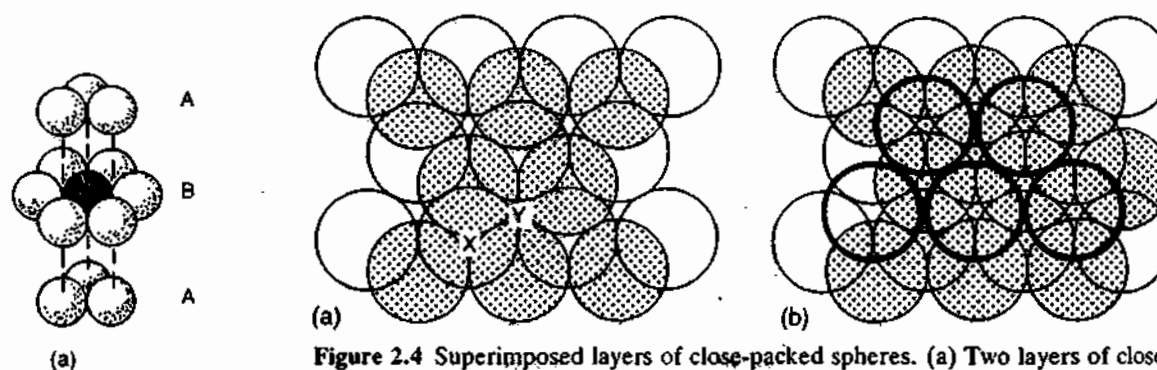

Figure 2.4 Superimposed layers of close-packed spheres. (a) Two layers of close-packed spheres (second layer is shaded). (b) Three layers of close-packed spheres (second layer shaded, third layer bold circles). Note that the third layer is not above the first layer, hence this is an ABCABC... (cubic close-packed) arrangement.

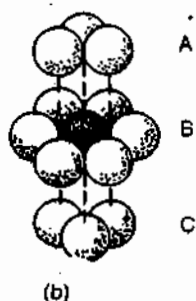

Figure 2.5 Arrangement of 12 neighbours in hexagonal close-packed (a) and cubic close-packed (b) structures. (Note that the top and bottom layers are the same, the cubic close-packed structure is 60° relative to the hexagonal close-packed.) (a) Hexagonal close-packed. (b) Cubic close-packed.

depression such as Y in Figure 2.4a. The sphere is not exactly above a sphere in the first layer, and it follows that all the spheres in the third layer are not exactly above spheres in the first layer (Figure 2.4b). If the three layers are represented by A, B and C, then the repeating pattern of sheets is ABCABCABC... (Figure 2.2b). This structure has cubic symmetry and is said to be cubic close-packed. An alternative name for this structure is face-centred cubic. The difference between hexagonal and cubic close packing is illustrated in Figure 2.5.

Random forms of close packing such as ABABC or ACBACB are possible, but occur only rarely. Hexagonal ABABAB and cubic ABCABC close packing are common.

The third common metallic structure is called body-centred cubic (Figure 2.2c). The spheres are packed in sheets as shown in Figure 2.3b. The second layer occupies the hollows in this first sheet. The third layer occupies hollows in the second layer, and the third layer is immediately above the first layer. This form of packing is less efficient at filling the space



than closest packing (compare Figures 2.3a and b). In a body-centred cubic structure the spheres occupy 68% of the total space and have a coordination number of 8, compared with close-packed structures where 74% of the space is occupied and the coordination number is 12. Metallic structures always have high coordination numbers.

The theories of bonding in metals and alloys are described in Chapter 5.

Metallic bonding is found not only in metals and alloys, but also in several other types of compound:

1. Interstitial borides, carbides, nitrides and hydrides formed by the transition elements (and by some of the lanthanides too). Some low oxidation states of transition metal halides also belong to this group, where the compounds show electrical conductivity, and are thought to contain free electrons in conduction bands.
2. Metal cluster compounds of the transition metals, and cluster compounds of boron, where the covalent bonding is delocalized over several atoms, and is equivalent to a restricted form of metallic bonding.
3. A group of compounds including the metal carbonyls which contain a metal-metal bond. The cluster compounds, and the compounds with metal-metal bonds, may help to explain the role of metals as catalysts.

### Melting points

Ionic compounds are typically solids and usually have high melting and boiling points. In contrast covalent compounds are typically gases, liquids or low melting solids. These differences occur because of differences in bonding and structure.

Ionic compounds are made up of positive and negative ions arranged in a regular way in a lattice. The attraction between ions is electrostatic, and is non-directional, extending equally in all directions. Melting the compound involves breaking the lattice. This requires considerable energy, and so the melting point and boiling point are usually high, and the compounds are very hard.

Compounds with covalent bonds are usually made up of discrete molecules. The bonds are directional, and strong covalent bonding forces hold the atoms together to make a molecule. In the solid, molecules are held together by weak van der Waals forces. To melt or boil the compound we only need supply the small amount of energy needed to break the van der Waals forces. Hence covalently bonded compounds are often gases, liquids or soft solids with low melting points.

In a few cases such as diamond, or silica  $\text{SiO}_2$ , the structures are covalent giant lattices instead of discrete molecules. In these cases there is a three-dimensional lattice, with strong covalent bonds in all directions. It requires a large amount of energy to break this lattice, and so diamond, silica and other materials with giant three-dimensional lattices are very hard and have high melting points.

### Conductivity

Ionic compounds conduct electricity *when the compound is melted, or in solution*. Conduction is achieved by the ions migrating towards the electrodes under the influence of an electric potential. If an electric current is passed through a solution of sodium chloride,  $\text{Na}^+$  ions are attracted to the negatively charged electrode (cathode), where they gain an electron and form sodium atoms. The  $\text{Cl}^-$  ions are attracted to the positive electrode (anode), where they lose an electron and become chlorine atoms. This process is called electrolysis. The changes amount to the transfer of electrons from cathode to anode, but *conduction occurs by an ionic mechanism involving the migration of both positive and negative ions in opposite directions*.

In the solid state, the ions are trapped in fixed places in the crystal lattice, and as they cannot migrate, they cannot conduct electricity in this way. It is, however, wrong to say that ionic solids do not conduct electricity without qualifying the statement. The crystal may conduct electricity *to a very small extent* by semiconduction if the crystal contains some defects. Suppose that a lattice site is unoccupied, and there is a 'hole' where an ion is missing. An ion may migrate from its lattice site to the vacant site, and in so doing it makes a 'hole' somewhere else. The new 'hole' is filled by another ion, and so on, so eventually the hole migrates across the crystal, and a charge is carried in the other direction. Plainly the amount of current carried by this mechanism is extremely small, but semiconductors are of great importance in modern electronic devices.

Metals conduct electricity better than any other material, but the mechanism is by the movement of electrons instead of ions.

Covalent compounds contain neither ions (as in ionic compounds) nor mobile electrons (as in metals), so they are unable to conduct electricity in either the solid, liquid or gaseous state. Covalent compounds are therefore insulators.

### Solubility

If they dissolve at all, ionic compounds are usually soluble in polar solvents. These are solvents of high dielectric constant such as water, or the mineral acids. Covalent compounds are not normally soluble in these solvents but if they dissolve at all they are soluble in non-polar (organic) solvents of low dielectric constant, such as benzene and tetrachloromethane. The general rule is sometimes stated that 'like dissolves like', and so ionic compounds usually dissolve in ionic solvents, and covalent compounds usually dissolve in covalent solvents.

### Speed of reactions

Ionic compounds usually react very rapidly, whilst covalent compounds usually react slowly. For ionic reactions to occur, the reacting species are

ions, and as these already exist, they have only to collide with the other type of ion. For example, when testing a solution for chloride ions (by adding silver nitrate solution), precipitation of AgCl is very rapid.

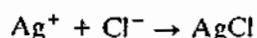

Reactions of covalent compounds usually involve breaking a bond and then substituting or adding another group. Energy is required to break the bond. This is called the activation energy, and it often makes reactions slow. Collisions between the reactant molecules will only cause reaction if they have enough energy. For example, reduction of preparative amounts of nitrobenzene to aniline takes several hours. Similarly the reaction of  $\text{H}_2$  and  $\text{Cl}_2$  is typically slow except in direct sunlight when the mixture may explode!

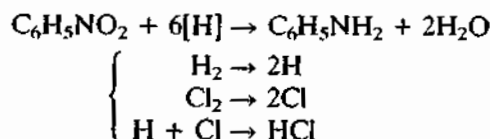

It is important to realize that bonds are not necessarily 100% covalent or 100% ionic, and that bonds of intermediate character exist. If a molecule is made up of two identical atoms, both atoms have the same electronegativity, and so have an equal tendency to gain electrons. (See Chapter 6.) In such a molecule the electron pair forming the bond is equally shared by both atoms. This constitutes a 100% covalent bond, and is sometimes called a *non-polar covalent bond*.

More commonly molecules are formed between different types of atoms, and the electronegativity of the two atoms differs. Consider for example the molecules ClF and HF. Fluorine is the most electronegative atom, and it attracts electrons more strongly than any other element when covalently bonded. The bonding electrons spend more time round the F than round the other atom, so the F atom has a very small negative charge  $\delta^-$  and the atom (Cl or H) has a small positive charge  $\delta^+$ .

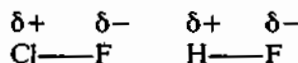

Though these bonds are largely covalent, they possess a small amount of ionic character, and are sometimes called *polar covalent bonds*. In such molecules, a positive charge, and an equal negative charge, are separated by a distance. This produces a permanent dipole moment in the molecule.

The dipole moment measures the tendency of the molecule to turn and line up its charges when placed in an electric field. Polar molecules have a high dielectric constant, and non-polar molecules have a low dielectric constant. The dielectric constant is the ratio of the capacitance of a condenser with the material between the plates, to the capacitance of the same condenser with a vacuum between them. By measuring the capacitance with the substance between the plates and then with a vacuum, we

can obtain the dielectric constant. Its size indicates whether the material is polar or non-polar.

Ionic, covalent and metallic bonds are considered in more detail in the following chapters.

# The ionic bond

# 3

## STRUCTURES OF IONIC SOLIDS

Ionic compounds include salts, oxides, hydroxides, sulphides, and the majority of inorganic compounds. Ionic solids are held together by the electrostatic attraction between the positive and negative ions. Plainly there will be repulsion if ions of the same charge are adjacent, and attraction will occur when positive ions are surrounded by negative ions, and vice versa. The attractive force will be a maximum when each ion is surrounded by the greatest possible number of oppositely charged ions. The number of ions surrounding any particular ion is called the coordination number. Positive and negative ions will both have the same coordination number when there are equal numbers of both types of ions, as in NaCl, but the coordination numbers for positive and negative ions are different when there are different numbers of the ions, as in  $\text{CaCl}_2$ .

## RADIUS RATIO RULES

The structures of many ionic solids can be accounted for by considering the relative sizes of the positive and negative ions, and their relative numbers. Simple geometric calculations allow us to work out how many ions of a given size can be in contact with a smaller ion. Thus we can predict the coordination number from the relative sizes of the ions.

When the coordination number is three in an ionic compound AX, three  $\text{X}^-$  ions are in contact with one  $\text{A}^+$  ion (Figure 3.1a). A limiting case arises (Figure 3.1b) when the  $\text{X}^-$  ions are also in contact with one another. By simple geometry this gives the ratio (radius  $\text{A}^+$ /radius  $\text{X}^-$ ) = 0.155. This is the lower limit for a coordination number of 3. If the radius ratio is less than 0.155 then the positive ion is not in contact with the negative ions, and it 'rattles' in the hole, and the structure is unstable (Figure 3.1c). If the radius ratio is greater than 0.155 then it is possible to fit three  $\text{X}^-$  ions round each  $\text{A}^+$  ion. As the difference in the size of the two ions increases, the radius ratio also increases, and at some point (when the ratio exceeds 0.225), it becomes possible to fit four ions round one, and so on for six ions round one, and eight ions round one. Coordination numbers of 3, 4, 6 and

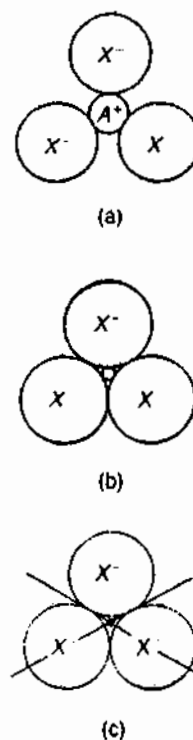

Figure 3.1 Sizes of ions for coordination number 3.

Table 3.1 Limiting radius ratios and structures

Limiting radius ratio $r^+/r^-$	Coordination number	Shape
<0.155	2	Linear
0.155 → 0.225	3	Planar triangle
0.225 → 0.414	4	Tetrahedral
0.414 → 0.732	4	Square planar
0.414 → 0.732	6	Octahedral
0.732 → 0.999	8	Body-centred cubic

8 are common, and the appropriate limiting radius ratios can be worked out by simple geometry, and are shown in Table 3.1.

If the ionic radii are known, the radius ratio can be calculated and hence the coordination number and shape may be predicted. This simple concept predicts the correct structure in many cases.

#### CALCULATION OF SOME LIMITING RADIUS RATIO VALUES

This section may be skipped except by those interested in the origin of the limiting radius ratio values.

##### Coordination number 3 (planar triangle)

Figure 3.2a shows the smaller positive ion of radius  $r^+$  in contact with three larger negative ions of radius  $r^-$ . Plainly  $AB = BC = AC = 2r^-$ ,  $BE = r^-$ ,  $BD = r^+ + r^-$ . Further, the angle  $A-B-C$  is  $60^\circ$ , and the angle  $D-B-E$  is  $30^\circ$ . By trigonometry

$$\cos 30^\circ = BE/BD$$

$$BD = BE/\cos 30^\circ$$

$$r^+ + r^- = r^-/\cos 30^\circ = r^-/0.866 = r^- \times 1.155$$

$$r^+ = (1.155r^-) - r^- = 0.155r^-$$

hence  $r^+/r^- = 0.155$

##### Coordination number 4 (tetrahedral)

Figure 3.2b shows a tetrahedral arrangement inscribed in a cube with sides of length  $d$ . The diagonal on the bottom face  $XX$  is  $2 \times r^-$ . By Pythagoras, on the triangle  $VXY$ ,

$$XY^2 = VX^2 + VY^2$$

$$XY^2 = d^2 + d^2 = 2d^2$$

hence  $XY = d\sqrt{2}$

and  $2r^- = d\sqrt{2}$

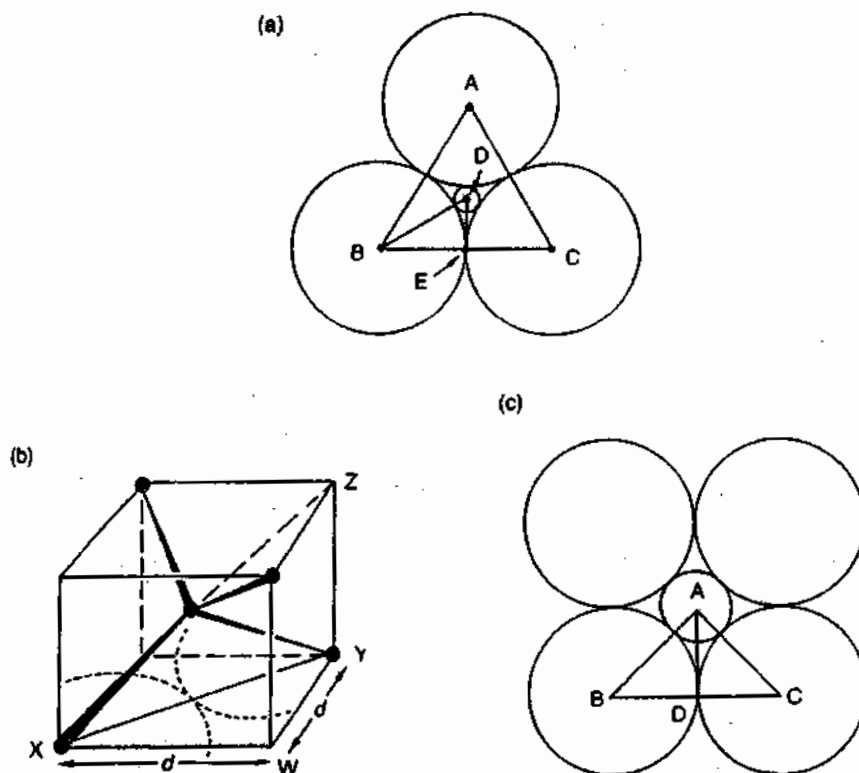

Figure 3.2 Limiting radius ratios for coordination numbers 3, 4 and 6. (a) Cross-section through a planar triangle site; (b) tetrahedron inscribed in a cube; and (c) cross-section through an octahedral site.

In the triangle XZY, by Pythagoras

$$\begin{aligned} XZ^2 &= XY^2 + YZ^2 \\ &= (d\sqrt{2})^2 + d^2 = 3d^2 \end{aligned}$$

so

$$XZ = d\sqrt{3}$$

However

$$XZ = 2r^+ + 2r^-$$

so

$$2r^+ + 2r^- = d\sqrt{3}$$

and

$$\begin{aligned} 2r^+ &= d\sqrt{3} - 2r^- \\ &= d\sqrt{3} - d\sqrt{2} \end{aligned}$$

$$r^+/r^- = \frac{1}{2}(d\sqrt{3} - d\sqrt{2}) / \frac{1}{2}d\sqrt{2} = \sqrt{3/2} - 1 = 1.225 - 1 = 0.225$$

Coordination number 6 (octahedral)

A cross-section through an octahedral site is shown in Figure 3.2c, and the smaller positive ion (of radius  $r^+$ ) touches the six larger negative ions (of radius  $r^-$ ). (Note that only four negative ions are shown in this section, and

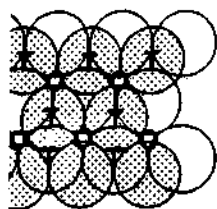

one is above and another one below the plane of the paper.) It is obvious that  $AB = r^+ + r^-$ , and that  $BD = AD = r^-$ . By Pythagoras

$$AB^2 = AD^2 + BD^2$$

i.e.

$$(r^+ + r^-)^2 = (r^-)^2 + (r^-)^2 = 2(r^-)^2$$

hence

$$r^+ + r^- = \sqrt{2(r^-)^2} = 1.414r^-$$

$$r^+ = 0.414r^-$$

hence

$$r^+/r^- = 0.414$$

### CLOSE PACKING

Many common crystal structures are related to, and may be described in terms of, hexagonal or cubic close-packed arrangements. Because of their shape, spheres cannot fill space completely. In a close-packed arrangement of spheres, 74% of the space is filled. Thus 26% of the space is unoccupied, and may be regarded as holes in the crystal lattice. Two different types of hole occur. Some are bounded by four spheres and are called tetrahedral holes (marked T in Figure 3.3), and others are bounded by six spheres and are called octahedral holes (marked O in Figure 3.3). For every sphere in

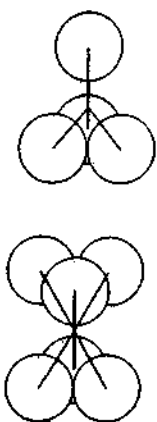

Tetrahedral and octahedral holes: (a) tetrahedral sites in a close-packed arrangement; (b) tetrahedral and octahedral sites.

Table 3.2 Some structures based on close packing

Formula	Type of cp	Tetrahedral	Octahedral	Coordination No.	
				A	X
AX	NaCl	ccp	none	all	6 : 6
	NiAs	hcp	none	all	6 : 6
	ZnS zinc blende	ccp	$\frac{1}{2}$	none	4 : 4
	ZnS wurtzite	hcp	$\frac{1}{2}$	none	4 : 4
AX <sub>2</sub>	F <sub>2</sub> Ca* fluorite	ccp*	all	none	8 : 4
	CdI <sub>2</sub>	hcp	none	$\frac{1}{2}$	6 : 3
	CdCl <sub>2</sub>	ccp	none	$\frac{1}{2}$	6 : 3
	$\beta$ -ZnCl <sub>2</sub>	hcp	$\frac{1}{4}$	none	4 : 2
	HgI <sub>2</sub>	ccp	$\frac{1}{4}$	none	4 : 2
MX <sub>3</sub>	BiI <sub>3</sub>	hcp	none	$\frac{1}{3}$	6 : 2
	CrCl <sub>3</sub>	ccp	none	$\frac{1}{3}$	6 : 2
MX <sub>4</sub>	SnI <sub>4</sub>	hcp	$\frac{1}{8}$	none	4 : 1
MX <sub>6</sub>	$\alpha$ -WCl <sub>6</sub> and UCl <sub>6</sub>	ccp	none	$\frac{1}{6}$	6 : 1
M <sub>2</sub> X <sub>3</sub>	$\alpha$ -Al <sub>2</sub> O <sub>3</sub> corundum	hcp	none	$\frac{2}{3}$	6 : 4

\* The metal ions adopt a face-centred cubic arrangement, which is exactly like cubic close packing except that the ions do not touch. (Note it is the M<sup>+</sup> ions that are almost close packed, not the negative ions as with the other examples.)



the close-packed arrangement there is one octahedral hole and two tetrahedral holes. The octahedral holes are larger than the tetrahedral holes.

An ionic structure is composed of oppositely charged ions. If the larger ions are close packed, then the smaller ions may occupy either the octahedral holes or the tetrahedral holes depending on their size. Normally the type of hole occupied can be determined from the radius ratio. An ion occupying a tetrahedral hole has a coordination number of 4, whilst one occupying an octahedral hole has a coordination number of 6. In some compounds the relative sizes of the ions are such that the smaller ions are too large to fit in the holes, and they force the larger ions out of contact with each other so that they are no longer close packed. Despite this, the relative positions of the ions remain unchanged, and it is convenient to retain the description in terms of close packing.

### CLASSIFICATION OF IONIC STRUCTURES

It is convenient to divide ionic compounds into groups AX, AX<sub>2</sub>, AX<sub>3</sub> depending on the relative numbers of positive and negative ions.

### IONIC COMPOUNDS OF THE TYPE AX (ZnS, NaCl, CsCl)

Three structural arrangements commonly found are the zinc sulphide, sodium chloride and caesium chloride structures.

#### Structures of zinc sulphide

In zinc sulphide, ZnS, the radius ratio of 0.40 suggests a tetrahedral arrangement. Each Zn<sup>2+</sup> ion is tetrahedrally surrounded by four S<sup>2-</sup> ions and each S<sup>2-</sup> ion is tetrahedrally surrounded by four Zn<sup>2+</sup> ions. The coordination number of both ions is 4, so this is called a 4:4 arrangement. Two different forms of zinc sulphide exist, zinc blende and wurtzite (Figure 3.4). Both are 4:4 structures.

These two structures may be considered as close-packed arrangements of S<sup>2-</sup> ions. Zinc blende is related to a cubic close-packed structure whilst wurtzite is related to a hexagonal close-packed structure. In both structures the Zn<sup>2+</sup> ions occupy tetrahedral holes in the lattice. Since there are twice as many tetrahedral holes as there are S<sup>2-</sup> ions, it follows that to obtain a formula ZnS only half of the tetrahedral holes are occupied by Zn<sup>2+</sup> ions (that is every alternate tetrahedral site is unoccupied).

#### Sodium chloride structure

For sodium chloride, NaCl, the radius ratio is 0.52 and this suggests an octahedral arrangement. Each Na<sup>+</sup> ion is surrounded by six Cl<sup>-</sup> ions at the corners of a regular octahedron and similarly each Cl<sup>-</sup> ion is surrounded by six Na<sup>+</sup> ions (Figure 3.5). The coordination is thus 6:6. This structure

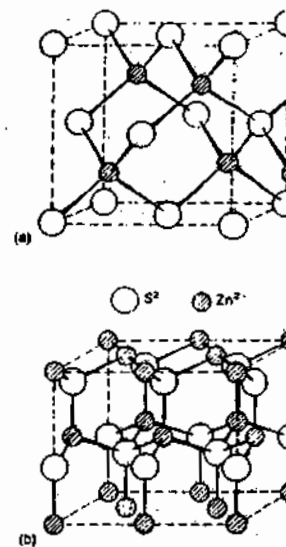
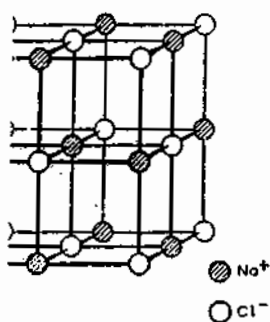

Figure 3.4 Structures of ZnS: (a) zinc blende and (b) wurtzite. (Reproduced with permission from Wells, A.F., *Structural Inorganic Chemistry*, 5th ed., Oxford University Press, Oxford, 1984.)



3.5 Rock salt (NaCl) structure. (Reproduced by permission of Wells, A.F., *Inorganic Chemistry*, Oxford University Press, 1984.)

may be regarded as a cubic close-packed array of  $\text{Cl}^-$  ions, with  $\text{Na}^+$  ions occupying all the octahedral holes.

#### Caesium chloride structure

In caesium chloride,  $\text{CsCl}$ , the radius ratio is 0.93. This indicates a body-centred cubic type of arrangement, where each  $\text{Cs}^+$  ion is surrounded by eight  $\text{Cl}^-$  ions, and vice versa (Figure 3.6). The coordination is thus 8:8. Note that this structure is not close packed, and is not strictly body-centred cubic.

In a body-centred cubic arrangement, the atom at the centre of the cube is identical to those at the corners. This structure is found in metals, but in  $\text{CsCl}$  if the ions at the corners are  $\text{Cl}^-$  then there will be a  $\text{Cs}^+$  ion at the body-centred position, so it is not strictly body-centred cubic. The caesium chloride structure should be described as a *body-centred cubic type of arrangement* and not *body-centred cubic*.

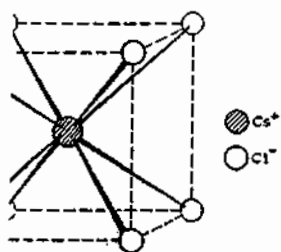

3.6 Caesium chloride structure. (Reproduced by permission of Wells, A.F., *Inorganic Chemistry*, Oxford University Press, 1984.)

#### IONIC COMPOUNDS OF THE TYPE $\text{AX}_2$ ( $\text{CaF}_2$ , $\text{TiO}_2$ , $\text{SiO}_2$ )

The two most common structures are fluorite,  $\text{CaF}_2$  (Figure 3.7), and rutile,  $\text{TiO}_2$  (Figure 3.8), and many difluorides and dioxides have one of these structures. Another fairly common structure is one form of  $\text{SiO}_2$  called  $\beta$ -cristobalite (Figure 3.9). These are true ionic structures. Layer structures are formed instead if the bonding becomes appreciably covalent.

#### Calcium fluoride (fluorite) structure

In fluorite, each  $\text{Ca}^{2+}$  ion is surrounded by eight  $\text{F}^-$  ions, giving a body-centred cubic arrangement of  $\text{F}^-$  round  $\text{Ca}^{2+}$ . Since there are twice as many  $\text{F}^-$  ions as  $\text{Ca}^{2+}$  ions, the coordination number of both ions is different, and four  $\text{Ca}^{2+}$  ions are tetrahedrally arranged around each  $\text{F}^-$  ion. The coordination numbers are therefore 8 and 4, so this is called an 8:4 arrangement. The fluorite structure is found when the radius ratio is 0.73 or above.

An alternative description of the structure is that the  $\text{Ca}^{2+}$  ions form a face-centred cubic arrangement. The  $\text{Ca}^{2+}$  ions are too small to touch each other, so the structure is not close packed. However, the structure is related to a close-packed arrangement, since the  $\text{Ca}^{2+}$  occupy the same relative positions as for a cubic close-packed structure, and the  $\text{F}^-$  ions occupy all the tetrahedral holes.

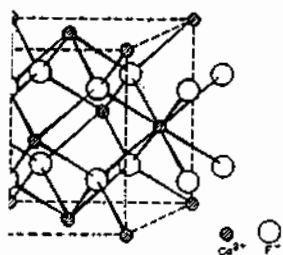

3.7 Fluorite ( $\text{CaF}_2$ ) structure. (Reproduced by permission of Wells, A.F., *Inorganic Chemistry*, Oxford University Press, 1984.)

#### Rutile structure

$\text{TiO}_2$  exists in three forms called anatase, brookite and rutile. The rutile structure is found in many crystals where the radius ratio is between 0.4 and 0.73. This suggests a coordination number of 6 for one ion, and from the formula it follows that the coordination number of the other ion must

be 3. This is a 6:3 structure. Each  $\text{Ti}^{4+}$  is octahedrally surrounded by six  $\text{O}^{2-}$  ions and each  $\text{O}^{2-}$  ion has three  $\text{Ti}^{4+}$  ions round it in a plane triangular arrangement.

The rutile structure is not close packed. The unit cell, i.e. the repeating unit of this structure, is not a cube, since one of the axes is 30% shorter than the other two. It is convenient to describe it as a considerably distorted cube (though the distortion is rather large). The structure may then be described as a considerably distorted body-centred cubic lattice of  $\text{Ti}^{4+}$  ions. Each  $\text{Ti}^{4+}$  ion is surrounded octahedrally by six  $\text{O}^{2-}$  ions, and the  $\text{O}^{2-}$  are in positions of threefold coordination, that is each  $\text{O}^{2-}$  is surrounded by three  $\text{Ti}^{4+}$  ions at the corners of an equilateral triangle. Three-coordination is not common in solids. There are no examples of three-coordination in compounds of the type AX, but there is another example in the compounds of type  $\text{AX}_2$ , that is  $\text{CdI}_2$ , though in this case the shape is not an equilateral triangle. The structure of  $\text{CaCl}_2$  is also a 6:3 structure, and is similar to  $\text{CdI}_2$ . These are described later.

There are only a few cases where the radius ratio is below 0.41. Examples include silica  $\text{SiO}_2$  and beryllium fluoride  $\text{BeF}_2$ . These have coordination numbers of 4 and 2, but radius ratio predictions are uncertain since they are appreciably covalent.

#### $\beta$ -cristobalite (silica) structure

Silica  $\text{SiO}_2$  exists in six different crystalline forms as quartz, cristobalite and tridymite, each with an  $\alpha$  and  $\beta$  form.  $\beta$ -cristobalite is related to zinc blende, with two interpenetrating close-packed lattices, one lattice arising from Si occupying the  $\text{S}^{2-}$  positions, and the other lattice from Si occupying the  $\text{Zn}^{2+}$  positions (i.e. the tetrahedral holes in the first lattice). The oxygen atoms lie midway between the Si atoms, but are shifted slightly off the line joining the Si atoms, so the bond angle  $\text{Si}-\text{O}-\text{Si}$  is not  $180^\circ$ . The radius ratio predicts a coordination number of 4, and this is a 4:2 structure.

#### LAYER STRUCTURES ( $\text{CdI}_2$ , $\text{CdCl}_2$ , $[\text{NiAs}]$ )

##### Cadmium iodide structure

Many  $\text{AX}_2$  compounds are not sufficiently ionic to form the perfectly regular ionic structures described. Many chlorides, bromides, iodides and sulphides crystallize into structures which are very different from those described. Cadmium fluoride  $\text{CdF}_2$  forms an ionic lattice with the  $\text{CaF}_2$  structure, but in marked contrast cadmium iodide  $\text{CdI}_2$  is much less ionic, and does not form the fluorite structure. The radius ratio for  $\text{CdI}_2$  is 0.45, and this indicates a coordination number of 6 for cadmium. The structure is made up of electrically neutral layers of  $\text{Cd}^{2+}$  ions with layers of  $\text{I}^-$  ions on either side – rather like a sandwich where a layer of  $\text{Cd}^{2+}$  corresponds to the meat in the middle, and layers of  $\text{I}^-$  correspond to the bread on either

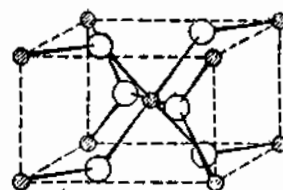

Figure 3.8 Rutile ( $\text{TiO}_2$ ) structure.

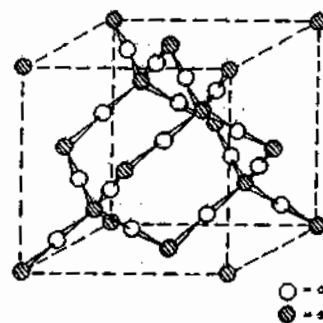

Figure 3.9  $\beta$ -cristobalite structure.

side. This is called a layer structure, and it is not a completely regular ionic structure. With a sandwich, bread is separated from bread by the meat, but in a pile of sandwiches, bread from one sandwich touches bread from the next sandwich. Similarly, in  $\text{CdI}_2$  two sheets of  $\text{I}^-$  ions are separated by  $\text{Cd}^{2+}$  within a 'sandwich', but between one 'sandwich' and the next, two  $\text{I}^-$  layers are in contact. Whilst there is strong electrostatic bonding between  $\text{Cd}^{2+}$  and  $\text{I}^-$  layers, there are only weak van der Waals forces holding the adjacent layers of  $\text{I}^-$  together. The packing of layers in the crystal structure is not completely regular, and the solid is flaky, and it cleaves into two parallel sheets quite easily. This structure is adopted by many transition metal diiodides (Ti, V, Mn, Fe, Co, Zn, Cd) and by some main group diiodides and dibromides (Mg, Ca, Ge and Pb). Many hydroxides have similar layer structures ( $\text{Mg}(\text{OH})_2$ ,  $\text{Ca}(\text{OH})_2$ ,  $\text{Fe}(\text{OH})_2$ ,  $\text{Co}(\text{OH})_2$ ,  $\text{Ni}(\text{OH})_2$ , and  $\text{Cd}(\text{OH})_2$ ).

In cadmium iodide, the third layer of  $\text{I}^-$  ions is directly above the first layer, so the repeating pattern is ABABAB... The  $\text{I}^-$  ions may be regarded as an approximately hexagonal close-packed arrangement. The  $\text{Cd}^{2+}$  ions occupy half of the octahedral sites. Rather than half filling the octahedral sites in a regular way throughout the whole structure, all of the octahedral sites are filled between two  $\text{I}^-$  layers, and none of the octahedral sites is filled between the next two layers of  $\text{I}^-$  ions. All of the octahedral holes are filled between the next two layers of  $\text{I}^-$  ions, none between the next pair, and so on.

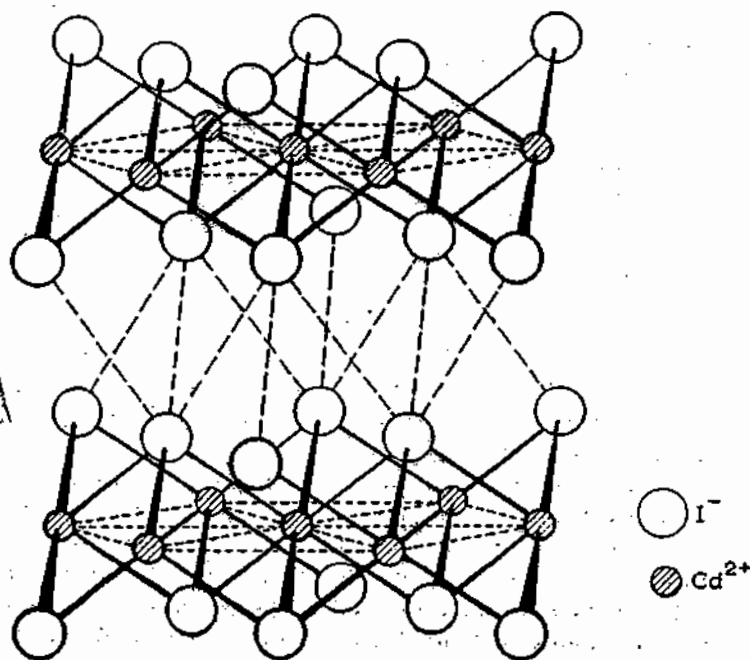

Figure 3.10 Part of two layers of cadmium iodide ( $\text{CdI}_2$ ) structure.

PERPUSTAKAAN  
SARAN KIMIA UNESA

### Cadmium chloride structure

Cadmium chloride forms a closely related layer structure, but in this the chloride ions occur approximately in a cubic close-packed arrangement (ABCABC...).

Layer structures are intermediate in type between the extreme cases of:

1. A totally ionic crystal with a regular arrangement of ions and strong electrostatic forces in all directions.
2. A crystal in which small discrete molecules are held together by weak residual forces such as van der Waals forces and hydrogen bonds.

### Nickel arsenide structure

The structure of nickel arsenide NiAs is related to the structure of  $\text{CdI}_2$ . In NiAs (Figure 3.11), the arsenic atoms form a hexagonal close-packed type of lattice with nickel atoms occupying all of the octahedral sites between all of the layers of arsenic atoms. (In  $\text{CdI}_2$  all of the octahedral sites between half of the layers are filled, whilst with NiAs all of the octahedral sites between all of the layers are filled.)

In the nickel arsenide structure each atom has six nearest neighbours of the other type of atom. Each arsenic atom is surrounded by six nickel atoms at the corners of a trigonal prism. Each nickel atom is surrounded octahedrally by six arsenic atoms, but with two more nickel atoms sufficiently close to be bonded to the original nickel atom. This structure is adopted by many transition elements combined with one of the heavier elements from the *p*-block (Sn, As, Sb, Bi, S, Se, Te) in various alloys. These are better regarded as intermetallic phases rather than true compounds. They are opaque, have metallic lustre, and sometimes have a variable composition.

For details of other ionic structures, such as perovskite and spinels, see Chapter 20 and the Further Reading (Adams, Addison, Douglas McDaniel and Alexander, Greenwood, Wells) at the end of this chapter.

### Structures containing polyatomic ions

There are many ionic compounds of types AX and  $\text{AX}_2$  where A, or X, or both ions are replaced by complex ions. When the complex ion is roughly spherical, the ions often adopt one of the more symmetrical structures described above. Ions such as  $\text{SO}_4^{2-}$ ,  $\text{ClO}_4^-$  and  $\text{NH}_4^+$  are almost spherical. In addition, the transition metal complex  $[\text{Co}(\text{NH}_3)_6]^{2+}$  adopts the  $\text{CaF}_2$  (fluorite) structure.  $\text{K}_2[\text{PtCl}_6]$  adopts an anti-fluorite structure, which is the same as a fluorite structure except that the sites occupied by positive and negative ions are interchanged. Both ions may be complex:  $[\text{Ni}(\text{H}_2\text{O})_6]^{2+}$   $[\text{SnCl}_6]^{2-}$ , for example, forms a slightly distorted CsCl structure. Other ions ( $\text{CN}^-$  and  $\text{SH}^-$ ) sometimes attain effective spherical symmetry by free rotation, or by random orientation. Examples include CsCN, TiCN and CsSH.

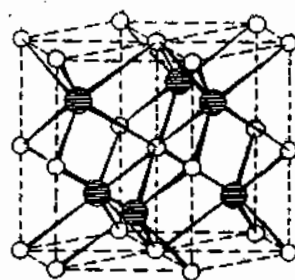
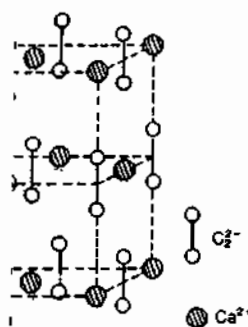

Figure 3.11 Nickel arsenide structure.



2 Calcium carbide

Sometimes the presence of non-spherical ions simply distorts the lattice. Calcium carbide has a face-centred structure like NaCl, except that the linear  $C_2^{2-}$  ions are all oriented in the same direction along one of the unit cell axes. This elongates the unit cell in that direction (Figure 3.12). Similarly calcite,  $CaCO_3$ , has a structure related to NaCl, but the planar triangular  $CO_3^{2-}$  ion distorts the unit cell along a threefold axis of symmetry, rather than along one of the cell axes. Several divalent metal carbonates, a number of nitrates,  $LiNO_3$  and  $NaNO_3$ , and some borates,  $ScBO_3$ ,  $YBO_3$  and  $InBO_3$ , also have the calcite structure.

### A MORE CRITICAL LOOK AT RADIUS RATIOS

To a first approximation, the relative numbers and sizes of the ions will determine the structure of the crystal. The radius ratios of the alkali metal halides and the alkaline earth metal oxides, sulphides, selenides and tellurides are shown in Table 3.3.

All of the crystals with a radius ratio between 0.41 and 0.73 (enclosed by full line in Table 3.3) would be expected to have the sodium chloride structure. In fact all but four of the compounds listed have a sodium chloride structure at normal temperatures. A lot more compounds adopt the NaCl structure than would be predicted. The exceptions are CsCl, CsBr and CsI, which have a caesium chloride structure, and MgTe, which has a zinc sulphide structure. RbCl and RbBr are unusual since they both form a NaCl structure with a coordination number of 6 when crystallized at normal room temperatures and pressures, but they adopt a CsCl structure with a coordination number of 8 if crystallized at high pressures or temperatures. The fact that they can form both structures indicates that the difference in lattice energy between the two structures is small, and hence there is only a small difference in stability between them.

### A CAUTIONARY WORD ON RADIUS RATIOS

Radius ratios provide a useful guide to what is possible on geometric grounds, and also a first guess at the likely structure, but there are other factors involved. Radius ratios do not necessarily provide a completely reliable method for predicting which structure is actually adopted.

Table 3.3 Radius ratios of Group I halides and Group II oxides

	$F^-$	$Cl^-$	$Br^-$	$I^-$		$O^{2-}$	$S^{2-}$	$Se^{2-}$	$Te^{2-}$
$Li^+$	0.57	0.41	0.39	0.35	Be				
$Na^+$	0.77	0.55	0.52	0.46	$Mg^{2+}$	0.51	0.39	0.36	0.33
$K^+$	0.96*	0.75	0.70	0.63	$Ca^{2+}$	0.71	0.54	0.51	0.45
$Rb^+$	0.88*	0.83	0.78	0.69	$Sr^{2+}$	0.84	0.64	0.60	0.53
$Cs^+$	0.80*	0.91	0.85	0.76	$Ba^{2+}$	0.96	0.73	0.68	0.61

\* Indicates reciprocal value of  $r^-/r^+$  since the normal ratio is greater than unity.

Though radius ratios indicate the correct structure in many cases, there are a significant number of exceptions where they predict the wrong structure. It is therefore worth examining the assumptions behind the radius ratio concept, to see if they are valid. The assumptions are:

1. That accurate ionic radii are known.
2. That ions behave as hard inelastic spheres.
3. That stable arrangements are only possible if the positive and negative ions touch.
4. That ions are spherical in shape.
5. That ions always adopt the highest possible coordination number.
6. That bonding is 100% ionic.

Values for ionic radii cannot be measured absolutely, but are estimated. They are not completely accurate or reliable. Though it is possible to measure the interatomic distance between two different ions very accurately by X-ray crystallography, it is much less certain how to divide the distance between the two ions to obtain ionic radii. Furthermore the radius of an ion is not constant but changes depending on its environment. In particular the radius changes when the coordination number changes. The radii usually quoted are for a coordination number of 6, but the radius effectively increases 3% when the coordination number is changed from 6 to 8, and decreases 6% when the coordination number changes from 6 to 4.

Ions are not hard inelastic spheres. They are sometimes fitted into 'holes' that are slightly too small, that is the ions are compressed, and the lattice may be distorted.

The assumption that the ions touch is necessary to calculate the critical lower limit for radius ratios. In principle positive and negative ions should touch, so as to get the ions close together, and get the maximum electrostatic attraction: (Electrostatic attraction depends on the product of the charges on the ions divided by the distance between them.) Theoretically structures where the smaller metal ion 'rattles' in its hole (that is, it does not touch the neighbouring negative ions) should be unstable. A more favourable electrostatic attraction should be obtained by adopting a different geometric arrangement with a smaller coordination number, so that the ions can get closer. It has already been shown that in the alkali halides and alkaline earth oxides the NaCl structure with coordination numbers of 6:6 is sometimes adopted when other structures are predicted by radius ratios. It follows that, since the smaller ion no longer fits the site it occupies, it must either 'rattle', or be compressed.

Are ions spherical? It is reasonable to consider ions with a noble gas structure as spherical. This includes the majority of the ions formed by elements in the main groups. There are a small number of exceptions where the ions have an inert pair ( $\text{Ga}^+$ ,  $\text{In}^+$ ,  $\text{Tl}^+$ ,  $\text{Sn}^{2+}$ ,  $\text{Pb}^{2+}$ ,  $\text{I}^+$ ,  $\text{I}^{3+}$ ). These ions do not have a centre of symmetry, and the structures they form usually show some distortion, with the metal ion slightly displaced off-centre from its expected position. Transition metal ions with partially filled *d* orbitals are not spherical, though in contrast to inert pair distortion they

usually have a centre of symmetry. The arrangement of electrons in these  $d$  orbitals gives rise to Jahn–Teller distortion. (See Chapter 28.) A partially filled  $d$  orbital pointing towards a coordinated ion will repel it. A completely filled  $d$  orbital will repel the ion even more. This can give rise to a structure with some long and some short bonds, depending on both the electronic structure of the metal ion, and the crystal structure adopted, i.e. the positions of the coordinating ions.

It is most unlikely that bonding is ever 100% ionic. The retention of a NaCl structure by a number of compounds which might be expected to adopt a CsCl structure is largely because there is a small covalent contribution to the bonding. The three  $p$  orbitals are at  $90^\circ$  to each other, and in a NaCl structure they point towards the six nearest neighbours, so covalent overlap of orbitals is possible. The geometric arrangement of the NaCl structure is ideally suited to allow some covalent contribution to bonding. This is not so for the CsCl structure.

*Thus radius ratios provide a rough guide to what structures are geometrically possible. Radius ratios often predict the correct structure, but they do not always predict the correct structure. Ultimately the reason why any particular crystal structure is formed is that it gives the most favourable lattice energy.*

### LATTICE ENERGY

The lattice energy ( $U$ ) of a crystal is the energy evolved when one gram molecule of the crystal is formed from gaseous ions:



Lattice energies cannot be measured directly, but experimental values are obtained from thermodynamic data using the Born–Haber cycle (see Chapter 6).

Theoretical values for lattice energy may be calculated. The ions are treated as point charges, and the electrostatic (coulombic) energy  $E$  between two ions of opposite charge is calculated:

$$E = -\frac{z^+ z^- e^2}{r}$$

where

$z^+$  and  $z^-$  are the charges on the positive and negative ions

$e$  is the charge on an electron

$r$  is the inter-ionic distance

For more than two ions, the electrostatic energy depends on the number of ions, and also on  $A$  their arrangement in space. For one mole, the attractive energy is:

$$E = -\frac{N_0 A z^+ z^- e^2}{r}$$



Table 3.4 Madelung constants

Type of structure	$A$	$M$
zinc blende ZnS	1.63806	1.63806
wurtzite ZnS	1.64132	1.64132
sodium chloride NaCl	1.74756	1.74756
caesium chloride CsCl	1.76267	1.76267
rutile TiO <sub>2</sub>	2.408	4.816
fluorite CaF <sub>2</sub>	2.51939	5.03878
corundum Al <sub>2</sub> O <sub>3</sub>	4.17186	25.03116

where

$N_0$  is the Avogadro constant – the number of molecules in a mole – which has the value  $6.023 \times 10^{23} \text{ mol}^{-1}$

$A$  is the Madelung constant, which depends on the geometry of the crystal

Values for the Madelung constant have been calculated for all common crystal structures, by summing the contributions of all the ions in the crystal lattice. Some values are given in Table 3.4. (It should be noted that different values from these are sometimes given where the term  $z^+z^-$  is replaced by  $z^2$ , where  $z$  is the highest common factor in the charges on the ions. The Madelung constant is rewritten  $M = Az^+z^-/z^2$ . This practice is not recommended.)

The equation for the attractive forces between the ions gives a negative value for energy, that is energy is given out when a crystal is formed. The inter-ionic distance  $r$  occurs in the denominator of the equation. Thus the smaller the value of  $r$ , the greater the amount of energy evolved when the crystal lattice is formed, and hence the more stable the crystal will be. Mathematically, the equation suggests that an infinite amount of energy should be evolved if the distance  $r$  is zero. Plainly this is not so. When the inter-ionic distance becomes small enough for the ions to touch, they begin to repel each other. This repulsion originates from the mutual repulsion of the electron clouds on the two atoms or ions. The repulsive forces increase rapidly as  $r$  decreases. The repulsive force is given by  $B/r^n$ , where  $B$  is a

Table 3.5 Average values for the Born exponent

Electronic structure of ion	$n$	Examples
He	5	Li <sup>+</sup> , Be <sup>2+</sup>
Ne	7	Na <sup>+</sup> , Mg <sup>2+</sup> , O <sup>2-</sup> , F <sup>-</sup>
Ar	9	K <sup>+</sup> , Ca <sup>2+</sup> , S <sup>2-</sup> , Cl <sup>-</sup> , Cu <sup>+</sup>
Kr	10	Rb <sup>+</sup> , Br <sup>-</sup> , Ag <sup>+</sup>
Xe	12	Cs <sup>+</sup> , I <sup>-</sup> , Au <sup>+</sup>

Average values are used, e.g. in LiCl, Li<sup>+</sup> = 5, Cl<sup>-</sup> = 9, hence for LiCl,  $n = (5 + 9)/2 = 7$

constant that depends on the structure, and  $n$  is a constant called the Born exponent. For one gram molecule the total repulsive force is  $(N_o B)/r^n$ . The Born exponent may be determined from compressibility measurements. Often chemists use a value of 9, but it is better to use values for the particular ions in the crystal.

The total energy holding the crystal together is  $U$  the lattice energy. This is the sum of the attractive and the repulsive forces.

$$U = \underbrace{-\frac{N_o A z^+ z^- e^2}{r}}_{\text{attractive force}} + \underbrace{\frac{N_o B}{r^n}}_{\text{repulsive force}} \quad (3.1)$$

( $A$  is the Madelung constant and  $B$  is a repulsion coefficient, which is a constant which is approximately proportional to the number of nearest neighbours.)

The equilibrium distance between ions is determined by the balance between the attractive and repulsion terms. At equilibrium,  $dU/dr = 0$ , and the equilibrium distance  $r = r_o$

$$\frac{dU}{dr} = \frac{N_o A z^+ z^- e^2}{r_o^2} - \frac{n N_o B}{r_o^{n+1}} = 0 \quad (3.2)$$

Rearranging this gives an equation for the repulsion coefficient  $B$ .

$$B = \frac{A z^+ z^- e^2 r_o^{n-1}}{n}$$

Substituting equation (3.3) into (3.1)

$$U = -\frac{N_o A z^+ z^- e^2}{r_o} \left(1 - \frac{1}{n}\right)$$

This equation is called the *Born-Landé equation*. It allows the lattice energy to be calculated from a knowledge of the geometry of the crystal, and hence the Madelung constant, the charges  $z^+$  and  $z^-$ , and the inter-ionic distance. When using SI units, the equation takes the form:

$$U = -\frac{N_o A z^+ z^- e^2}{4\pi\epsilon_o r_o} \left(1 - \frac{1}{n}\right) \quad (3.4)$$

where  $\epsilon_o$  is the permittivity of free space =  $8.854 \times 10^{-12} \text{ F m}^{-1}$ .

This equation gives a calculated value of  $U = -778 \text{ kJ mol}^{-1}$  for the lattice energy for sodium chloride, which is close to the experimental value of  $-77 \text{ kJ mol}^{-1}$  at  $25^\circ\text{C}$  (obtained using the Born-Haber cycle). The experimental and theoretical values for the alkali metal halides and the oxides and halides of the alkaline earths (excluding Be), all agree within 3%.

Other expressions, for example the Born-Mayer and Kapustinskii equations, are similar, but calculate the repulsive contribution in a slightly different way. Agreement is even better if allowances are made for van der Waals forces and zero point energy.

Several important points arise from the Born-Landé equation:

1. The lattice becomes stronger (i.e. the lattice energy  $U$  becomes more negative), as  $r$  the inter-ionic distance decreases.  $U$  is proportional to  $1/r$ .

	$r$ (Å)	$U$ (kJ mol <sup>-1</sup> )
LiF	2.01	-1004
CsI	3.95	-527

2. The lattice energy depends on the product of the ionic charges, and  $U$  is proportional to  $(z^+ \cdot z^-)$ .

	$r$ (Å)	$(z^+ \cdot z^-)$	$U$ (kJ mol <sup>-1</sup> )
LiF	2.01	1	-1004
MgO	2.10	4	-3933

3. The close agreement between the experimental lattice energies and those calculated by the Born-Landé equation for the alkali metal halides does not of itself prove that the equation itself, or the assumptions on which it is based, are correct. The equation is remarkably self-compensating, and tends to hide errors. There are two opposing factors in the equation. Increasing the inter-ionic distance  $r$  reduces the lattice energy. It is almost impossible to change  $r$  without changing the structure, and therefore changing the Madelung constant  $A$ . Increasing  $A$  increases the lattice energy: hence the effects of changing  $r$  and  $A$  may largely cancel each other.

This may be illustrated by choosing a constant value for  $n$  in the Born-Landé equation. Then changes in inter-ionic distance can be calculated for either changes in the coordination number, or in crystal structure. Taking a constant value of  $n = 9$ , we may compare the inter-ionic distances with those for six-coordination:

Coordination number	12	8	6	4
Ratio of inter-ionic distance	1.091	1.037	1.000	0.951

For a change of coordination number from 6 (NaCl structure) to 8 (CsCl structure) the inter-ionic distance increases by 3.7%, and the Madelung constants (NaCl  $A = 1.74756$ , and CsCl  $A = 1.76267$ ) change by only 0.9%. Thus a change in coordination number from 6 to 8 would result in a reduction in lattice energy, and in theory the NaCl structure should always be more stable than the CsCl structure. In a similar way reducing the coordination number from 6 to 4 decreases  $r$  by 4.9%. The decrease in  $A$  is 6.1% or 6.3% (depending on whether a zinc blende or wurtzite structure is formed), but in either case it more than compensates for the change in  $r$ , and in theory coordination number 6 is more stable than 4.

This suggests that neither four- nor eight-coordinate structures should exist, since the six-coordinate NaCl structure is more stable. Since ZnS is known (coordination number 4), and CsCl, CsBr and CsI have a coordination number of 8, this suggestion is plainly incorrect. We must

Table 3.6 Inter-ionic distances and ionic charges related to m.p. and hardness

	$r(\text{\AA})$	$(z^+ \cdot z^-)$	m.p. ( $^{\circ}\text{C}$ )	Hardness (Mohs' scale)
NaF	2.310	1	990	3.2
BeO	1.65	4	2530	9.0
MgO	2.106	4	2800	6.5
CaO	2.405	4	2580	4.5
SrO	2.580	4	2430	3.5
BaO	2.762	4	1923	3.3
TiC	2.159	16	3140	8-9

therefore look for a mistake in the theoretical assumptions made. First the value of  $n$  was assumed to be 9, when it may vary from 5 to 12. Second, the calculation of electrostatic attraction assumes that the ions are point charges. Third, the assumption is made that there is no reduction in charge because of the interaction (i.e. the bonds are 100% ionic).

4. Crystals with a high lattice energy usually melt at high temperatures, and are very hard. Hardness is measured on Mohs' scale. (See Appendix N.) High lattice energy is favoured by a small inter-ionic distance, and a high charge on the ions.

It has been seen that a number of salts which might be expected from radius ratio considerations to have a CsCl structure in fact adopt a NaCl structure. The Madelung constant for CsCl is larger than for NaCl, and would give an increased lattice energy. However, the inter-ionic distance  $r$  will be larger in a CsCl type of structure than in a NaCl type of structure, and this would decrease the lattice energy. These two factors work in opposite directions and partly cancel each other. This makes the lattice energy more favourable for a NaCl type of lattice in some cases where a CsCl structure is geometrically possible. Consider a case such as RbBr, where the radius ratio is close to borderline between six-coordination (NaCl structure) and eight-coordination (CsCl structure). If the CsCl structure is adopted, the Madelung constant is larger than for NaCl, and *this increases the lattice energy by 0.86%*. At the same time the inter-ionic distance in a CsCl structure increases by 3%, and *this decreases the lattice energy by 3%*. Clearly the NaCl structure is preferred.

#### FEATURES OF SOLIDS

The essential feature of crystalline solids is that the constituent molecules, atoms or ions are arranged in a completely regular three-dimensional pattern. Models built to show the detailed structure of crystalline materials are usually grossly misleading, for they imply a perfect static pattern. Since the atoms or ions have a considerable degree of thermal vibration, the

crystalline state is far from static, and the pattern is seldom perfect. Many of the most useful properties of solids are related to the thermal vibrations of atoms, the presence of impurities and the existence of defects.

### STOICHIOMETRIC DEFECTS

Stoichiometric compounds are those where the numbers of the different types of atoms or ions present are exactly in the ratios indicated by their chemical formulae. They obey the law of constant composition that *'the same chemical compound always contains the same elements in the same composition by weight'*. At one time these were called Daltonide compounds, in contrast to Berthollide or nonstoichiometric compounds where the chemical composition of a compound was variable, not constant.

Two types of defects may be observed in stoichiometric compounds, called Schottky and Frenkel defects respectively. At absolute zero, crystals tend to have a perfectly ordered arrangement. As the temperature increases, the amount of thermal vibration of ions in their lattice sites increases, and if the vibration of a particular ion becomes large enough, it may jump out of its lattice site. This constitutes a point defect. The higher the temperature, the greater the chance that lattice sites may be unoccupied. Since the number of defects depends on the temperature, they are sometimes called thermodynamic defects.

#### Schottky defects

A Schottky defect consists of a pair of 'holes' in the crystal lattice. One positive ion and one negative ion are absent (see Figure 3.13). This sort of defect occurs mainly in highly ionic compounds where the positive and negative ions are of a similar size, and hence the coordination number is high (usually 8 or 6), for example NaCl, CsCl, KCl and KBr.

The number of Schottky defects formed per  $\text{cm}^3$  ( $n_s$ ) is given by

$$n_s = N \exp\left(-\frac{W_s}{2kT}\right)$$

where  $N$  is the number of sites per  $\text{cm}^3$  that could be left vacant,  $W_s$  is the work necessary to form a Schottky defect,  $k$  is the gas constant and  $T$  the absolute temperature.

#### Frenkel defects

A Frenkel defect consists of a vacant lattice site (a 'hole'), and the ion which ideally should have occupied the site now occupies an interstitial position (see Figure 3.14).

Metal ions are generally smaller than the anions. Thus it is easier to squeeze  $A^+$  into alternative interstitial positions, and consequently it is more common to find the positive ions occupying interstitial positions. This type of defect is favoured by a large difference in size between the positive

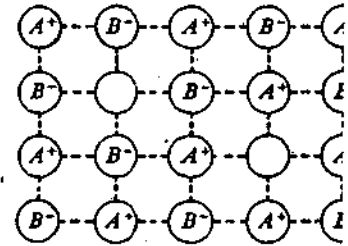

Figure 3.13 Schottky defect.

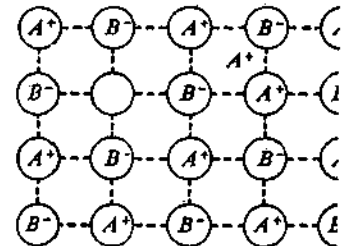

Figure 3.14 Frenkel defect.

and negative ions, and consequently the coordination number is usually low (4 or 6). Since small positive ions are highly polarizing and large negative ions are readily polarized, these compounds have some covalent character. This distortion of ions, and the proximity of like charges, leads to a high dielectric constant. Examples of this type of defect are ZnS, AgCl, AgBr and AgI.

The number of Frenkel defects formed per  $\text{cm}^3$  ( $n_f$ ) is given by

$$n_f = \sqrt{NN'} \exp\left(-\frac{W_f}{2kT}\right)$$

where  $N$  is the number of sites per  $\text{cm}^3$  that could be left vacant,  $N'$  is the number of alternative interstitial positions per  $\text{cm}^3$ ,  $W_f$  is the work necessary to form a Frenkel defect,  $k$  is the gas constant and  $T$  the absolute temperature.

The energy needed to form either a Schottky defect or a Frenkel defect depends on the work needed to form the defect, and on the temperature. In a given compound one type generally predominates.

In NaCl, the energy to form a Schottky defect is about  $2003\text{kJ mol}^{-1}$  compared with a lattice energy of approximately  $750\text{kJ mol}^{-1}$ . It is therefore much easier to form a defect than to break the lattice.

The number of defects formed is relatively small, and at room temperature NaCl has only one defect in  $10^{15}$  lattice sites, this value rising to one in  $10^6$  sites at  $500^\circ\text{C}$  and one in  $10^4$  sites at  $800^\circ\text{C}$ .

A consequence of these defects is that a crystalline solid that has defects may conduct electricity to a small extent. Electrical conductivity in a chemically pure, stoichiometric semiconductor is called '*intrinsic semiconduction*'. In the above cases, intrinsic semiconduction occurs by an ionic mechanism. If an ion moves from its lattice site to occupy a 'hole', it creates a new 'hole'. If the process is repeated many times, a 'hole' may migrate across a crystal, which is equivalent to moving a charge in the opposite direction. (This type of semiconduction is responsible for the unwanted background noise produced by transistors.)

Crystals with Frenkel defects have only one type of hole, but crystals containing Schottky defects have holes from both positive and negative ions, and conduction may arise by using either one type of hole or both types. Migration of the smaller ion (usually the positive ion) into the appropriate holes is favoured at low temperatures, since moving a small

Table 3.7. Percentage of conduction by cations and anions

Temp. ( $^\circ\text{C}$ )	NaF		NaCl		NaBr	
	cation %	anion %	cation %	anion %	cation %	anion %
400	100	0	100	0	98	2
500	100	0	98	2	94	6
600	92	8	91	9	89	11

ion requires less energy. However, migration of both types of ions in opposite directions (using both types of holes) occurs at high temperatures. For example, at temperatures below 500°C the alkali halides conduct by migration of the cations, but at higher temperatures both anions and cations migrate. Further, the amount of anionic conduction increases with temperature, as shown in Table 3.7.

The density of a defect lattice should be different from that of a perfect lattice. The presence of 'holes' should lower the density, but if there are too many 'holes' there may be a partial collapse or distortion of the lattice – in which case the change in density is unpredictable. The presence of ions in interstitial positions may distort (expand) the lattice and increase the unit cell dimensions.

### NONSTOICHIOMETRIC DEFECTS

Nonstoichiometric or Berthollide compounds exist over a range of chemical composition. The ratio of the number of atoms of one kind to the number of atoms of the other kind does not correspond exactly to the ideal whole number ratio implied by the formula. Such compounds do not obey the law of constant composition. There are many examples of these compounds, particularly in the oxides and sulphides of the transition elements. Thus in FeO, FeS or CuS the ratio of Fe:O, Fe:S or Cu:S differs from that indicated by the ideal chemical formula. If the ratio of atoms is not exactly 1:1 in the above cases, there must be either an excess of metal ions, or a deficiency of metal ions (e.g.  $\text{Fe}_{0.84}\text{O}$ – $\text{Fe}_{0.94}\text{O}$ ,  $\text{Fe}_{0.9}\text{S}$ ). Electrical neutrality is maintained either by having extra electrons in the structure, or changing the charge on some of the metal ions. This makes the structure irregular in some way, i.e. it contains defects, which are in addition to the normal thermodynamic defects already discussed.

#### Metal excess

This may occur in two different ways.

#### *F-centres*

A negative ion may be absent from its lattice site, leaving a 'hole' which is occupied by an electron, thereby maintaining the electrical balance (see Figure 3.15). This is rather similar to a Schottky defect in that there are 'holes' and not interstitial ions, but only one 'hole' is formed rather than a pair. This type of defect is formed by crystals which would be expected to form Schottky defects. When compounds such as NaCl, KCl, LiH or  $\delta$ -TiO are heated with excess of their constituent metal vapours, or treated with high energy radiation, they become deficient in the negative ions, and their formulae may be represented by  $\text{AX}_{1-\delta}$ , where  $\delta$  is a small fraction. The nonstoichiometric form of NaCl is yellow, and the nonstoichiometric

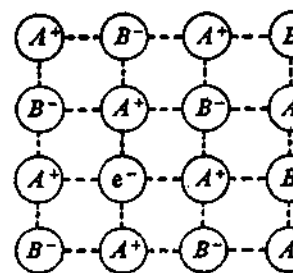
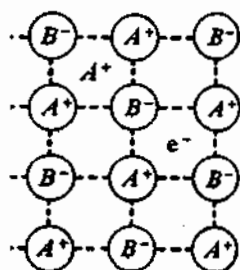

Figure 3.15 Metal excess defect because of absent anion.

form of KCl is blue-lilac in colour. Note the similarity with the flame colorations for Na and K.

The crystal lattice has vacant anion sites, which are occupied by electrons. Anion sites occupied by electrons in this way are called *F-centres*. (*F* is an abbreviation for *Farbe*, the German word for colour.) These *F-centres* are associated with the colour of the compound and the more *F-centres* present, the greater the intensity of the coloration. Solids containing *F-centres* are paramagnetic, because the electrons occupying the vacant sites are unpaired. When materials with *F-centres* are irradiated with light they become photoconductors. When electrons in the *F-centres* absorb sufficient light (or heat) energy, the electron is promoted into a conduction band, rather similar to the conduction bands present in metals. Since conduction is by electrons it is *n-type semiconduction*.



16 Metal excess defects interstitial cations.

#### Interstitial ions and electrons

Metal excess defects also occur when an extra positive ion occupies an interstitial position in the lattice, and electrical neutrality is maintained by the inclusion of an interstitial electron (see Figure 3.16). Their composition may be represented by the general formula  $A_{1+\delta}X$ .

This type of defect is rather like a Frenkel defect in that ions occupy interstitial positions, but there are no 'holes', and there are also interstitial electrons. This kind of metal excess defect is much more common than the first, and is formed in crystals which would be expected to form Frenkel defects (i.e. the ions are appreciably different in size, have a low co-ordination number, and have some covalent character). Examples include ZnO, CdO, Fe<sub>2</sub>O<sub>3</sub> and Cr<sub>2</sub>O<sub>3</sub>.

If this type of defect oxide is heated in oxygen, then cooled to room temperature, its conductivity decreases. This is because the oxygen oxidizes some of the interstitial ions, and these subsequently remove interstitial electrons, which reduces the conductivity.

Crystals with either type of metal excess defect contain free electrons, and if these migrate they conduct an electric current. Since there are only a small number of defects, there are only a few free electrons that can conduct electricity. Thus the amount of current carried is very small compared with that in metals, fused salts or salts in aqueous solutions, and these defect materials are called *semiconductors*. Since the mechanism is normal electron conduction, these are called *n-type semiconductors*. These free electrons may be excited to higher energy levels giving absorption spectra, and in consequence their compounds are often coloured, e.g. nonstoichiometric NaCl is yellow, nonstoichiometric KCl is lilac, and ZnO is white when cold but yellow when hot.

#### Metal deficiency

Metal-deficient compounds may be represented by the general formula  $A_{1-\delta}X$ . In principle metal deficiency can occur in two ways. Both require



variable valency of the metal, and might therefore be expected with the transition metals.

#### *Positive ions absent*

If a positive ion is absent from its lattice site, the charges can be balanced by an adjacent metal ion having an extra positive charge (see Figure 3.17). Examples of this are FeO, NiO,  $\delta$ -TiO, FeS and CuI. (If an  $\text{Fe}^{2+}$  is missing from its lattice site in FeO, then there must be two  $\text{Fe}^{3+}$  ions somewhere in the lattice to balance the electrical charges. Similarly if a  $\text{Ni}^{2+}$  is missing from its lattice site in NiO, there must be two  $\text{Ni}^{3+}$  present in the lattice.)

Crystals with metal deficiency defects are semiconductors. Suppose the lattice contains  $\text{A}^+$  and  $\text{A}^{2+}$  metal ions. If an electron 'hops' from an  $\text{A}^+$  ion to the positive centre (an  $\text{A}^{2+}$  ion), the original  $\text{A}^+$  becomes a new positive centre. There has been an apparent movement of  $\text{A}^{2+}$ . With a series of similar 'hops', an electron may be transferred in one direction across the structure, and at the same time the positive hole migrates in the opposite direction across the structure. This is called positive hole, or *p-type semiconduction*.

If a defect oxide of this type is heated in oxygen, its room temperature conductivity increases, because the oxygen oxidizes some of the metal ions, and this increases the number of positive centres.

#### *Extra interstitial negative ions*

In principle it might be possible to have an extra negative ion in an interstitial position and to balance the charges by means of an extra charge on an adjacent metal ion (see Figure 3.18). However, since negative ions are usually large, it would be difficult to fit them into interstitial positions. No examples of crystals containing such negative interstitial ions are known at present.

## SEMICONDUCTORS AND TRANSISTORS

Semiconductors are solids where there is only a small difference in energy, called a *band gap*, between the filled valency band of electrons and a conduction band. If cooled to absolute zero, the electrons occupy their lowest possible energy levels. The conduction band is empty, and the material is a perfect insulator. At normal temperatures, some electrons are thermally excited from the valency band to the conduction band, and hence they can conduct electricity by the passage of electrons at normal temperatures. The conductivity is in between that of a metal and an insulator and depends on the number of electrons in the conduction band.

Germanium and, to an even greater extent, silicon are the most important commercial examples of semiconductors. The crystal structures of both are like diamond. Atoms of Si and Ge both have four electrons in their outer shell, which form four covalent bonds to other atoms. In both

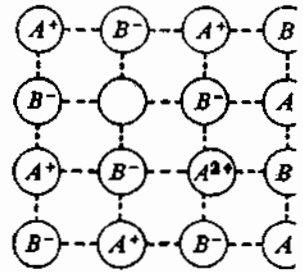

Figure 3.17 Metal deficiency caused by missing positive ion

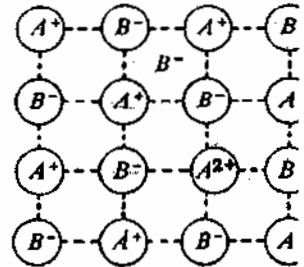

Figure 3.18 Metal deficiency caused by interstitial negative ions.

Table 3.8 Band gaps of some semiconductors at absolute zero

Compound	Energy gap (kJ mol <sup>-1</sup> )	Compound	Energy gap (kJ mol <sup>-1</sup> )
α-Sn	0	GaAs	145
PbTe	19	Cu <sub>2</sub> O	212
Te	29	CdS	251
PbS	29	GaP	278
Ge	68	ZnO	328
Si	106	ZnS	376
InP	125	Diamond	579

Si and Ge at very low temperatures, the valence band is filled and the conduction band is empty. Under these conditions, Si and Ge are both insulators, and cannot carry any electric current.

The band gaps are only 68 kJ mol<sup>-1</sup> for Ge, and 106 kJ mol<sup>-1</sup> for Si, and at room temperature a few valence electrons gain sufficient energy from the thermal vibration of the atoms to be promoted into the conduction band. If the crystal is connected in an electric circuit, these thermally excited electrons carry a small current, and make the Si or Ge crystal slightly conducting. This is termed *intrinsic semiconduction*. Expressed in another way, some bonds are broken, and these valence electrons can migrate, and conduct electricity.

As the temperature is increased, the conductivity increases, that is the electrical resistance decreases. (This is the opposite of the situation with metals.) Above 100°C, so many valence electrons are promoted to the conduction band in Ge that the crystal lattice disintegrates. With Si the maximum working temperature is 150°C. This intrinsic semiconduction is undesirable, and precautions must be taken to limit the working temperature of transistors.

Pure Si and Ge can be made semiconducting in a controlled way by adding impurities which act as charge carriers. Si or Ge are first obtained extremely pure by zone refining. Some atoms with five outer electrons, such as arsenic As, are deliberately added to the silicon crystal. This process is called 'doping' the crystal. A minute proportion of Si atoms are randomly replaced by As atoms with five electrons in their outer shell. Only four of the outer electrons on each As atom are required to form bonds in the lattice. At absolute zero or low temperatures, the fifth electron is localized on the As atom. However, at normal temperatures, some of these fifth electrons on As are excited into the conduction band, where they can carry current quite readily. This is *extrinsic conduction*, and it increases the amount of semiconduction far above that possible by intrinsic conduction. Since the current is carried by excess electrons, it is *n-type semiconduction*.

Alternatively a crystal of pure Si may be doped with some atoms with only three outer electrons, such as indium In. Each indium atom uses its

three outer electrons to form three bonds in the lattice, but they are unable to form four bonds to complete the covalent structure. One bond is incomplete, and the site normally occupied by the missing electron is called a 'positive hole'. At absolute zero or low temperatures, the positive holes are localized around the indium atoms. However, at normal temperatures a valence electron on an adjacent Si atom may gain sufficient energy to move into the hole. This forms a new positive hole on the Ge atom. The positive hole seems to have moved in the opposite direction to the electron. By a series of 'hops', the 'positive hole' can migrate across the crystal. This is equivalent to moving an electron in the opposite direction, and thus current is carried. Since current is carried by the migration of positive centres, this is *p-type semiconduction*.

Silicon must be ultra-highly purified before it can be used in semiconductors. First impure silicon (98% pure) is obtained by reducing  $\text{SiO}_2$  with carbon in an electric furnace at about  $1900^\circ\text{C}$ . This may be purified by reacting with  $\text{HCl}$ , forming trichlorosilane  $\text{SiHCl}_3$ , which may be distilled to purify it, then decomposed by heating to give pure silicon.

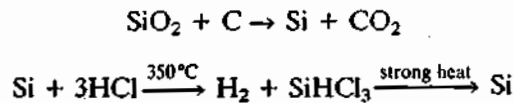

The final purification is by zone refining, where a rod of silicon is melted near one end by an electric furnace. As the furnace is slowly moved along the rod, the narrow molten zone gradually moves to the other end of the rod. The impurities are more soluble in the liquid melt than in the solid, so they concentrate in the molten zone, and eventually move to the end of the rod. The impure end is removed, leaving an ultra-purified rod, with a purity of at least 1 part in  $10^{10}$ . Purified silicon (or germanium) crystals can be converted to *p*-type or *n*-type semiconductors by high temperature diffusion of the appropriate dopant element, up to a concentration of 1 part in  $10^8$ . In principle any of the Group III elements boron, aluminium, gallium or indium can be used to make *p*-type semiconductors, though indium is the most used because of its low melting point. Similarly Group V elements such as phosphorus or arsenic can be used to make *n*-type semiconductors, but because of its low melting point arsenic is most used.

If a single crystal is doped with indium at one end, and with arsenic at the other end, then one part is a *p*-type semiconductor and the other an *n*-type semiconductor. In the middle there will be a boundary region where the two sides meet, which is a *p-n* junction. Such junctions are the important part of modern semiconductor devices.

## RECTIFIERS

A rectifier will only allow current from an outside source to flow through it in one direction. This is invaluable in converting alternating current AC into direct current DC, and it is common to use a square of four diodes in a

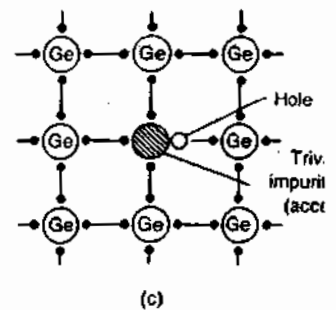
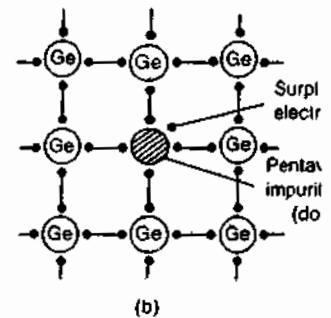
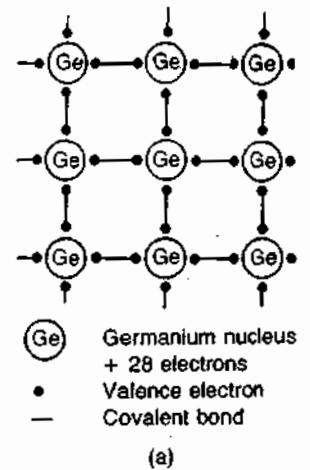
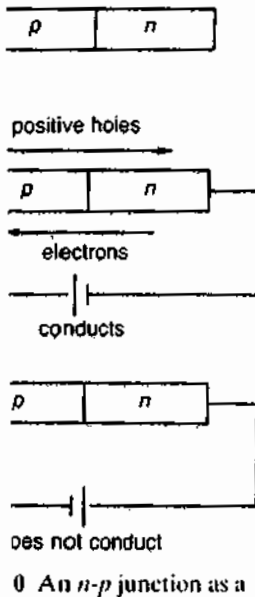

Figure 3.19 (a) Pure germanium. (b) *n*-type germanium. (c) *p*-type germanium.



circuit to do this. A diode is simply a transistor with two zones, one *p*-type, and the other *n*-type, with a *p-n* junction in between.

Suppose that a positive voltage is applied to the *p*-type region, and a negative (or more negative) voltage applied to the *n*-type region. In the *p*-type region, positive holes will migrate towards the *p-n* junction. In the *n*-type region, electrons will migrate towards the junction. At the junction, the two destroy each other. Expressed in another way, at the junction the migrating electrons from the *n*-type region move into the vacant holes in the valence band of the *p*-type region. The migration of electrons and holes can continue indefinitely, and a current will flow for as long as the external voltage is applied.

Consider what will happen if the voltages are reversed, so the *p*-type region is negative, and the *n*-type region positive. In the *p*-type region, positive holes migrate away from the junction, and in the *n*-type region electrons migrate away from the junction. At the junction there are neither positive holes nor electrons, so no current can flow.

### PHOTOVOLTAIC CELL

If a *p-n* junction is irradiated with light, provided that the energy of the light photons exceeds the band gap, then some bonds will break, giving electrons and positive holes, and these electrons are promoted from the valence band to the conduction band. The extra electrons in the conduction band make the *n*-type region more negative, whilst in the *p*-type region the electrons are trapped by some positive holes. If the two regions are connected in an external circuit, then electrons can flow from the *n*-type region to the *p*-type region, that is current flows from the *p*-type to the *n*-type region. Such a device acts as a battery that can generate electricity from light. Efforts are being made to make efficient cells of this type to harness solar energy.

### TRANSISTORS

Transistors are typically single crystals of silicon which have been doped to give three zones. In Britain *p-n-p* transistors are mainly used, whilst in the USA *n-p-n* transistors are most widely used. Both types have many uses, for example as amplifiers and oscillators in radio, TV and hi-fi circuits and in computers. They are also used as phototransistors, tunnel diodes, solar cells, thermistors, and in the detection of ionizing radiation.

Different voltages must be applied to the three regions of a transistor to make it work. Typical bias potentials for a *p-n-p* transistor are shown in Figure 3.21. The base is typically  $-0.2$  volts and the collector is typically  $-2.0$  volts with respect to the emitter. The charge carriers in the emitter are positive holes, and these migrate from the emitter at 0 volts to the base at  $-0.2$  volts. The positive holes cross the emitter/base *p-n* junction, and in the *n*-type base region some positive holes combine with electrons and are destroyed. There is a flow of electrons in the reverse direction, from the

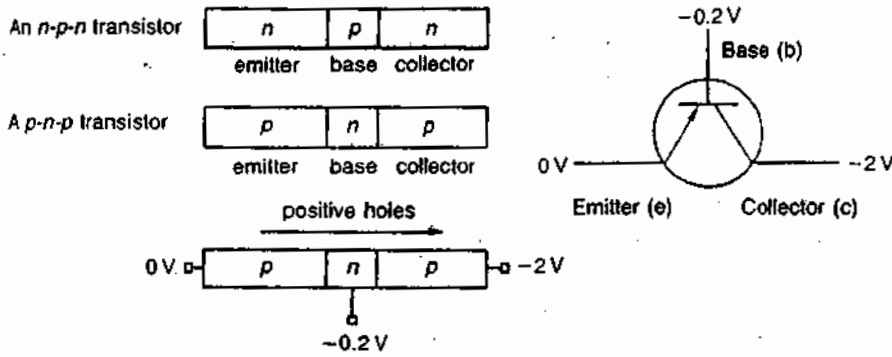

Figure 3.21 *n-p-n* and *p-n-p* transistors.

base to the emitter. There is thus a small base current. However, the base is very thin, and the collector has a much greater negative voltage, so most of the positive holes pass through the base to the collector, where they combine with electrons from the circuit. At the emitter, electrons leave the *p*-type semiconductor and enter the circuit, and in doing so they produce more positive holes. Typically, if the emitter current is 1 mA, the base current is 0.02 mA, and the collector current 0.98 mA.

The most common method of using a transistor as an amplifier is the common or grounded emitter circuit (Figure 3.22a). The emitter is common to both the base and collector circuits, and is sometimes grounded (earthed). The base current is the input signal, and the collector current is the output signal. If the base current is reduced, for example by increasing  $R_1$ , the base becomes positively charged, and this reduces the movement of positive holes to the collector. In a typical transistor, a change in the base current can produce a change 50 times as great in the collector current, giving a current amplification factor of 50. A small change in input current to the base produces a much larger change in the collector current, so the original signal is amplified.

In practice the bias for both the base and the collector are often obtained from one battery by having the resistance of  $R_1$  much greater than that of  $R_2$  (Figure 3.22b).

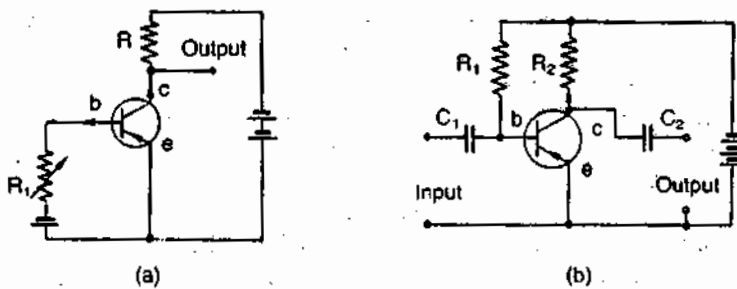

Figure 3.22 Common emitter amplifier circuits. e = emitter, b = base, c = collector.

Finally, *n-p-n* transistors work in a similar way, except that the polarity of the bias voltages is reversed, so the collector and base are positive with respect to the emitter.

### MICRO-MINATURIZED SEMICONDUCTOR DEVICES INTEGRATED CIRCUITS

It is now possible to manufacture computer chips with the equivalent of many thousands of single crystal transistor junctions on a small wafer of silicon, only a few millimetres square. (Memory chips for computers are readily available which store 64K, 256K, 1 megabyte and even 4 megabytes of data on a single chip.)

The steps in the manufacture of such chips is:

1. A fairly large single crystal of Si is doped to make it an *n*-type semiconductor, and then it is carefully cut into thin slices.
2. A slice is heated in air to form a thin surface layer of SiO<sub>2</sub>.
3. The oxide layer is then coated with a photosensitive film, sometimes called a photoresist.
4. A mask is placed over the photoresist, and the slice is exposed to UV light. Those parts of the photoresist exposed to light are changed, and are removed by treatment with acid, but the unexposed parts remain protected by the photoresist.
5. The slice is then treated with HF, which etches (removes) the exposed areas of SiO<sub>2</sub>. After this, the unchanged photoresist is removed.
6. The surface is exposed to the vapour of a Group III element. Some of the surface is covered by a film of SiO<sub>2</sub>, and some has exposed silicon. The parts covered by a SiO<sub>2</sub> film are unaffected, but in the parts where the silicon itself is exposed, some Si atoms are randomly replaced, forming a layer of *p*-type semiconductor.
7. The steps (2) to (5) are repeated using a different mask, and the exposed areas of Si exposed to the vapour of a Group V element, to produce another layer of *n*-type semiconductor.
8. Steps (2) to (5) are repeated using a mask to produce the openings into which metal can be deposited to 'wire together' the various semiconductors so produced into an integrated circuit.
9. Finally the chip is packaged in plastic or ceramic, connecting pins are soldered on so that it may be plugged in to a socket on a circuit board, and the chip is tested. A significant number turn out to be faulty. Faulty chips cannot be repaired, and are discarded.

### FURTHER READING

- Adams, D.M. (1974) *Inorganic Solids*, Wiley-Interscience, New York.  
Addison, W.E. (1961) *Structural Principles in Inorganic Compounds*, Longmans, London.  
Bamfield, P. (ed.) (1986) *Fine Chemicals for the Electronic Industry*, Royal Society of Chemistry, Special Publication No. 40, London.

- Burdett, J.K. (1982) New ways to look at solids, *Acc. Chem. Res.*, 15, 34.
- Cartmell, E. and Fowles, G.W.A. (1977) *Valency and Molecular Structure*, 4th ed., Butterworths, London.
- Cox, P.A. (1987) *The Electronic Structure and Chemistry of Solids*, Oxford University Press.
- Dasent, W.E. (1982) *Inorganic Energetics: An Introduction* (Cambridge Texts in Chemistry and Biochemistry Series), Cambridge University Press.
- Douglas, B., McDaniel, D.H. and Alexander J.J. (1983) *Concepts and Models in Inorganic Chemistry*, 2nd ed., Wiley, New York.
- Ebsworth, E.A.V., Rankin, D.W.H. and Cradock, S. (1987) *Structural Methods in Inorganic Chemistry*, Blackwell Scientific, Oxford.
- Galasso, F.S. (1970) *Structure and Properties of Inorganic Solids*, Pergamon, Oxford. (Contains extensive tables.)
- Galwey, A.K. (1967) *Chemistry of Solids*, Chapman & Hall, London.
- Greenwood, N.N. (1968) *Ionic Crystals, Lattice Defects and Non-Stoichiometry*, Butterworths, London. (Still the best single volume book on the subject.)
- Ho, S.M. and Douglas, B.E. (1972) Structures of the elements and the PTOT system, *J. Chem. Ed.*, 49, 74.
- Hyde, B.G. and Andersson, S. (1989) *Inorganic Crystal Structures*, Wiley, New York.
- Jenkins, H.D.B. (1979) The calculation of lattice energy: some problems and some solutions, *Revue de Chimie Minerale*, 16, 134-150.
- Ladd, M.F.C. (1974) *Structure and Bonding in Solid State Chemistry*, Wiley, London.
- Moss, S.J and Ledwith, A. (eds) (1987) *The Chemistry of the Semiconductor Industry*, Blackie.
- Parish, R.V. (1976) *The Metallic Elements*, Longmans, London.
- Rao, C.N.R. (ed.) (1974) *Solid State Chemistry*, Dekker, New York.
- Rao, C.N.R. and Gopalakrishnan, J. (1986) *New Directions in Solid State Chemistry*, Cambridge University Press, Cambridge.
- Shannon R.D. (1976) Revised effective ionic radii. *Acta Cryst.*, A32, 751-767. (The most up to date and generally accepted values for ionic radii.)
- Walton, A. (1978) *Molecular and Crystal Structure Models*, Ellis Horwood, Chichester.
- Wells, A.F. (1984) *Structural Inorganic Chemistry*, 5th ed., Oxford University Press, Oxford. (The standard text, with excellent diagrams.)
- West, A.R. (1984) *Solid State Chemistry and its Applications*, Wiley, New York.

## PROBLEMS

1. Relate the tendency of atoms to gain or lose electrons to the types of bonds they form.
2. Indicate to what extent the following will conduct electricity, and give the mechanism of conduction in each case:
  - (a) NaCl (fused)
  - (b) NaCl (aqueous solution)
  - (c) NaCl (solid)
  - (d) Cu (solid)
  - (e) CCl<sub>4</sub> (liquid).
3. Why are ionic compounds usually high melting, whilst most simple covalent compounds have low melting points? Explain the high melting point of diamond.

4. How are the minimum values of radius ratio arrived at for various coordination numbers, and what are these limits? Give examples of the types of crystal structure associated with each coordination number.
5. Show by means of a diagram, and a simple calculation, the minimum value of the radius ratio  $r^+/r^-$  which permits a salt to adopt a caesium chloride type of structure.
6. Give the coordination numbers of the ions and describe the crystal structures of zinc blende, wurtzite and sodium chloride in terms of close packing and the occupancy of tetrahedral and octahedral holes.
7. CsCl, CsI, TlCl and TlI all adopt a caesium chloride structure. The inter-ionic distances are: Cs-Cl 3.06 Å, Cs-I 3.41 Å, Tl-Cl 2.55 Å and Tl-I 2.90 Å. Assuming that the ions behave as hard spheres and that the radius ratio in TlI has the limiting value, calculate the ionic radii for Cs<sup>+</sup>, Tl<sup>+</sup>, Cl<sup>-</sup>, I<sup>-</sup> in eight-coordination.
8. Write down the Born-Landé equation and define the terms in it. Use the equation to show why some crystals, which according to the radius ratio concept should adopt a coordination number of 8, in fact have a coordination number of 6.
9. Outline a Born-Haber cycle for the formation of an ionic compound MCl. Define the terms used and state how these might be measured or calculated. How do these enthalpy terms vary throughout the periodic table? Use these variations to suggest how the properties of NaCl might differ from those of CuCl.
10. Explain the term lattice energy as applied to an ionic solid. Calculate the lattice energy of caesium chloride using the following data:

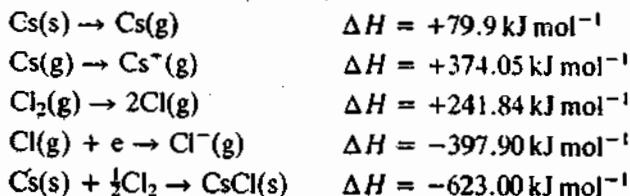

11. (a) Draw the structures of CsCl and TiO<sub>2</sub>, showing clearly the coordination of the cations and anions. (b) Show how the Born-Haber cycle may be used to estimate the enthalpy of the hypothetical reaction:

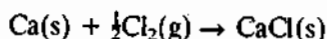

Explain why CaCl(s) has never been made even though the enthalpy for this reaction is negative.

12. The standard enthalpy changes  $\Delta H^\circ$  at 298 K for the reaction:

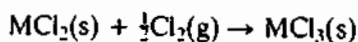



are given for the first row transition metals:

	Sc	Ti	V	Cr	Mn	Fe	Co	Ni	Cu
$\Delta H^\circ/\text{kJ mol}^{-1}$	-339	-209	-138	-160	+22	-59	+131	+280	+357

Use a Born-Haber cycle to account for the change in  $\Delta H^\circ$  as the atomic number of the metal increases. Comment on the relative stabilities of the +II and +III oxidation states of the 3d metals.

13. List the types of defect that occur in the solid state and give an example of each. Explain in each case if any electrical conduction is possible and by what mechanism.

# 4

## The covalent bond

### INTRODUCTION

There are several different theories which explain the electronic structures and shapes of known molecules, and attempt to predict the shape of molecules whose structures are so far unknown. Each theory has its own virtues and shortcomings. None is rigorous. Theories change in the light of new knowledge and fashion. If we knew or could prove what a bond was, we would not need theories, which by definition cannot be proved. The value of a theory lies more in its usefulness than in its truth. Being able to predict the shape of a molecule is important. In many cases all the theories give the correct answer.

### THE LEWIS THEORY

#### The octet rule

The Lewis theory was the first explanation of a covalent bond in terms of electrons that was generally accepted. If two electrons are shared between two atoms, this constitutes a bond and binds the atoms together. For many light atoms a stable arrangement is attained when the atom is surrounded by eight electrons. This octet can be made up from some electrons which are 'totally owned' and some electrons which are 'shared'. Thus atoms continue to form bonds until they have made up an octet of electrons. This is called the 'octet rule'. The octet rule explains the observed valencies in a large number of cases. There are exceptions to the octet rule; for example, hydrogen is stable with only two electrons. Other exceptions are discussed later. A chlorine atom has seven electrons in its outer shell, so by sharing one electron with another chlorine atom both atoms attain an octet and form a chlorine molecule  $\text{Cl}_2$ .

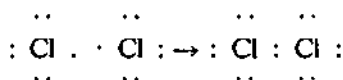

A carbon atom has four electrons in its outer shell, and by sharing all four electrons and forming four bonds it attains octet status in  $\text{CCl}_4$ .

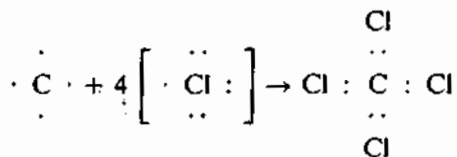

In a similar way, a nitrogen atom has five outer electrons, and in  $\text{NH}_3$  it shares three of these, forming three bonds and thus attaining an octet. Hydrogen has only one electron, and by sharing it attains a stable arrangement of two electrons.

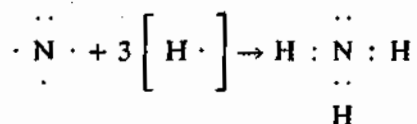

In a similar way an atom of oxygen attains an octet by sharing two electrons in  $\text{H}_2\text{O}$  and an atom of fluorine attains an octet by sharing one electron in  $\text{HF}$ .

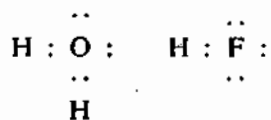

Double bonds are explained by sharing four electrons between two atoms, and triple bonds by sharing six electrons.

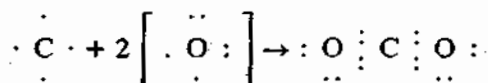

#### Exceptions to the octet rule

The octet rule is broken in a significant number of cases:

1. For example, for atoms such as Be and B which have less than four outer electrons. Even if all the outer electrons are used to form bonds an octet cannot be attained.

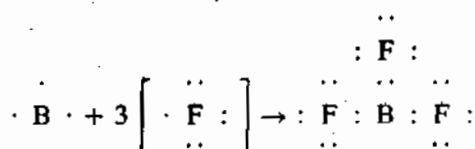
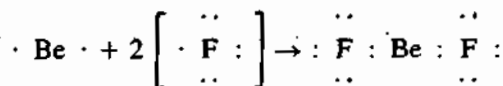

2. The octet rule is also broken where atoms have an extra energy level which is close in energy to the  $p$  level, and may accept electrons and be

used for bonding.  $\text{PF}_3$  obeys the octet rule, but  $\text{PF}_5$  does not.  $\text{PF}_5$  has ten outer electrons, and uses one  $3s$ , three  $3p$  and one  $3d$  orbitals. Any compound with more than four covalent bonds must break the octet rule, and these violations become increasingly common in elements after the first two periods of eight elements in the periodic table.

3. The octet rule does not work in molecules which have an odd number of electrons, such as  $\text{NO}$  and  $\text{ClO}_2$ , nor does it explain why  $\text{O}_2$  is paramagnetic and has two unpaired electrons.

Despite these exceptions, the octet rule is surprisingly reliable and did a great deal to explain the number of bonds formed in simple cases. However, it gives no indication of the shape adopted by the molecule.

### SIDGWICK-POWELL THEORY

In 1940 Sidgwick and Powell (see Further Reading) reviewed the structures of molecules then known. They suggested that for molecules and ions that only contain single bonds, the approximate shape can be predicted from the number of electron pairs in the outer or valence shell of the central atom. The outer shell contains one or more bond pairs of electrons, but it may also contain unshared pairs of electrons (lone pairs). Bond pairs and lone pairs were taken as equivalent, since all electron pairs take up some space, and since all electron pairs repel each other. Repulsion is minimized if the electron pairs are orientated in space as far apart as possible.







1. If there are two pairs of electrons in the valence shell of the central atom, the orbitals containing them will be oriented at  $180^\circ$  to each other. It follows that if these orbitals overlap with orbitals from other atoms to form bonds, then the molecule formed will be linear.
2. If there are three electron pairs on the central atom, they will be at  $120^\circ$  to each other, giving a plane triangular structure.
3. For four electron pairs the angle is  $109^\circ 28'$ , and the shape is tetrahedral.
4. For five pairs, the shape is a trigonal bipyramid.
5. For six pairs the angles are  $90^\circ$  and the shape is octahedral.

### VALENCE SHELL ELECTRON PAIR REPULSION (VSEPR) THEORY

In 1957 Gillespie and Nyholm (see Further Reading) improved the Sidgwick-Powell theory to predict and explain molecular shapes and bond angles more exactly. The theory was developed extensively by Gillespie as the Valence Shell Electron Pair Repulsion (VSEPR) theory. This may be summarized:

1. The shape of the molecule is determined by repulsions between all of the electron pairs present in the valence shell. (This is the same as the Sidgwick-Powell theory.)

Table 4.1 Molecular shapes predicted by Sidgwick-Powell theory

Number of electron pairs in outer shell	Shape of molecule	Bond angles
2	linear 	180°
3	plane triangle 	120°
4	tetrahedron 	109°28'
5	trigonal bipyramid 	120° and 90°
6	octahedron 	90°
7	pentagonal bipyramid 	72° and 90°

- A lone pair of electrons takes up more space round the central atom than a bond pair, since the lone pair is attracted to one nucleus whilst the bond pair is shared by two nuclei. It follows that repulsion between two lone pairs is greater than repulsion between a lone pair and a bond pair, which in turn is greater than the repulsion between two bond pairs. Thus the presence of lone pairs on the central atom causes slight distortion of the bond angles from the ideal shape. If the angle between a lone pair, the central atom and a bond pair is increased, it follows that the actual bond angles between the atoms must be decreased.
- The magnitude of repulsions between bonding pairs of electrons depends on the electronegativity difference between the central atom and the other atoms.
- Double bonds cause more repulsion than single bonds, and triple bonds cause more repulsion than a double bond.

#### Effect of lone pairs

Molecules with four electron pairs in their outer shell are based on a tetrahedron. In  $\text{CH}_4$  there are four bonding pairs of electrons in the outer shell of the C atom, and the structure is a regular tetrahedron with bond angles  $\text{H}-\text{C}-\text{H}$  of  $109^\circ 28'$ . In  $\text{NH}_3$ , the N atom has four electron pairs in the outer shell, made up of three bond pairs and one lone pair. Because of the lone pair, the bond angle  $\text{H}-\text{N}-\text{H}$  is reduced from the theoretical tetrahedral angle of  $109^\circ 28'$  to  $107^\circ 48'$ . In  $\text{H}_2\text{O}$  the O atom has four electron pairs in the outer shell. The shape of the  $\text{H}_2\text{O}$  molecule is based on a tetrahedron with two corners occupied by bond pairs and the other two corners occupied by lone pairs. The presence of two lone pairs reduces the bond angle further to  $104^\circ 27'$ .

In a similar way  $\text{SF}_6$  has six bond pairs in the outer shell and is a regular octahedron with bond angles of exactly  $90^\circ$ . In  $\text{BrF}_5$  the Br also has six outer pairs of electrons, made up of five bond pairs and one lone pair. The

lone pair reduces the bond angles to  $84^{\circ}30'$ . Whilst it might be expected that two lone pairs would distort the bond angles in an octahedron still further, in  $\text{XeF}_4$  the angles are  $90^{\circ}$ . This is because the lone pairs are *trans* to each other in the octahedron, and hence the atoms have a regular square planar arrangement.

Molecules with five pairs of electrons are all based on a trigonal bipyramid. Lone pairs distort the structures as before. The lone pairs always occupy the equatorial positions (in the triangle), rather than the apical positions (up and down). Thus in the  $\text{I}_3^-$  ion the central I atom has five electron pairs in the outer shell, made of two bond pairs and three lone pairs. The lone pairs occupy all three equatorial positions and the three atoms occupy the top, middle, and bottom positions in the trigonal bipyramid, thus giving a linear arrangement with a bond angle of exactly  $180^{\circ}$  (Table 4.2).

#### Effect of electronegativity

$\text{NF}_3$  and  $\text{NH}_3$  both have structures based on a tetrahedron with one corner occupied by a lone pair. The high electronegativity of F pulls the bonding electrons further away from N than in  $\text{NH}_3$ . Thus repulsion between bond pairs is less in  $\text{NF}_3$  than in  $\text{NH}_3$ . Hence the lone pair in  $\text{NF}_3$  causes a greater distortion from tetrahedral and gives a F—N—F bond angle of  $102^{\circ}30'$ , compared with  $107^{\circ}48'$  in  $\text{NH}_3$ . The same effect is found in  $\text{H}_2\text{O}$  (bond angle  $104^{\circ}27'$ ) and  $\text{F}_2\text{O}$  (bond angle  $102^{\circ}$ ).

Table 4.2 The effects of bonding and lone pairs on bond angles

	Orbitals on central atom	Shape	Number of bond pairs	Number of lone pairs	Bond angle
$\text{BeCl}_2$	2	Linear	2	0	$180^{\circ}$
$\text{BF}_3$	3	Plane triangle	3	0	$120^{\circ}$
$\text{CH}_4$	4	Tetrahedral	4	0	$109^{\circ}28'$
$\text{NH}_3$	4	Tetrahedral	3	1	$107^{\circ}48'$
$\text{NF}_3$	4	Tetrahedral	3	1	$102^{\circ}30'$
$\text{H}_2\text{O}$	4	Tetrahedral	2	2	$104^{\circ}27'$
$\text{F}_2\text{O}$	4	Tetrahedral	2	2	$102^{\circ}$
$\text{PCl}_5$	5	Trigonal bipyramid	5	0	$120^{\circ}$ and $90^{\circ}$
$\text{SF}_4$	5	Trigonal bipyramid	4	1	$101^{\circ}36'$ and $86^{\circ}33'$
$\text{ClF}_3$	5	Trigonal bipyramid	3	2	$87^{\circ}40'$
$\text{I}_3^-$	5	Trigonal bipyramid	2	3	$180^{\circ}$
$\text{SF}_6$	6	Octahedral	6	0	$90^{\circ}$
$\text{BrF}_5$	6	Octahedral	5	1	$84^{\circ}30'$
$\text{XeF}_4$	6	Octahedral	4	2	$90^{\circ}$

**Isoelectronic principle**

Isoelectronic species usually have the same structure. This may be extended to species with the same number of valence electrons. Thus  $\text{BF}_4^-$ ,  $\text{CH}_4$  and  $\text{NH}_4^+$  are all tetrahedral,  $\text{CO}_3^{2-}$ ,  $\text{NO}_3^-$  and  $\text{SO}_3$  are all planar triangles, and  $\text{CO}_2$ ,  $\text{N}_3^-$  and  $\text{NO}_2^+$  are all linear.

**SOME EXAMPLES USING THE VSEPR THEORY** **$\text{BF}_3$  and the  $[\text{BF}_4]^-$  ion**

Consider  $\text{BF}_3$  first. The VSEPR theory only requires the number of electron pairs in the outer shell of the central atom. Since B is in Group III it has three electrons in the outer shell. (Alternatively the electronic structure of B (the central atom), is  $1s^2 2s^2 2p^1$ , so there are three electrons in the outer valence shell.) If all three outer electrons are used to form bonds to three F atoms, the outer shell then has a share in six electrons, that is three electron pairs. Thus the structure is a planar triangle.

The  $[\text{BF}_4]^-$  ion may be regarded as being formed by adding a  $\text{F}^-$  ion to a  $\text{BF}_3$  molecule by means of a coordinate bond. Thus the B atom now has three electron pairs from the  $\text{BF}_3$  plus one electron pair from the  $\text{F}^-$ . There are therefore four electron pairs in the outer shell: hence the  $\text{BF}_4^-$  ion has a tetrahedral structure.

**Ammonia  $\text{NH}_3$** 

N is the central atom. It is in Group V and has five electrons in the outer valence shell. (The electronic structure of N is  $1s^2 2s^2 2p^3$ .) Three of these electrons are used to form bonds to three H atoms, and two electrons take no part in bonding and constitute a 'lone pair'. The outer shell then has a share in eight electrons, that is three bond pairs of electrons and one lone pair. Four electron pairs give rise to a tetrahedral structure and in this case three positions are occupied by H atoms and the fourth position is occupied by the lone pair (Figure 4.1). The shape of  $\text{NH}_3$  may either be described as tetrahedral with one corner occupied by a lone pair, or alternatively as pyramidal. The presence of the lone pair causes slight distortion from  $109^\circ 28'$  to  $107^\circ 48'$ .

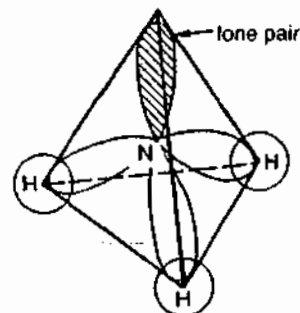
Figure 4.1 Structure of  $\text{NH}_3$ .**Water  $\text{H}_2\text{O}$** 

O is the central atom. It is in Group VI and hence has six outer electrons. (The electronic structure of O is  $1s^2 2s^2 2p^4$ .) Two of these electrons form bonds with two H atoms, thus completing the octet. The other four outer electrons on O are non-bonding. Thus in  $\text{H}_2\text{O}$  the O atom has eight outer electrons (four electron pairs) so the structure is based on a tetrahedron. There are two bond pairs and two lone pairs. The structure is described as tetrahedral with two positions occupied by lone pairs. The two lone pairs distort the bond angle from  $109^\circ 28'$  to  $104^\circ 27'$  (Figure 4.2).

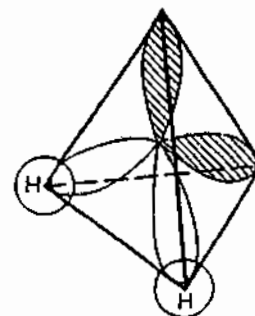
Figure 4.2 Structure of  $\text{H}_2\text{O}$ .

Any triatomic molecule must be either linear with a bond angle of  $180^\circ$ , or else angular, that is bent. In  $\text{H}_2\text{O}$  the molecule is based on a tetrahedron, and is therefore bent.

#### Phosphorus pentachloride $\text{PCl}_5$

Gaseous  $\text{PCl}_5$  is covalent. P (the central atom) is in Group V and so has five electrons in the outer shell. (The electronic structure of P is  $1s^2 2s^2 2p^6 3s^2 3p^3$ .) All five outer electrons are used to form bonds to the five Cl atoms. In the  $\text{PCl}_5$  molecule the valence shell of the P atom contains five electron pairs: hence the structure is a trigonal bipyramid. There are no lone pairs, so the structure is not distorted. However, a trigonal bipyramid is not a completely regular structure, since some bond angles are  $90^\circ$  and others  $120^\circ$ . Symmetrical structures are usually more stable than asymmetrical ones. Thus  $\text{PCl}_5$  is highly reactive, and in the solid state it splits into  $[\text{PCl}_4]^+$  and  $[\text{PCl}_6]^-$  ions, which have tetrahedral and octahedral structures respectively.

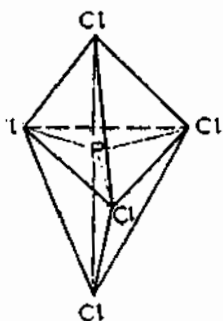

4.3 Structure of  $\text{PCl}_5$  le.

#### Chlorine trifluoride $\text{ClF}_3$

The chlorine atom is at the centre of the molecule and determines its shape. Cl is in Group VII and so has seven outer electrons. (The electronic structure of Cl is  $1s^2 2s^2 2p^6 3s^2 3p^5$ .) Three electrons form bonds to F, and four electrons do not take part in bonding. Thus in  $\text{ClF}_3$  the Cl atom has five electron pairs in the outer shell: hence the structure is a trigonal bipyramid. There are three bond pairs and two lone pairs.

It was noted previously that a trigonal bipyramid is not a regular shape since the bond angles are not all the same. It therefore follows that the corners are not equivalent. Lone pairs occupy two of the corners, and F atoms occupy the other three corners. Three different arrangements are theoretically possible, as shown in Figure 4.4.

The most stable structure will be the one of lowest energy, that is the one with the minimum repulsion between the five orbitals. The greatest repulsion occurs between two lone pairs. Lone pair-bond pair repulsions are next strongest, and bond pair-bond pair repulsions the weakest.

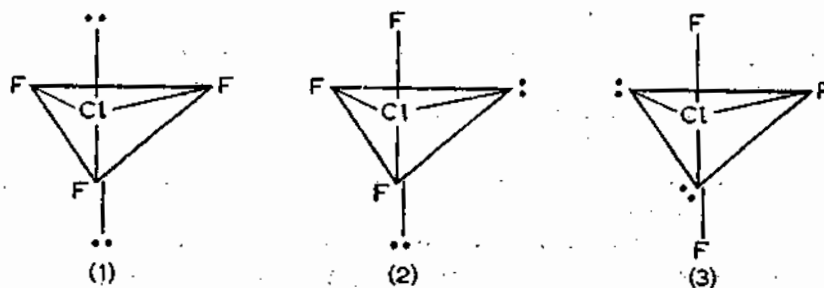

Figure 4.4 Chlorine trifluoride molecule.



Groups at  $90^\circ$  to each other repel each other strongly, whilst groups  $120^\circ$  apart repel each other much less.

Structure 1 is the most symmetrical, but has six  $90^\circ$  repulsions between lone pairs and atoms. Structure 2 has one  $90^\circ$  repulsion between two lone pairs, plus three  $90^\circ$  repulsions between lone pairs and atoms. Structure 3 has four  $90^\circ$  repulsions between lone pairs and atoms. These factors indicate that structure 3 is the most probable. The observed bond angles are  $87^\circ 40'$ , which is close to the theoretical  $90^\circ$ . This confirms that the correct structure is (3), and the slight distortion from  $90^\circ$  is caused by the presence of the two lone pairs.

As a general rule, if lone pairs occur in a trigonal bipyramid they will be located in the equatorial positions (round the middle) rather than the apical positions (top and bottom), since this arrangement minimizes repulsive forces.

#### Sulphur tetrafluoride $\text{SF}_4$

S is in Group VI and thus has six outer electrons. (The electronic configuration of S is  $1s^2 2s^2 2p^6 3s^2 3p^4$ .) Four outer electrons are used to form bonds with the F atoms, and two electrons are non-bonding. Thus in  $\text{SF}_4$  the S has five electron pairs in the outer shell: hence the structure is based on a trigonal bipyramid. There are four bond pairs and one lone pair. To minimize the repulsive forces the lone pair occupies an equatorial position, and F atoms are located at the other four corners, as shown in Figure 4.5.

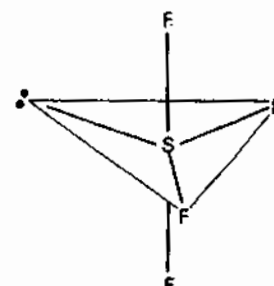
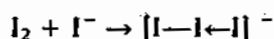

Figure 4.5 Sulphur tetrafluoride molecule.

#### The triiodide ion $\text{I}_3^-$

If iodine is dissolved in aqueous potassium iodide, the triiodide ion  $\text{I}_3^-$  is formed. This is an example of a polyhalide ion, which is similar in structure to  $\text{BrCl}_2^-$  (see Chapter 15). The  $\text{I}_3^-$  ion (Figure 4.6) has three atoms, and must be either linear or angular in shape. It is convenient to consider the structure in a series of stages – first an I atom, then an  $\text{I}_2$  molecule, and then the  $\text{I}_3^-$  ion made up of an  $\text{I}_2$  molecule with an  $\text{I}^-$  bonded to it by means of a coordinate bond.



Iodine is in Group VII and so has seven outer electrons. (The electronic configuration of I is  $1s^2 2s^2 2p^6 3s^2 3p^6 3d^{10} 4s^2 4p^6 4d^{10} 5s^2 5p^5$ .) One of the outer electrons is used to bond with another I atom, thus forming an  $\text{I}_2$  molecule. The I atoms now have a share in eight electrons. One of the I atoms in the  $\text{I}_2$  molecule accepts a lone pair from an  $\text{I}^-$  ion, thus forming an  $\text{I}_3^-$  ion. The outer shell of the central I atom now contains ten electrons, that is five electron pairs. Thus the shape is based on a trigonal bipyramid. There are two bond pairs and three lone pairs. To minimize the repulsive forces the three lone pairs occupy the equatorial positions, and I atoms are located at the centre and in the two apical positions. The ion is therefore linear in shape, with a bond angle of exactly  $180^\circ$ .

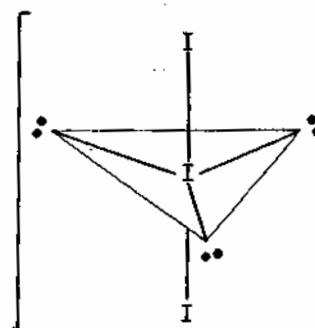
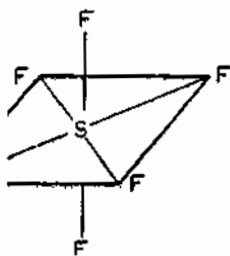

Figure 4.6 The triiodide ion.



Sulphur hexafluoride

**Sulphur hexafluoride SF<sub>6</sub>**

Sulphur is in Group VI and thus has six outer electrons. (The electronic structure of S is  $1s^2 2s^2 2p^6 3s^2 3p^4$ .) All six of the outer electrons are used to form bonds with the F atoms. Thus in SF<sub>6</sub> the S has six electron pairs in the outer shell: hence the structure is octahedral. There are no lone pairs so the structure is completely regular with bond angles of 90°.

**Iodine heptafluoride IF<sub>7</sub>**

This is the only common example of a non-transition element using seven orbitals for bonding giving a pentagonal bipyramid. (See Chapter 15).

The total numbers of outer orbitals, bonding orbitals and lone pairs are related to the commonly occurring shapes of molecules in Table 4.4.

**VALENCE BOND THEORY**

This theory was proposed by Linus Pauling, who was awarded the Nobel Prize for Chemistry in 1954. The theory was very widely used in the period 1940–1960. Since then it has to some extent fallen out of fashion. However, it is still much used by organic chemists, and it provides a basis for simple description of small inorganic molecules.

Atoms with unpaired electrons tend to combine with other atoms which also have unpaired electrons. In this way the unpaired electrons are paired up, and the atoms involved all attain a stable electronic arrangement. This is usually a full shell of electrons (i.e. a noble gas configuration). Two electrons shared between two atoms constitute a bond. The number of bonds formed by an atom is usually the same as the number of unpaired electrons in the ground state, i.e. the lowest energy state. However, in some cases the atom may form more bonds than this. This occurs by excitation of the atom (i.e. providing it with energy) when electrons which were paired in the ground state are unpaired and promoted into suitable empty orbitals. This increases the number of unpaired electrons, and hence the number of bonds which can be formed.

The shape of the molecule is determined primarily by the directions in which the orbitals point. Electrons in the valence shell of the original atom which are paired are called lone pairs.

A covalent bond results from the pairing of electrons (one from each atom). The spins of the two electrons must be opposite (antiparallel) because of the Pauli exclusion principle that no two electrons in one atom can have all four quantum numbers the same.

Consider the formation of a few simple molecules.

1. In HF, H has a singly occupied *s* orbital that overlaps with a singly filled *2p* orbital on F.
2. In H<sub>2</sub>O, the O atom has two singly filled *2p* orbitals, each of which overlaps with a singly occupied *s* orbital from two H atoms.

3. In  $\text{NH}_3$ , there are three singly occupied  $p$  orbitals on N which overlap with  $s$  orbitals from three H atoms.
4. In  $\text{CH}_4$ , the C atom in its ground state has the electronic configuration  $1s^2, 2s^2, 2p_x^1, 2p_y^1$  and only has two unpaired electrons, and so can form only two bonds. If the C atom is excited, then the  $2s$  electrons may be unpaired giving  $1s^2, 2s^1, 2p_x^1, 2p_y^1, 2p_z^1$ . There are now four unpaired electrons which overlap with singly occupied  $s$  orbitals on four H atoms.

	1s	2s	2p
			$2p_x \quad 2p_y \quad 2p_z$
Electronic structure of carbon atom – ground state	↑↓	↑↓	↑ ↑
Carbon atom – excited state	↑↓	↑	↑ ↑ ↑
Carbon atom having gained four electrons from H atoms in $\text{CH}_4$ molecule	↑↓	↑↓	↑↓ ↑↓ ↑↓

The shape of the  $\text{CH}_4$  molecule is not immediately apparent. The three  $p$  orbitals  $p_x, p_y$  and  $p_z$  are mutually at right angles to each other, and the  $s$  orbital is spherically symmetrical. If the  $p$  orbitals were used for bonding then the bond angle in water should be  $90^\circ$ , and the bond angles in  $\text{NH}_3$  should also be  $90^\circ$ . The bond angles actually found differ appreciably from these:

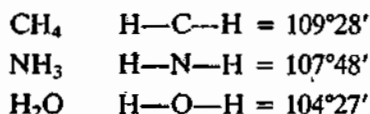

### Hybridization

The chemical and physical evidence indicates that in methane  $\text{CH}_4$  there are four equivalent bonds. If they are equivalent, then repulsion between electron pairs will be a minimum if the four orbitals point to the corners of a tetrahedron, which would give the observed bond angle of  $109^\circ 28'$ .

Each electron can be described by its wave function  $\psi$ . If the wave functions of the four outer atomic orbitals of C are  $\psi_{2s}, \psi_{2p_x}, \psi_{2p_y}$ , and  $\psi_{2p_z}$ , then the tetrahedrally distributed orbitals will have wave functions  $\psi_{sp^3}$  made up from a linear combination of these four atomic wave functions.

$$\psi_{sp^3} = c_1\psi_{2s} + c_2\psi_{2p_x} + c_3\psi_{2p_y} + c_4\psi_{2p_z}$$

There are four different combinations with different weighting constants  $c_1, c_2, c_3$  and  $c_4$ .

$$\begin{aligned} \psi_{sp^3(1)} &= \frac{1}{2}\psi_{2s} + \frac{1}{2}\psi_{2p_x} + \frac{1}{2}\psi_{2p_y} + \frac{1}{2}\psi_{2p_z} \\ \psi_{sp^3(2)} &= \frac{1}{2}\psi_{2s} + \frac{1}{2}\psi_{2p_x} - \frac{1}{2}\psi_{2p_y} - \frac{1}{2}\psi_{2p_z} \end{aligned}$$

$$\psi_{sp^3(3)} = \frac{1}{2}\psi_{2s} - \frac{1}{2}\psi_{2p_x} + \frac{1}{2}\psi_{2p_y} - \frac{1}{2}\psi_{2p_z}$$

$$\psi_{sp^3(4)} = \frac{1}{2}\psi_{2s} - \frac{1}{2}\psi_{2p_x} - \frac{1}{2}\psi_{2p_y} + \frac{1}{2}\psi_{2p_z}$$

Combining or mixing the wave functions for the atomic orbitals in this way is called hybridization. Mixing one  $s$  and three  $p$  orbitals in this way gives four  $sp^3$  hybrid orbitals. The shape of an  $sp^3$  orbital is shown in Figure 4.8. Since one lobe is enlarged, it can overlap more effectively than an  $s$  orbital or a  $p$  orbital on its own. Thus  $sp^3$  hybrid orbitals form stronger bonds than the original atomic orbitals. (See Table 4.3.)

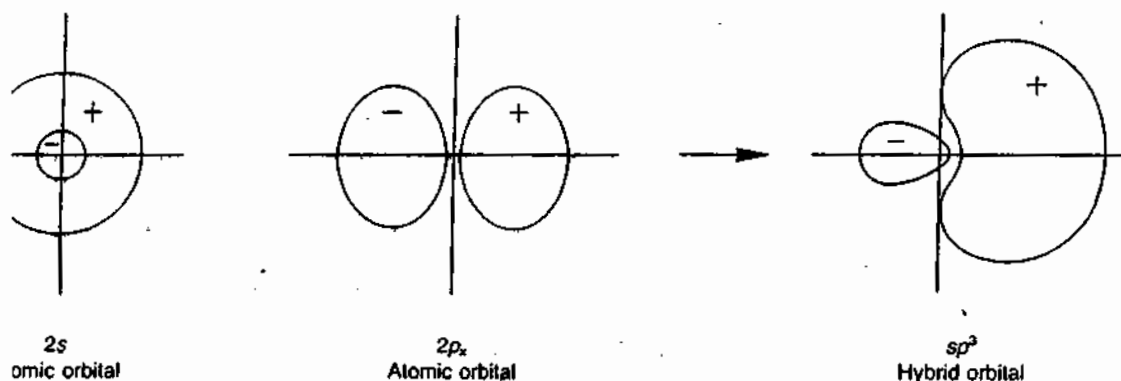
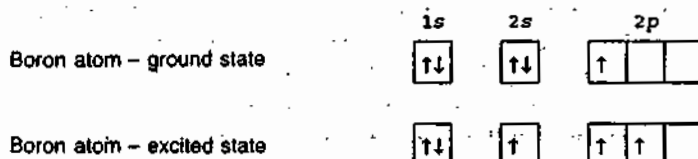

Figure 4.8 Combination of  $s$  and  $p$  atomic orbitals to give an  $sp^3$  hybrid orbital: (a)  $2s$  atomic orbital, (b)  $2p_x$  atomic orbital and (c)  $sp^3$  hybrid orbital.

Table 4.3 Approximate strengths of bonds formed by various orbitals

Orbital	Relative bond strength
$s$	1.0
$p$	1.73
$sp$	1.93
$sp^2$	1.99
$sp^3$	2.00

It is possible to mix other combinations of atomic orbitals in a similar way. The structure of a boron trifluoride  $BF_3$  molecule is a planar triangle with bond angles of  $120^\circ$ . The B atom is the central atom in the molecule, and it must be excited to give three unpaired electrons so that it can form three covalent bonds.



BF<sub>3</sub> molecule having gained a share in three electrons by bonding to three F atoms



$sp^2$  hybridization of the three orbitals in outer shell, hence structure is a planar triangle

Combining the wave functions of the  $2s$ ,  $2p_x$  and  $2p_y$  atomic orbitals gives three hybrid  $sp^2$  orbitals.

$$\psi_{sp^2(1)} = \frac{1}{\sqrt{3}} \psi_{2s} + \frac{2}{\sqrt{6}} \psi_{2p_x}$$

$$\psi_{sp^2(2)} = \frac{1}{\sqrt{3}} \psi_{2s} + \frac{1}{\sqrt{6}} \psi_{2p_x} + \frac{1}{\sqrt{2}} \psi_{2p_y}$$

$$\psi_{sp^2(3)} = \frac{1}{\sqrt{3}} \psi_{2s} + \frac{1}{\sqrt{6}} \psi_{2p_x} - \frac{1}{\sqrt{2}} \psi_{2p_y}$$

These three orbitals are equivalent, and repulsion between them is minimized if they are distributed at  $120^\circ$  to each other giving a planar triangle. In the hybrid orbitals one lobe is bigger than the other, so it can overlap more effectively and hence form a stronger bond than the original atomic orbitals. (See Table 4.3.) Overlap of the  $sp^2$  orbitals with  $p$  orbitals from F atoms gives the planar triangular molecule BF<sub>3</sub> with bond angles of  $120^\circ$ .

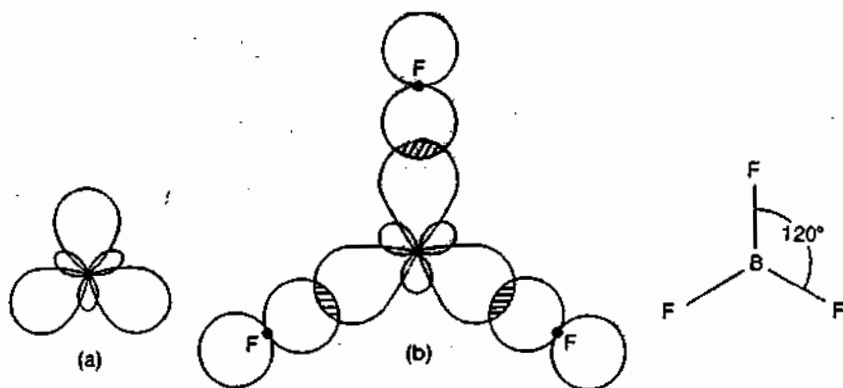

Figure 4.9 (a)  $sp^2$  hybrid orbitals and (b) the BF<sub>3</sub> molecule.

The structure of a gaseous molecule of beryllium fluoride BeF<sub>2</sub> is linear F—Be—F. Be is the central atom in this molecule and determines the shape of the molecule formed. The ground state electronic configuration of Be is  $1s^2 2s^2$ . This has no unpaired electrons, and so can form no bonds. If energy is supplied, an excited state will be formed by unpairing and promoting a  $2s$  electron to an empty  $2p$  level, giving  $1s^2 2s^1 2p^1$ . There are now two unpaired electrons, so the atom can form the required two bonds.

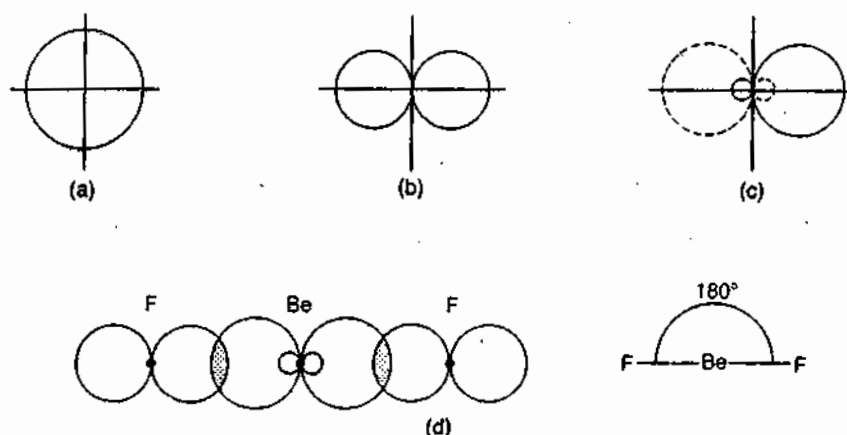
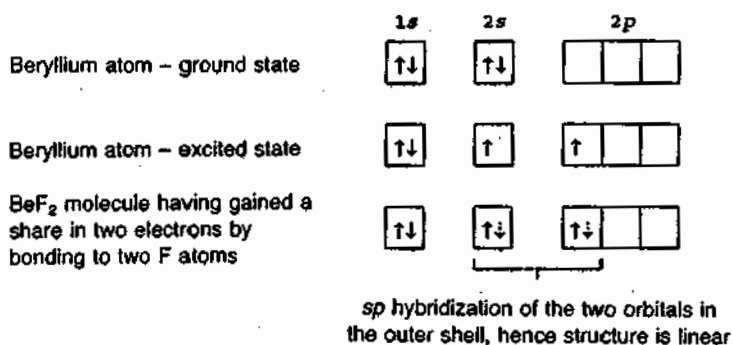

Figure 4.10 (a) *s* orbital, (b) *p* orbital, (c) formation of two *sp* hybrid orbitals and (d) their use in forming beryllium difluoride.



Hybridizing the 2*s* and 2*p<sub>x</sub>* atomic orbitals gives two equivalent *sp* hybrid orbitals.

$$\psi_{sp(1)} = \frac{1}{\sqrt{2}} \psi_{2s} + \frac{1}{\sqrt{2}} \psi_{2p_x}$$

$$\psi_{sp(2)} = \frac{1}{\sqrt{2}} \psi_{2s} - \frac{1}{\sqrt{2}} \psi_{2p_x}$$

Because of their shape these *sp* orbitals overlap more effectively and result in stronger bonds than the original atomic orbitals. Repulsion is minimized if these two hybrid orbitals are oriented at 180° to each other. If these orbitals overlap with *p* orbitals on F atoms, a linear BeF<sub>2</sub> molecule is obtained.

It should in principle be possible to calculate the relative strength of bonds formed using *s*, *p* or various hybrid orbitals. However, the wave equation can only be solved exactly for atoms containing one electron, that is hydrogen-like species H, He<sup>+</sup>, Li<sup>2+</sup>, Be<sup>3+</sup> etc. Attempts to work out the relative bond strengths involve approximations, which may or may not be valid. On this basis it has been suggested that the relative strengths of

Table 4.4 Number of orbitals and type of hybridization

Number of outer orbitals	Type of hybridization	Distribution in space of hybrid orbitals
2	$sp$	Linear
3	$sp^2$	Plane triangle
4	$sp^3$	Tetrahedron
5	$sp^3d$	Trigonal bipyramid
6	$sp^3d^2$	Octahedron
7	$sp^3d^3$	Pentagonal bipyramid
(4)	$dsp^2$	Square planar

bonds using *s*, *p* and various hybrid atomic orbitals may be as shown in Table 4.3.

Hybridization and the mixing of orbitals is a most useful concept. Mixing of *s* and *p* orbitals is well accepted, but the involvement of *d* orbitals is controversial. For effective mixing, the energy of the orbitals must be nearly the same.

It is a common misconception that hybridization is the cause of a particular molecular shape. This is not so. The reason why any particular shape is adopted is its energy. It is also important to remember that the hybridized state is a theoretical step in going from an atom to a molecule, and the hybridized state never actually exists. It cannot be detected even spectroscopically, so the energy of hybrid orbitals cannot be measured and can only be estimated theoretically.

### THE EXTENT OF *d* ORBITAL PARTICIPATION IN MOLECULAR BONDING

The bonding in  $\text{PCl}_5$  may be described using hybrids of the  $3s$ ,  $3p$  and  $3d$  atomic orbitals for P – see below. However, there are doubts as to whether *d* orbitals can take part and this has led to the decline of this theory.

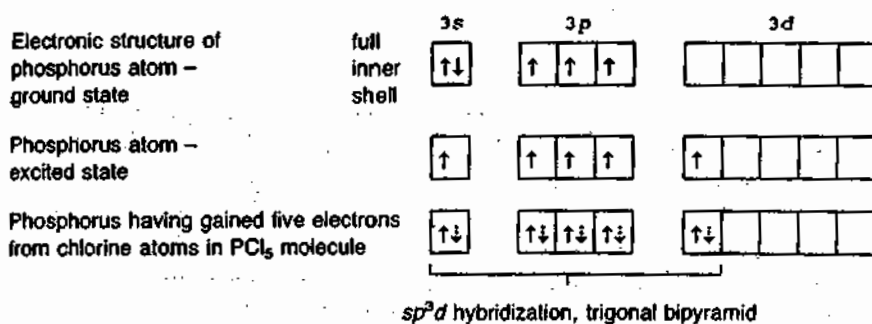

However, *d* orbitals are in general too large and too high in energy to mix completely with *s* and *p* orbitals. The difference in size is illustrated by

the mean values for the radial distance for different phosphorus orbitals:  $3s = 0.47 \text{ \AA}$ ,  $3p = 0.55 \text{ \AA}$  and  $3d = 2.4 \text{ \AA}$ . The energy of an orbital is proportional to its mean radial distance, and since the  $3d$  orbital is much larger it is much higher in energy than the  $3s$  and  $3p$  orbitals. It would at first seem unlikely that hybridization involving  $s$ ,  $p$  and  $d$  orbitals could possibly occur.

Several factors affect the size of orbitals. The most important is the charge on the atom. If the atom carries a formal positive charge then all the electrons will be pulled in towards the nucleus. The effect is greatest for the outer electrons. If the central P atom is bonded to a highly electronegative element such as F, O or Cl, then the electronegative element attracts more than its share of the bonding electrons and the F or Cl atom attains a  $\delta^-$  charge. This leaves a  $\delta^+$  charge on P, which makes the orbitals contract. Since the  $3d$  orbital contracts in size very much more than the  $3s$  and  $3p$  orbitals, the energies of the  $3s$ ,  $3p$  and  $3d$  orbitals may become close enough to allow hybridization to occur in  $\text{PCl}_5$ . Hydrogen does not cause this large contraction, so  $\text{PH}_5$  does not exist.

In a similar way the structure of  $\text{SF}_6$  can be described by mixing the  $3s$ , three  $3p$  and two  $3d$  orbitals, that is  $sp^3d^2$  hybridization.

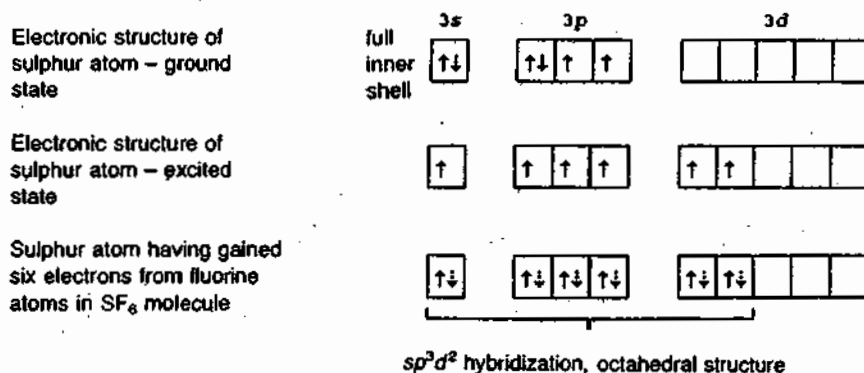

The presence of six highly electronegative F atoms causes a large contraction of the  $d$  orbitals, and lowers their energy, so mixing may be possible.

A second factor affecting the size of  $d$  orbitals is the number of  $d$  orbitals occupied by electrons. If only one  $3d$  orbital is occupied on an S atom, the

Table 4.5 Sizes of orbitals

$(sp^3d^2$ configuration)	Mean radial distance ( $\text{Å}$ )		
	$3s$	$3p$	$3d$
S atom (neutral, no charge)	0.88	0.94	1.60
S atom (charge +0.6)	0.87	0.93	1.40



average radial distance is 2.46 Å, but when two 3*d* orbitals are occupied the distance drops to 1.60 Å. The effect of changing the charge can be seen in Table 4.5.

A further small contraction of *d* orbitals may arise by coupling of the spins of electrons occupying different orbitals.

It seems probable that *d* orbitals do participate in bonding in cases where *d* orbital contraction occurs.

### SIGMA AND PI BONDS

All the bonds formed in these examples result from end to end overlap of orbitals and are called sigma σ bonds. In σ bonds the electron density is concentrated in between the two atoms, and on a line joining the two atoms. Double or triple bonds occur by the sideways overlap of orbitals, giving pi π bonds. In π bonds the electron density also concentrates between the atoms, but on either side of the line joining the atoms. The shape of the molecule is determined by the σ bonds (and lone pairs) but not by the π bonds. Pi bonds merely shorten the bond lengths.

Consider the structure of the carbon dioxide molecule. Since C is typically four-valent and O is typically two-valent, the bonding can be simply represented

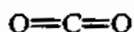

Triatomic molecules must be either linear or angular. In CO<sub>2</sub>, the C atom must be excited to provide four unpaired electrons to form the four bonds required.

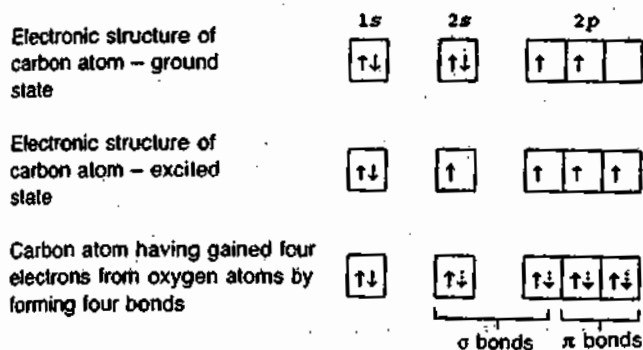

There are two σ bonds and two π bonds in the molecule. Pi orbitals are ignored in determining the shape of the molecule. The remaining *s* and *p* orbitals are used to form the σ bonds. (These could be hybridized and the two *sp*<sup>2</sup> orbitals will point in opposite directions. Alternatively VSEPR theory suggests that these two orbitals will be oriented as far apart as possible.) These two orbitals overlap with *p* orbitals from two O atoms, forming a linear molecule with a bond angle of 180°. The 2*p*<sub>*y*</sub> and 2*p*<sub>*z*</sub> orbitals on C used for π bonding are at right angles to the bond, and

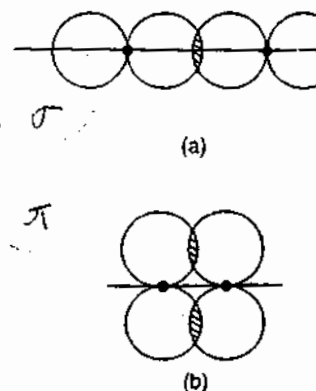
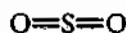

Figure 4.11 Sigma and pi overlap: (a) sigma overlap (lobes point along the nuclei); (b) pi overlap (lobes are at right angle to the line joining the nuclei).

overlap sideways with  $p$  orbitals on the O atoms at either side. This  $\pi$  overlap shortens the C—O distances, but does not affect the shape.

The sulphur dioxide molecule  $\text{SO}_2$  may be considered in a similar way. S shows oxidation states of (+II), (+IV) and (+VI), whilst O is two-valent. The structure may be represented:



Triatomic molecules are either linear or bent. The S atom must be excited to provide four unpaired electrons.

Electronic structure of sulphur atom – ground state

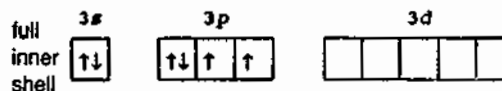

Electronic structure of sulphur atom – excited state



Sulphur atom having gained four electrons from four bonds to oxygen atoms in  $\text{SO}_2$  molecule

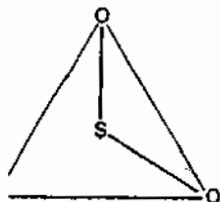
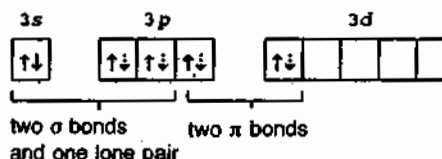

4.12 Sulphur dioxide e.

The two electron pairs which form the  $\pi$  bonds do not affect the shape of the molecule. The remaining three orbitals point to the corners of a triangle, and result in a planar triangular structure for the molecule with two corners occupied by O atoms and one corner occupied by a lone pair. The  $\text{SO}_2$  molecule is thus angular or V shaped (Figure 4.12).

The  $\pi$  bonds do not alter the shape, but merely shorten the bond lengths. The bond angle is reduced from the ideal value of  $120^\circ$  to  $119^\circ 30'$  because of the repulsion by the lone pair of electrons. Problems arise when we examine exactly which AOs are involved in  $\pi$  overlap. If the  $\sigma$  bonding occurs in the  $xy$  plane then  $\pi$  overlap can occur between the  $3p_z$  orbital on S and the  $2p_z$  orbital on one O atom to give one  $\pi$  bond. The second  $\pi$  bond involves a  $d$  orbital. Though the  $3d_{z^2}$  orbital on S is in the correct orientation for  $\pi$  overlap with the  $2p_z$  orbital on the other O atom, the symmetry of the  $3d_{z^2}$  orbital is wrong (both lobes have a + sign) whilst for a  $p$  orbital one lobe is + and the other -. Thus overlap of these orbitals does not result in bonding. The  $3d_{xz}$  orbital on S is in the correct orientation, and has the correct symmetry to overlap with the  $2p_z$  orbital on the second O atom, and could give the second  $\pi$  bond. It is surprising that  $\pi$  bonds involving  $p$  and  $d$  orbitals both have the same energy (and bond length). This calls into question whether it is correct to treat molecules with two  $\pi$  bonds as containing two discrete  $\pi$  bonds. A better approach is to treat the  $\pi$  bonds as being delocalized over several atoms. Examples of this treatment are given near the end of this chapter.

In the sulphur trioxide molecule  $\text{SO}_3$  valency requirements suggest the structure

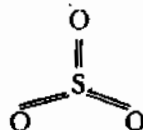

The central S atom must be excited to provide six unpaired electrons to form six bonds.

Electronic structure of sulphur atom – excited state

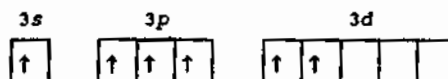

Sulphur atom having gained six electrons from six bonds to oxygen atoms in  $\text{SO}_3$  molecule

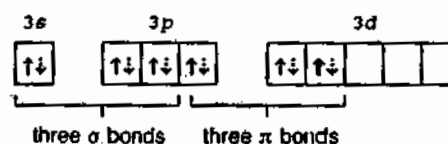

The three  $\pi$  bonds are ignored in determining the shape of the molecule. The three  $\sigma$  orbitals are directed towards the corners of an equilateral triangle, and the  $\text{SO}_3$  molecule is a completely regular plane triangle (Figure 4.13). The  $\pi$  bonds shorten the bond lengths, but do not affect the shape. This approach explains the  $\sigma$  bonding and shape of the molecule, but the explanation of  $\pi$  bonding is unsatisfactory. It presumes:

1. That one  $3p$  and two  $3d$  orbitals on S are in the correct orientation to overlap sideways with the  $2p_y$  or  $2p_z$  orbitals on three different O atoms; and
2. That the  $\pi$  bonds formed are all of equal strength.

This calls into question the treatment of  $\pi$  bonds. In molecules with more than one  $\pi$  bond, or molecules where the  $\pi$  bond could equally well exist in more than one position, it is better to treat the  $\pi$  bonding as being delocalized over several atoms rather than localized between two atoms. This approach is developed near the end of this chapter.

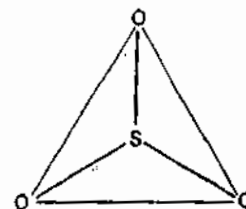

• Figure 4.13 Sulphur trioxide molecule.

## MOLECULAR ORBITAL METHOD

In the valence bond (electron pair) theory, a molecule is considered to be made up of atoms. Electrons in atoms occupy atomic orbitals. These may or may not be hybridized. If they are hybridized, atomic orbitals *from the same atom* combine to produce hybrid orbitals which can overlap more effectively with orbitals from other atoms, thus producing stronger bonds. Thus the atomic orbitals (or the hybrid orbitals) are thought to remain even when the atom is chemically bonded in a molecule.

In the molecular orbital theory, the valency electrons are considered to

be associated with all the nuclei in the molecule. Thus the atomic orbitals from different atoms must be combined to produce molecular orbitals.

Electrons may be considered either as particles or waves. An electron in an atom may therefore be described as occupying an atomic orbital, or by a wave function  $\psi$ , which is a solution to the Schrödinger wave equation. Electrons in a molecule are said to occupy molecular orbitals. The wave function describing a molecular orbital may be obtained by one of two procedures:

1. Linear combination of atomic orbitals (LCAO).
2. United atom method.

### LCAO METHOD

Consider two atoms A and B which have atomic orbitals described by the wave functions  $\psi_{(A)}$  and  $\psi_{(B)}$ . If the electron clouds of these two atoms overlap when the atoms approach, then the wave function for the molecule (molecular orbital  $\psi_{(AB)}$ ) can be obtained by a linear combination of the atomic orbitals  $\psi_{(A)}$  and  $\psi_{(B)}$ :

$$\psi_{(AB)} = N(c_1\psi_{(A)} + c_2\psi_{(B)})$$

where  $N$  is a normalizing constant chosen to ensure that the probability of finding an electron in the whole of the space is unity, and  $c_1$  and  $c_2$  are constants chosen to give a minimum energy for  $\psi_{(AB)}$ . If atoms A and B are similar, then  $c_1$  and  $c_2$  will have similar values. If atoms A and B are the same, then  $c_1$  and  $c_2$  are equal.

The probability of finding an electron in a volume of space  $dV$  is  $\psi^2 dV$ , so the probability density for the combination of two atoms as above is related to the wave function squared:

$$\psi_{(AB)}^2 = (c_1^2\psi_{(A)}^2 + 2c_1c_2\psi_{(A)}\psi_{(B)} + c_2^2\psi_{(B)}^2)$$

If we examine the three terms on the right of the equation, the first term  $c_1^2\psi_{(A)}^2$  is related to the probability of finding an electron on atom A if A is an isolated atom. The third term  $c_2^2\psi_{(B)}^2$  is related to the probability of finding an electron on atom B if B is an isolated atom. The middle term becomes increasingly important as the overlap between the two atom orbitals increases, and this term is called the overlap integral. This term represents the main difference between the electron clouds in individual atoms and in the molecule. The larger this term the stronger the bond.

### s - s combinations of orbitals

Suppose the atoms A and B are hydrogen atoms; then the wave functions  $\psi_{(A)}$  and  $\psi_{(B)}$  describe the 1s atomic orbitals on the two atoms. Two combinations of the wave functions  $\psi_{(A)}$  and  $\psi_{(B)}$  are possible:

1. Where the signs of the two wave functions are the same
2. Where the signs of the two wave functions are different.

(If one of the wave functions  $\psi_{(A)}$  is arbitrarily assigned a +ve sign, the other may be either +ve or -ve.) Wave functions which have the same sign may be regarded as waves that are in phase, which when combined add up to give a larger resultant wave. Similarly wave functions of different signs correspond to waves that are completely out of phase and which cancel each other by destructive interference. (The signs + and - refer to signs of the wave functions, which determine their symmetry, and have nothing to do with electrical charges.) The two combinations are:

$$\psi_{(g)} = N\{\psi_{(A)} + \psi_{(B)}\}$$

and

$$\psi_{(u)} = N\{\psi_{(A)} + [-\psi_{(B)}]\} \equiv N\{\psi_{(A)} - \psi_{(B)}\}$$

The latter equation should be regarded as the summation of the wave functions and *not* as the mathematical difference between them.

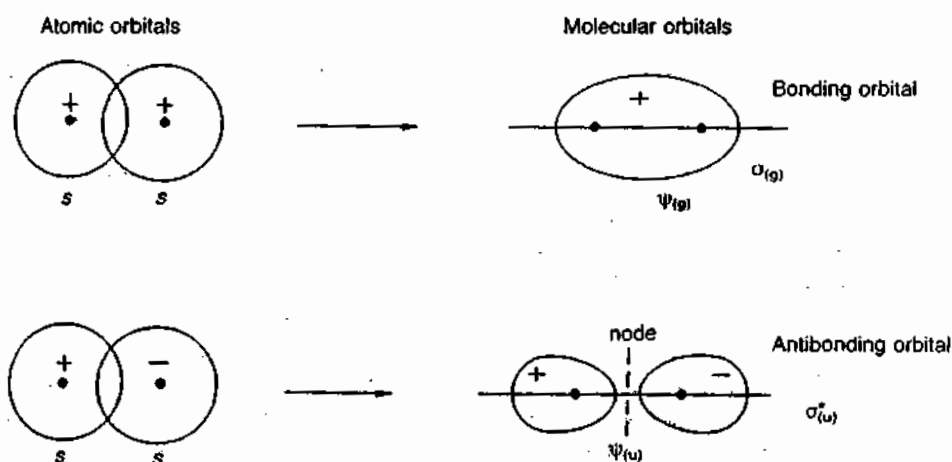

Figure 4.14 s-s combinations of atomic orbitals.

When a pair of atomic orbitals  $\psi_{(A)}$  and  $\psi_{(B)}$  combine, they give rise to a pair of molecular orbitals  $\psi_{(g)}$  and  $\psi_{(u)}$ . The number of molecular orbitals produced must always be equal to the number of atomic orbitals involved. The function  $\psi_{(g)}$  leads to increased electron density in between the nuclei, and is therefore a bonding molecular orbital. It is lower in energy than the original atomic orbitals. Conversely  $\psi_{(u)}$  results in two lobes of opposite sign cancelling and hence giving zero electron density in between the nuclei. This is an antibonding molecular orbital which is higher in energy (Figure 4.15).

The molecular orbital wave functions are designated  $\psi_{(g)}$  and  $\psi_{(u)}$ ; g stands for *gerade* (even) and u for *ungerade* (odd). g and u refer to the symmetry of the orbital about its centre. If the sign of the wave function is unchanged when the orbital is reflected about its centre (i.e. x, y and z are replaced by -x, -y and -z) the orbital is *gerade*. An alternative method

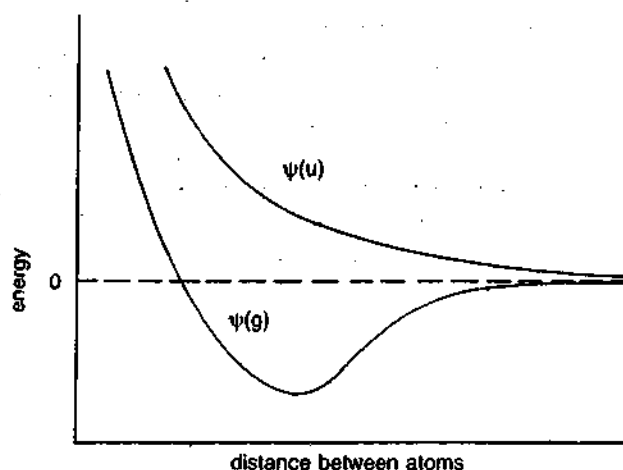

Figure 4.15 Energy of  $\psi(g)$  and  $\psi(u)$  molecular orbitals.

for determining the symmetry of the molecular orbital is to rotate the orbital about the line joining the two nuclei and then about a line perpendicular to this. If the sign of the lobes remains the same, the orbital is *gerade*, and if the sign changes, the orbital is *ungerade*.

The energy of the bonding molecular orbital  $\psi(g)$  passes through a minimum (Figure 4.15), and the distance between the atoms at this point corresponds to the internuclear distance between the atoms when they form a bond. Consider the energy levels of the two  $1s$  atomic orbitals, and of the bonding  $\psi(g)$  and antibonding  $\psi(u)$  orbitals (Figure 4.16).

The energy of the bonding molecular orbital is lower than that of the atomic orbital by an amount  $\Delta$ . This is known as the stabilization energy.

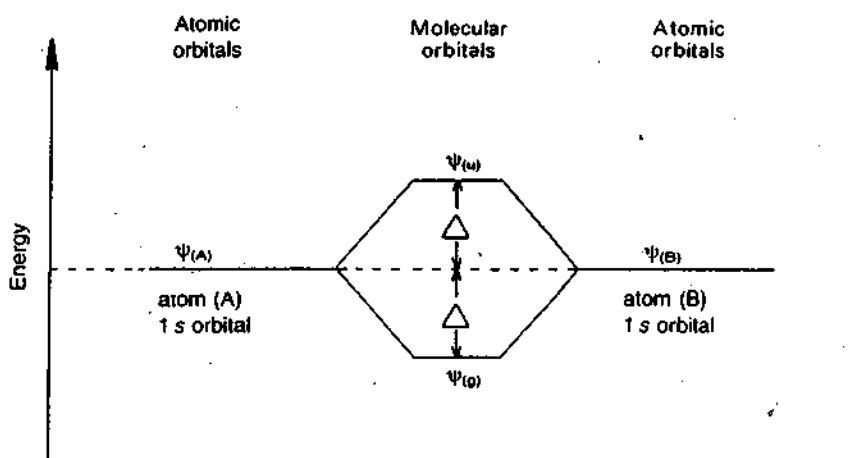

Figure 4.16 Energy levels of  $s-s$  atomic and molecular orbitals.

Similarly the energy of the antibonding molecular orbital is increased by  $\Delta$ . Atomic orbitals may hold up to two electrons (provided that they have opposite spins) and the same applies to molecular orbitals. In the case of two hydrogen atoms combining, there are two electrons to be considered: one from the  $1s$  orbital of atom A and one from the  $1s$  orbital of atom B. When combined, these two electrons both occupy the bonding molecular orbital  $\psi_{(g)}$ . This results in a saving of energy of  $2\Delta$ , which corresponds to the bond energy. It is only because the system is stabilized in this way that a bond is formed.

Consider the hypothetical case of two He atoms combining. The  $1s$  orbitals on each He contain two electrons, making a total of four electrons to put into molecular orbitals. Two of the electrons occupy the bonding MO, and two occupy the antibonding MO. The stabilization energy  $2\Delta$  derived from filling the bonding MO is offset by the  $2\Delta$  destabilization energy from using the antibonding MO. Since overall there is no saving of energy,  $\text{He}_2$  does not exist, and this situation corresponds to non-bonding.

Some further symbols are necessary to describe the way in which the atomic orbitals overlap. Overlap of the orbitals along the axis joining the nuclei produces  $\sigma$  molecular orbitals, whilst lateral overlap of atomic orbitals forms  $\pi$  molecular orbitals.

#### $s-p$ combinations of orbitals

An  $s$  orbital may combine with a  $p$  orbital provided that the lobes of the  $p$  orbital are pointing along the axis joining the nuclei. When the lobes which overlap have the same sign this results in a bonding MO with an increased electron density between the nuclei. When the overlapping lobes have

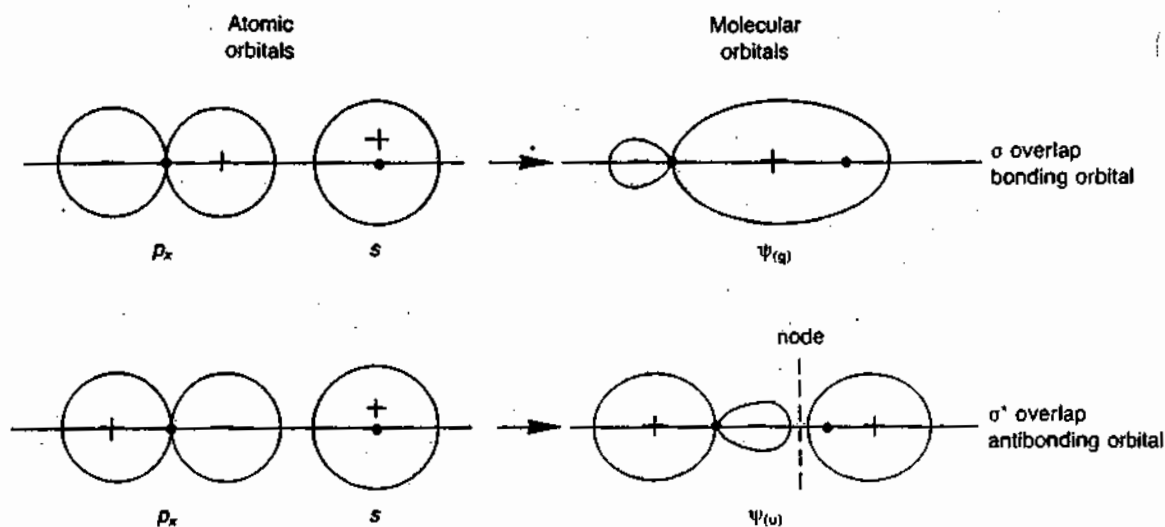

Figure 4.17  $s-p$  combination of atomic orbitals.

opposite signs this gives an antibonding MO with a reduced electron density in between the nuclei (Figure 4.17).

### $p-p$ combinations of orbitals

Consider first the combination of two  $p$  orbitals which both have lobes pointing along the axis joining the nuclei. Both a bonding MO and an antibonding MO are produced (Figure 4.18).

Next consider the combination of two  $p$  orbitals which both have lobes perpendicular to the axis joining the nuclei. Lateral overlap of orbitals will

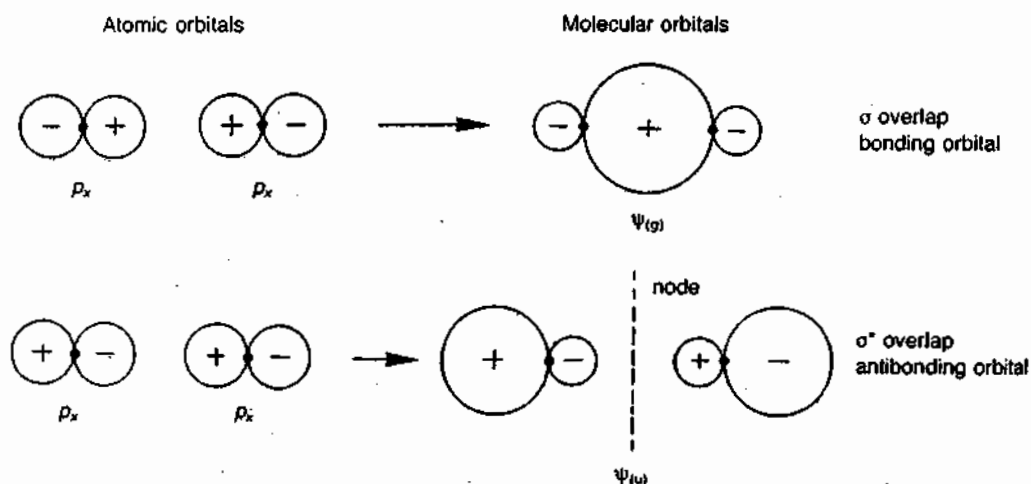

Figure 4.18  $p-p$  combination of atomic orbitals.

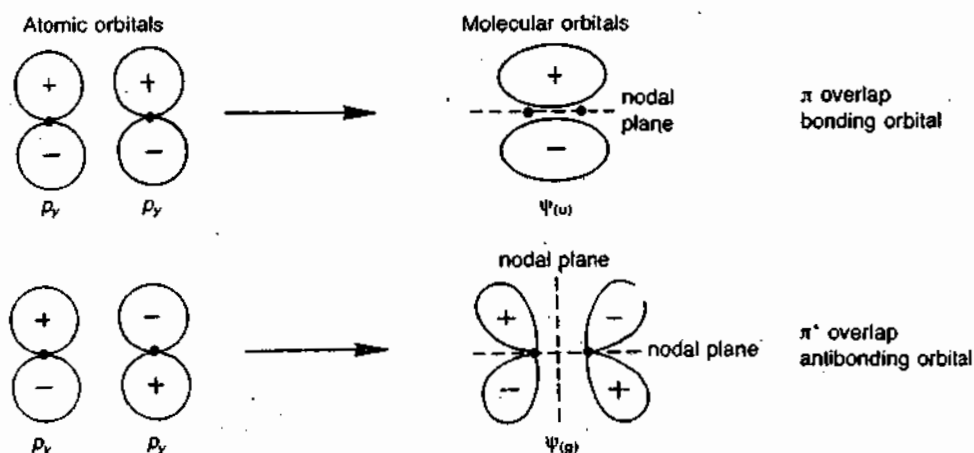

Figure 4.19  $p-p$  combinations giving  $\pi$  bonding.



occur, resulting in  $\pi$  bonding and  $\pi^*$  antibonding MOs being produced (Figure 4.19).

There are three points of difference between these molecular orbitals and the  $\sigma$  orbitals described previously:

1. For  $\pi$  overlap the lobes of the atomic orbitals are perpendicular to the line joining the nuclei, whilst for  $\sigma$  overlap the lobes point along the line joining the two nuclei.
2. For  $\pi$  molecular orbitals,  $\psi$  is zero along the internuclear line and consequently the electron density  $\psi^2$  is also zero. This is in contrast to  $\sigma$  orbitals.
3. The symmetry of  $\pi$  molecular orbitals is different from that shown by  $\sigma$  orbitals. If the bonding  $\pi$  MO is rotated about the internuclear line a change in the sign of the lobe occurs. The  $\pi$  bonding orbitals are therefore *ungerade*, whereas all  $\sigma$  bonding MOs are *gerade*. Conversely the antibonding  $\pi$  MO is *gerade* whilst all  $\sigma$  antibonding MOs are *ungerade*.

Pi bonding is important in many organic compounds such as ethene (where there is one  $\sigma$  bond and one  $\pi$  bond between the two carbon atoms), ethyne (one  $\sigma$  and two  $\pi$ ), and benzene, and also in a number of inorganic compounds such as  $\text{CO}_2$  and  $\text{CN}^-$ .

Ethene contains a localized double bond, which involves only the two carbon atoms. Experimental measurements show that the two C atoms and the four H atoms are coplanar, and the bond angles are close to  $120^\circ$ . Each C atom uses its  $2s$  and two  $2p$  orbitals to form three  $sp^2$  hybrid orbitals that form  $\sigma$  bonds to the other C atom and two H atoms. The remaining  $p$  orbital on each C atom is at right angles to the  $\sigma$  bonds so far formed. In the valence bond theory these two  $p$  orbitals overlap sideways to give a  $\pi$  bond. This sideways overlap is not as great as the end to end overlap in  $\sigma$  bonds so a  $\text{C}=\text{C}$ , though stronger than a  $\text{C}-\text{C}$  bond, is not twice as strong ( $\text{C}-\text{C}$  in ethane  $598 \text{ kJ mol}^{-1}$ ,  $\text{C}=\text{C}$  in ethene  $346 \text{ kJ mol}^{-1}$ ). The molecule can be twisted about the  $\text{C}-\text{C}$  bond in ethane, but it cannot be twisted in ethene since this would reduce the amount of  $\pi$  overlap. In the molecular orbital theory the explanation of the  $\pi$  bonding is slightly different. The two  $p$  orbitals involved in  $\pi$  bonding combine to form two  $\pi$  molecular orbitals, one bonding and one antibonding. Since there are only two electrons involved, these occupy the  $\pi$  bonding MO since this has the lower energy. The molecular orbital explanation becomes more important in cases where there is non-localized  $\pi$  bonding, that is where  $\pi$  bonding covers several atoms as in benzene,  $\text{NO}_3^-$  and  $\text{CO}_3^{2-}$ .

In ethyne each C atom uses  $sp$  hybrid orbitals to form  $\sigma$  bonds to the other C atom and a H atom. These four atoms form a linear molecule. Each C atom has two  $p$  orbitals at right angles to one another, and these overlap sideways with the equivalent  $p$  orbitals on the other C atom, thus forming two  $\pi$  bonds. Thus a  $\text{C}\equiv\text{C}$  triple bond is formed, which is stronger than a  $\text{C}=\text{C}$  double bond ( $\text{C}\equiv\text{C}$  in ethyne  $813 \text{ kJ mol}^{-1}$ ).

The majority of strong  $\pi$  bonds occur between elements of the first short

period in the periodic table, for example  $C\equiv C$ ,  $C\equiv N$ ,  $C\equiv O$ ,  $C=C$  and  $C=O$ . This is mainly because the atoms are smaller and hence the orbitals involved are reasonably compact, so it is possible to get substantial overlap of orbitals. There are a smaller number of cases where  $\pi$  bonding occurs between different types of orbitals, for example the  $2p$  and  $3d$  orbitals. Though these orbitals are much larger, the presence of nodes may concentrate electron density in certain parts of the orbitals.

#### p-d combinations of orbitals

A  $p$  orbital on one atom may overlap with a  $d$  orbital on another atom as shown, giving bonding and antibonding combinations. Since the orbitals do not point along the line joining the two nuclei, overlap must be of the  $\pi$  type (Figure 4.20). This type of bonding is responsible for the short bonds found in the oxides and oxoacids of phosphorus and sulphur. It also occurs in transition metal complexes such as the carbonyls and cyanides.

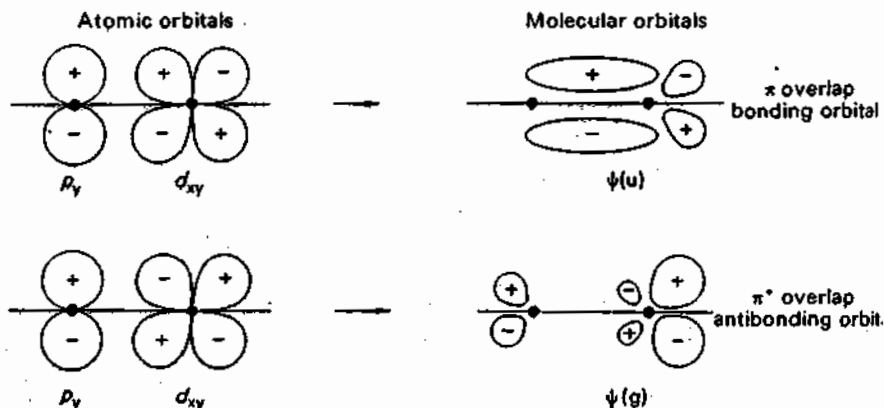
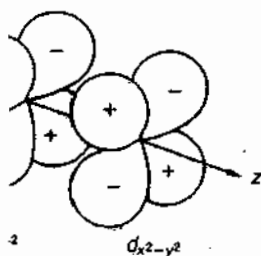

Figure 4.20  $p$ - $d$  combinations of atomic orbitals.



21  $\delta$  bonding by  $d$  sideways overlap of two orbitals.

#### d-d combinations of orbitals

It is possible to combine two  $d$  atomic orbitals, producing bonding and antibonding MOs which are called  $\delta$  and  $\delta^*$  respectively. On rotating these orbitals about the internuclear axis, the sign of the lobes changes four times compared with two changes with  $\pi$  overlap and no change for  $\sigma$  overlap.

#### Non-bonding combinations of orbitals

All the cases of overlap of atomic orbitals considered so far have resulted in a bonding MO of lower energy, and an antibonding MO of higher energy. To obtain a bonding MO with a concentration of electron density in between the nuclei, the signs (symmetry) of the lobes which overlap

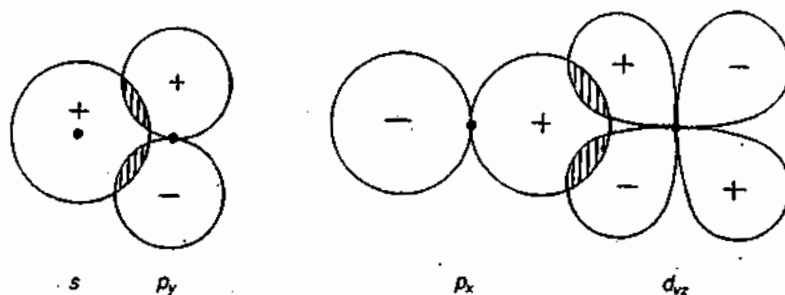

Figure 4.22 Some non-bonding combinations of atomic orbitals.

must be the same. Similarly for antibonding MOs the signs of the overlapping lobes must be different. In the combinations shown in Figure 4.22 any stabilization which occurs from overlapping + with + is destabilized by an equal amount of overlap of + with -. There is no overall change in energy, and this situation is termed non-bonding. It should be noted that in all of these non-bonding cases the symmetry of the two atomic orbitals is different, i.e. rotation about the axis changes the sign of one.

#### RULES FOR LINEAR COMBINATION OF ATOMIC ORBITALS

In deciding which atomic orbitals may be combined to form molecular orbitals, three rules must be considered:

1. The atomic orbitals must be roughly of the same energy. This is important when considering overlap between two different types of atoms.
2. The orbitals must overlap one another as much as possible. This implies that the atoms must be close enough for effective overlap and that the radial distribution functions of the two atoms must be similar at this distance.
3. In order to produce bonding and antibonding MOs, either the symmetry of the two atomic orbitals must remain unchanged when rotated about the internuclear line, or both atomic orbitals must change symmetry in an identical manner.

In the same way that each atomic orbital has a particular energy, and may be defined by four quantum numbers, each molecular orbital has a definite energy, and is also defined by four quantum numbers.

1. The principal quantum number  $n$  has the same significance as in atomic orbitals.
2. The subsidiary quantum number  $l$  also has the same significance as in atomic orbitals.
3. The magnetic quantum number of atomic orbitals is replaced by a new quantum number  $\lambda$ . In a diatomic molecule, the line joining the nuclei is taken as a reference direction and  $\lambda$  represents the quantization of angular momentum in  $h/2\pi$  units with respect to this axis.  $\lambda$  takes the same values as  $m$  takes for atoms, i.e.

$$\lambda = -l, \dots, -3, -2, -1, 0, +1, +2, +3, \dots, +l$$

When  $\lambda = 0$ , the orbitals are symmetrical around the axis and are called  $\sigma$  orbitals. When  $\lambda = \pm 1$  they are called  $\pi$  orbitals and when  $\lambda = \pm 2$  they are called  $\delta$  orbitals.

4. The spin quantum number is the same as for atomic orbitals and may have values of  $\pm \frac{1}{2}$ .

The Pauli exclusion principle states that in a given atom no two electrons can have all four quantum numbers the same. The Pauli principle also applies to molecular orbitals: No two electrons in the same molecule can have all four quantum numbers the same.

The order of energy of molecular orbitals has been determined mainly from spectroscopic data. In simple homonuclear diatomic molecules, the order is:

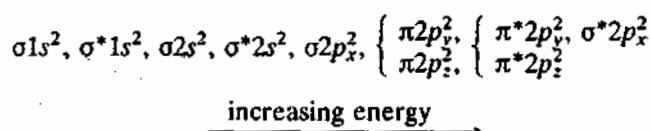

Note that the  $2p_y$  atomic orbital gives  $\pi$  bonding and  $\pi^*$  antibonding MOs and the  $2p_z$  atomic orbital gives  $\pi$  bonding and  $\pi^*$  antibonding MOs. The bonding  $\pi 2p_y$  and  $\pi 2p_z$  MOs have exactly the same energy and are said to be double degenerate. In a similar way the antibonding  $\pi^* 2p_y$  and  $\pi^* 2p_z$  MOs have the same energy and are also doubly degenerate.

A similar arrangement of MOs exists from  $\sigma 3s$  to  $\sigma^* 3p_x$ , but the energies are known with less certainty.

The energies of the  $\sigma 2p$  and  $\pi 2p$  MOs are very close together. The order of MOs shown above is correct for nitrogen and heavier elements, but for the lighter elements boron and carbon the  $\pi 2p_y$  and  $\pi 2p_z$  are probably lower than  $\sigma 2p_x$ . For these atoms the order is:

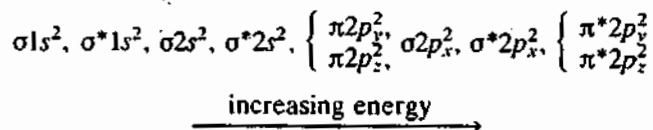

### EXAMPLES OF MOLECULAR ORBITAL TREATMENT FOR HOMONUCLEAR DIATOMIC MOLECULES

In the build-up of atoms, electrons are fed into atomic orbitals. The *Aufbau* principle is used:

1. Orbitals of lowest energy are filled first.
2. Each orbital may hold up to two electrons, provided that they have opposite spins.

Hund's rule states that when several orbitals have the same energy (that is they are degenerate), electrons will be arranged so as to give the maximum number of unpaired spins.

In the molecular orbital method, we consider the whole molecule rather than the constituent atoms, and use molecular orbitals rather than atomic orbitals. In the build-up of the molecule, the total number of electrons from all the atoms in the molecule is fed into molecular orbitals. The *Aufbau* principle and Hund's rule are used as before.

For simplicity homonuclear diatomic molecules will be examined first. Homonuclear means that there is only one type of nucleus, that is one element present, and diatomic means that the molecule is composed of two atoms.

$H_2^+$  molecule ion

This may be considered as a combination of a H atom with a  $H^+$  ion. This gives one electron in the molecular ion which occupies the lowest energy MO:



The electron occupies the  $\sigma 1s$  bonding MO. The energy of this ion is thus lower than that of the constituent atom and ion, by an amount  $\Delta$ , so there is some stabilization. This species exists but it is not common since  $H_2$  is much more stable. However,  $H_2^+$  can be detected spectroscopically when  $H_2$  gas under reduced pressure is subjected to an electric discharge.

$H_2$  molecule

There is one electron from each atom, and hence there are two electrons in the molecule. These occupy the lowest energy MO:



This is shown in Figure 4.23. The bonding  $\sigma 1s$  MO is full, so the stabilization energy is  $2\Delta$ . A  $\sigma$  bond is formed, and the  $H_2$  molecule exists and is well known.

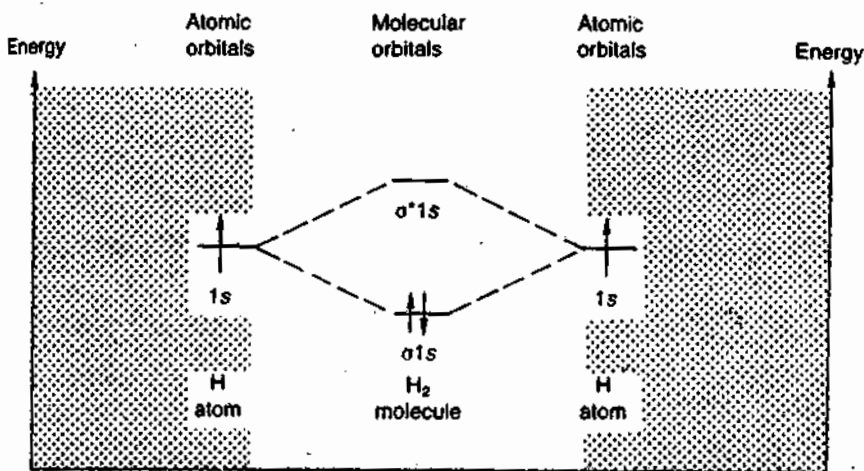
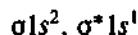

Figure 4.23 Electronic configuration, atomic and molecular orbitals for hydrogen.

**He<sub>2</sub><sup>+</sup> molecule ion**

This may be considered as a combination of a He atom and a He<sup>+</sup> ion. There are three electrons in the molecular ion, which are arranged in MOs:



The filled  $\sigma 1s$  bonding MO gives  $2\Delta$  stabilization, whilst the half filled  $\sigma 1s^*$  gives  $\Delta$  destabilization. Overall there is  $\Delta$  stabilization. Thus the helium molecule ion can exist. It is not very stable, but it has been observed spectroscopically.

**He<sub>2</sub> molecule**

There are two electrons from each atom, and the four electrons are arranged in MOs:

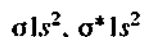

The  $2\Delta$  stabilization energy from filling the  $\sigma 2s$  MO is cancelled by the  $2\Delta$  destabilization energy from filling the  $\sigma^* 1s$  MO. Thus a bond is not formed, and the molecule does not exist.

**Li<sub>2</sub> molecule**

Each Li atom has two electrons in its inner shell, and one in its outer shell, giving three electrons. Thus there is a total of six electrons in the molecule, and these are arranged in MOs:

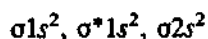

This is shown in Figure 4.24. The inner shell of filled  $\sigma 1s$  MOs does not contribute to the bonding in much the same way as in He<sub>2</sub>. They are essentially the same as the atomic orbitals from which they were formed, and are sometimes written:

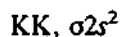

However, bonding occurs from the filling of the  $\sigma 2s$  level, and Li<sub>2</sub> molecules do exist in the vapour state. However, in the solid it is energetically more favourable for lithium to form a metallic structure. Other Group I metals such as sodium behave in an analogous way:

**Be<sub>2</sub> molecule**

A beryllium atom has two electrons in the first shell plus two electrons in the second shell. Thus in the Be<sub>2</sub> molecule there are eight electrons. These are arranged in MOs:

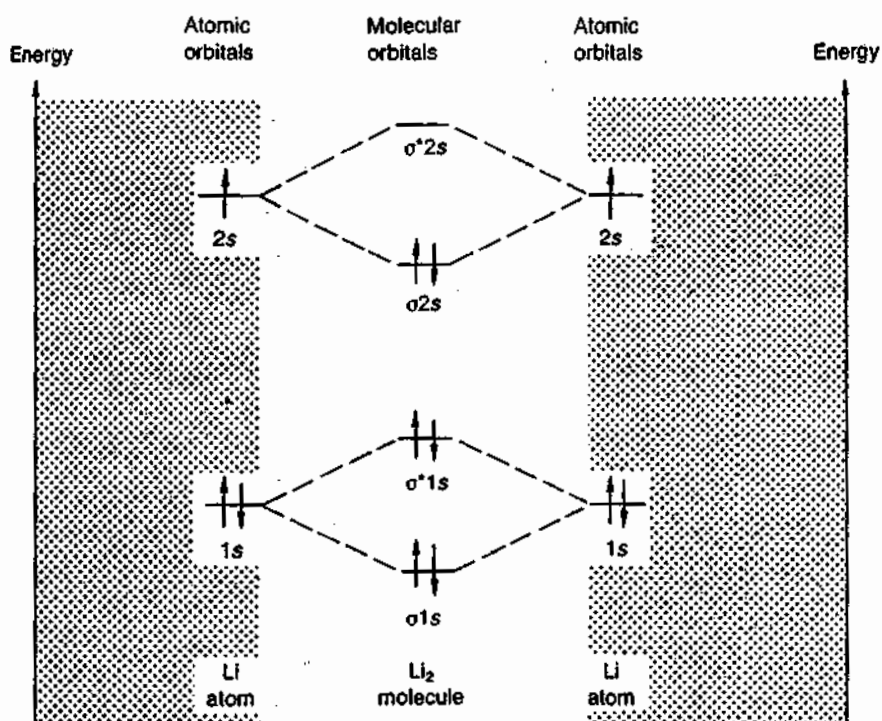
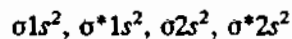
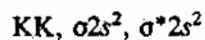

Figure 4.24 Electronic configuration, atomic and molecular orbitals for lithium.



or



Ignoring the inner shell as before, it is apparent that the effects of the bonding  $\sigma_{2s}$  and antibonding  $\sigma^*_{2s}$  levels cancel, so there is no stabilization and the molecule would not be expected to exist.

### $\text{B}_2$ molecule

Each boron atom has  $2 + 3$  electrons. The  $\text{B}_2$  molecule thus contains a total of ten electrons, which are arranged in MOs:

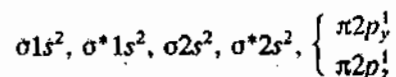

This may be shown diagrammatically (Figure 4.25). Note that B is a light atom and the order of energies of MOs is different from the 'usual' arrangement. Thus the  $\pi_{2p}$  orbitals are lower in energy than the  $\sigma_{2p_x}$ . Since the  $\pi_{2p_y}$  and  $\pi_{2p_z}$  orbitals are degenerate (identical in energy), Hund's rule applies, and each is singly occupied. The inner shell does not

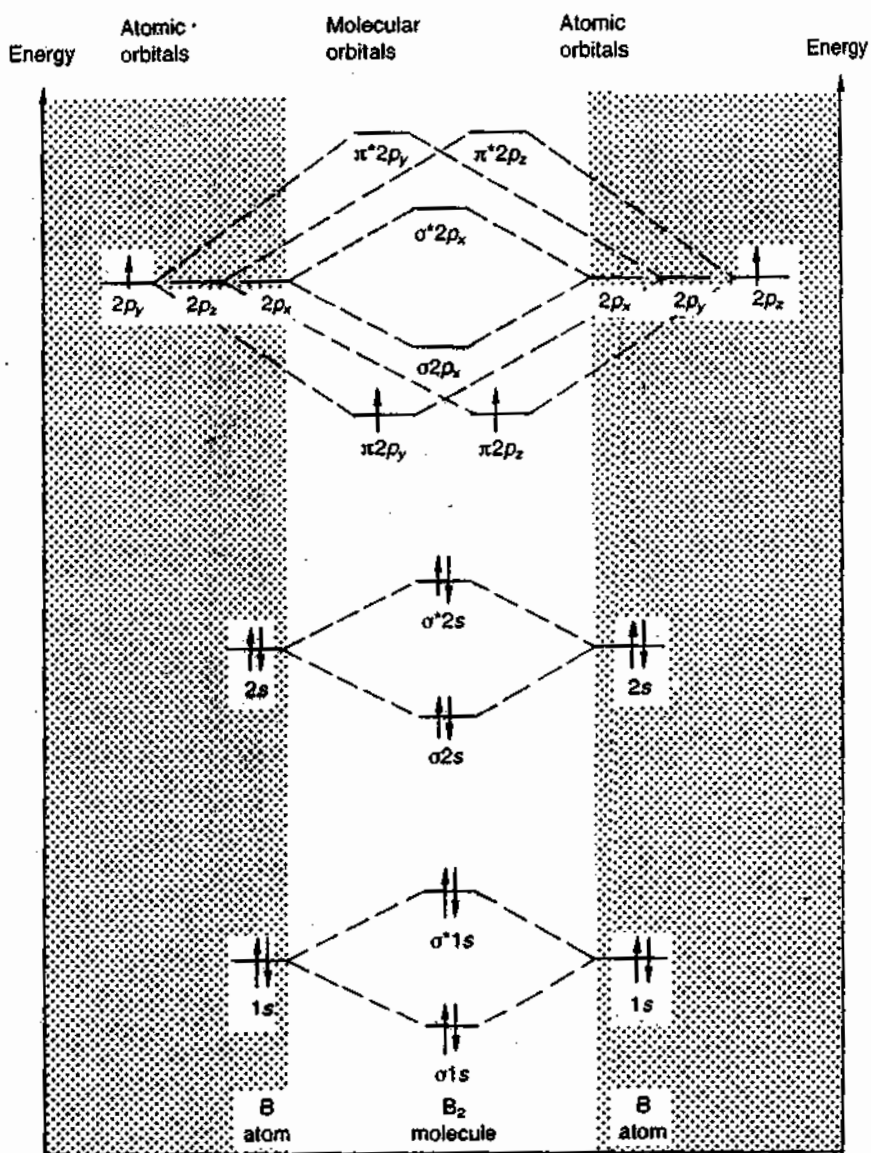

Figure 4.25 Electronic configuration, atomic and molecular orbitals for boron.

participate in bonding. The effects of bonding and antibonding  $\sigma_{2s}$  orbitals cancel but stabilization occurs from the filling of the  $\pi_{2p}$  orbitals, and hence a bond is formed and B<sub>2</sub> exists.

### C<sub>2</sub> molecule

A carbon atom has 2 + 4 electrons. A C<sub>2</sub> molecule would contain a total of 12 electrons, and these would be arranged in MOs:



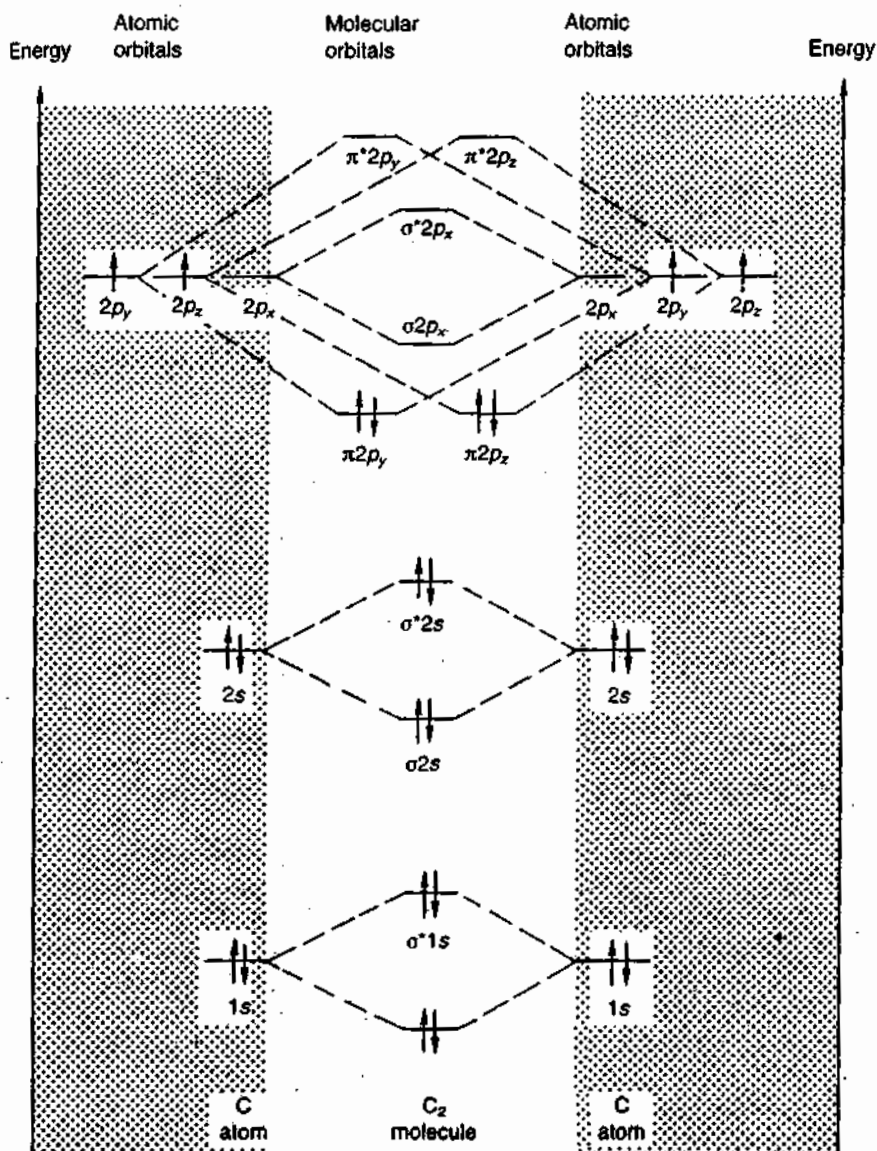

Figure 4.26 Electronic configuration, atomic and molecular orbitals for carbon.

$$\sigma 1s^2, \sigma^* 1s^2, \sigma 2s^2, \sigma^* 2s^2, \begin{cases} \pi 2p_y^2 \\ \pi 2p_z^2 \end{cases}$$

This is shown diagrammatically in Figure 4.26.

The molecule should be stable, since the two  $\pi 2p$  bonding orbitals provide  $4\Delta$  of stabilization energy, giving two bonds. In fact carbon exists as a macromolecule in graphite and diamond, since these are an even more stable arrangement (where each carbon forms four bonds): hence diamond and graphite are formed in preference to C<sub>2</sub>.

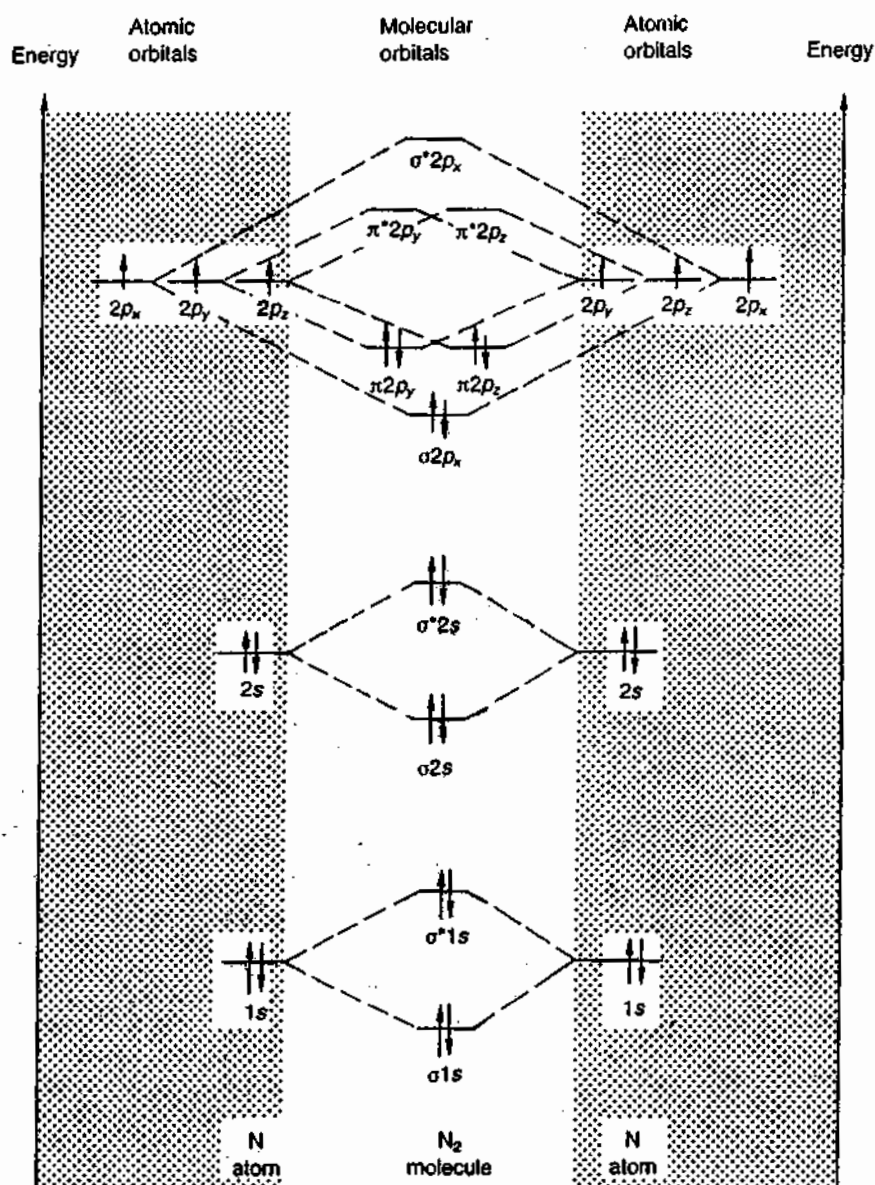

Figure 4.27 Electronic configuration, atomic and molecular orbitals for nitrogen.

### $N_2$ molecule

A nitrogen atom has  $2 + 5 = 7$  electrons. Thus the  $N_2$  molecule contains 14 electrons. These are arranged in MOs:

$$\sigma 1s^2, \sigma^* 1s^2, \sigma 2s^2, \sigma^* 2s^2, \sigma 2p_x^2, \begin{cases} \pi 2p_y^2 \\ \pi 2p_z^2 \end{cases}$$

This is shown diagrammatically (Figure 4.27).

Assuming that the inner shell does not participate in bonding, and that the bonding and antibonding  $2s$  levels cancel, one  $\sigma$  and two  $\pi$  bonding pairs remain, giving a total of three bonds. This is in agreement with the valence bond formulation as  $\text{N}\equiv\text{N}$ .

### $\text{O}_2$ molecule

Each oxygen atom has  $2 + 6 = 8$  electrons. Thus the  $\text{O}_2$  molecule contains a total of 16 electrons. These are arranged in MOs:

$$\sigma 1s^2, \sigma^* 1s^2, \sigma 2s^2, \sigma^* 2s^2, \sigma 2p_x^2, \begin{cases} \pi 2p_y^2 \\ \pi 2p_z^2 \end{cases}, \begin{cases} \pi^* 2p_y^1 \\ \pi^* 2p_z^1 \end{cases}$$

This is shown diagrammatically in Figure 4.28.

The antibonding  $\pi^* 2p_y$  and  $\pi^* 2p_z$  orbitals are singly occupied in accordance with Hund's rule. Unpaired electrons give rise to paramagnetism. Since there are two unpaired electrons with parallel spins, this explains why oxygen is paramagnetic. If this treatment is compared with the Lewis electron pair theory or the valence bond theory, these do not predict unpaired electrons or paramagnetism.

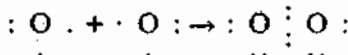

This was the first success of the Molecular orbital theory in successfully predicting the paramagnetism of  $\text{O}_2$ , a fact not even thought of with a valence bond representation of  $\text{O}=\text{O}$ .

As in the previous examples, the inner shell does not participate in bonding and the bonding and antibonding  $2s$  orbitals cancel each other. A  $\sigma$  bond results from the filling of  $\sigma 2p_x^2$ . Since  $\pi^* 2p_y^1$  is half filled and therefore cancels half the effect of the completely filled  $\pi 2p_y^2$  orbital, half of a  $\pi$  bond results. Similarly another half of a  $\pi$  bond arises from  $\pi 2p_z^2$  and  $\pi^* 2p_z^1$ , giving a total of  $1 + \frac{1}{2} + \frac{1}{2} = 2$  bonds. The bond order is thus two.

Instead of working out the bond order by cancelling the effects of filled bonding and antibonding MOs, the bond order may be calculated as half the difference between the number of bonding and antibonding electrons:

$$\text{Bond order} = \frac{\left( \begin{array}{c} \text{number of electrons} \\ \text{occupying bonding orbitals} \end{array} \right) - \left( \begin{array}{c} \text{number of electrons} \\ \text{in antibonding orbitals} \end{array} \right)}{2}$$

In the case of  $\text{O}_2$  the bond order calculates as  $(10 - 6)/2 = 2$ , which corresponds to a double bond.

### $\text{O}_2^-$ ion

The compound potassium superoxide  $\text{KO}_2$  contains the superoxide ion  $\text{O}_2^-$ . The  $\text{O}_2^-$  ion has 17 electrons, and has one more electron than the  $\text{O}_2$

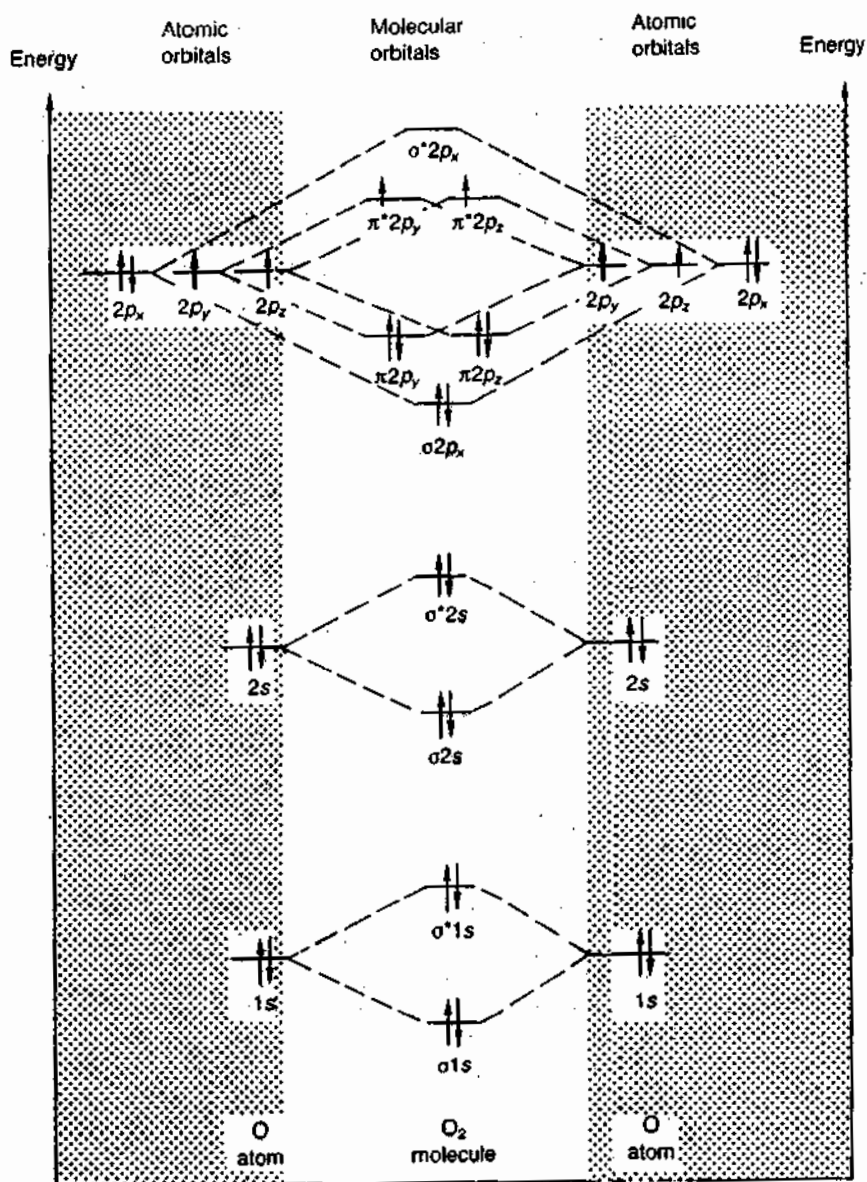

Figure 4.28 Electronic configuration, atomic and molecular orbitals for oxygen.

molecule. This extra electron occupies either the  $\pi^*2p_y$  or  $\pi^*2p_z$  orbital. It does not matter which it occupies since they are the same energy.

$$\sigma 1s^2, \sigma^* 1s^2, \sigma 2s^2, \sigma^* 2s^2, \sigma 2p_x^2, \begin{cases} \pi 2p_y^2 \\ \pi 2p_z^2 \end{cases}, \begin{cases} \pi^* 2p_y^1 \\ \pi^* 2p_z^1 \end{cases}$$

The inner shell of electrons does not take part in bonding. The bonding  $\sigma 2s^2$  and antibonding  $\sigma^* 2s^2$  cancel. The  $\sigma 2p_x^2$  orbital is filled and forms a

$\sigma$  bond. The effects of the bonding  $\pi 2p_y^2$  and antibonding  $\pi 2p_y^2$  orbitals cancel, and the completely filled bonding  $\pi 2p_z^2$  is half cancelled by the half filled antibonding  $\pi 2p_z^1$ , thus giving half a  $\pi$  bond. The bond order is thus  $1 + \frac{1}{2} = 1\frac{1}{2}$ . Alternatively the bond order may be calculated like this: (bonding - antibonding)/2, that is  $(10 - 7)/2 = 1\frac{1}{2}$ . This corresponds to a bond that is intermediate in length between a single and a double bond. The superoxide ion has an unpaired electron and is therefore paramagnetic. (A bond order of  $1\frac{1}{2}$  is well accepted in benzene.)

### $O_2^{2-}$ ion

In a similar way sodium peroxide  $Na_2O_2$  contains the peroxide ion  $O_2^{2-}$ . This ion has 18 electrons, arranged:

$$\sigma 1s^2, \sigma^* 1s^2, \sigma 2s^2, \sigma^* 2s^2, \sigma 2p_x^2, \begin{cases} \pi 2p_y^2 \\ \pi 2p_z^2 \end{cases}, \begin{cases} \pi^* 2p_y^2 \\ \pi^* 2p_z^2 \end{cases}$$

Once again the inner shell takes no part in bonding. The bonding and antibonding  $2s$  orbitals completely cancel each other. One  $\sigma$  bond forms from the filled  $2p_x$  orbital. Both the bonding  $2p_y$  and  $2p_z$  orbitals are cancelled out by their corresponding antibonding orbitals. Thus the bond order is one, that is a single bond. Alternatively the bond order may be calculated as (bonding - antibonding)/2, that is  $(10 - 8)/2 = 1$ .

### $F_2$ molecule

Fluorine atoms have  $2 + 7$  electrons, so an  $F_2$  molecule contains 18 electrons. These are arranged:

$$\sigma 1s^2, \sigma^* 1s^2, \sigma 2s^2, \sigma^* 2s^2, \sigma 2p_x^2, \begin{cases} \pi 2p_y^2 \\ \pi 2p_z^2 \end{cases}, \begin{cases} \pi^* 2p_y^2 \\ \pi^* 2p_z^2 \end{cases}$$

This is shown diagrammatically in Figure 4.29.

The inner shell is non-bonding, and the filled bonding  $2s$ ,  $2p_y$  and  $2p_z$  are cancelled by the equivalent antibonding orbitals. This leaves a  $\sigma$  bond from the filled  $\sigma 2p_x^2$  orbital, and thus a bond order of one. Alternatively the bond order may be calculated as (bonding - antibonding)/2, that is  $(10 - 8)/2 = 1$ .

It should be noted that  $Cl_2$  and  $Br_2$  have structures analogous to  $F_2$ , except that additional inner shells of electrons are full.

The F—F bond is rather weak (see Chapter 15) and this is attributed to the small size of fluorine and repulsion between lone pairs of electrons on adjacent atoms.

## EXAMPLES OF MOLECULAR ORBITAL TREATMENT FOR HETERONUCLEAR DIATOMIC MOLECULES

The same principles apply when combining atomic orbitals from two different atoms as applied when the atoms were identical, that is:

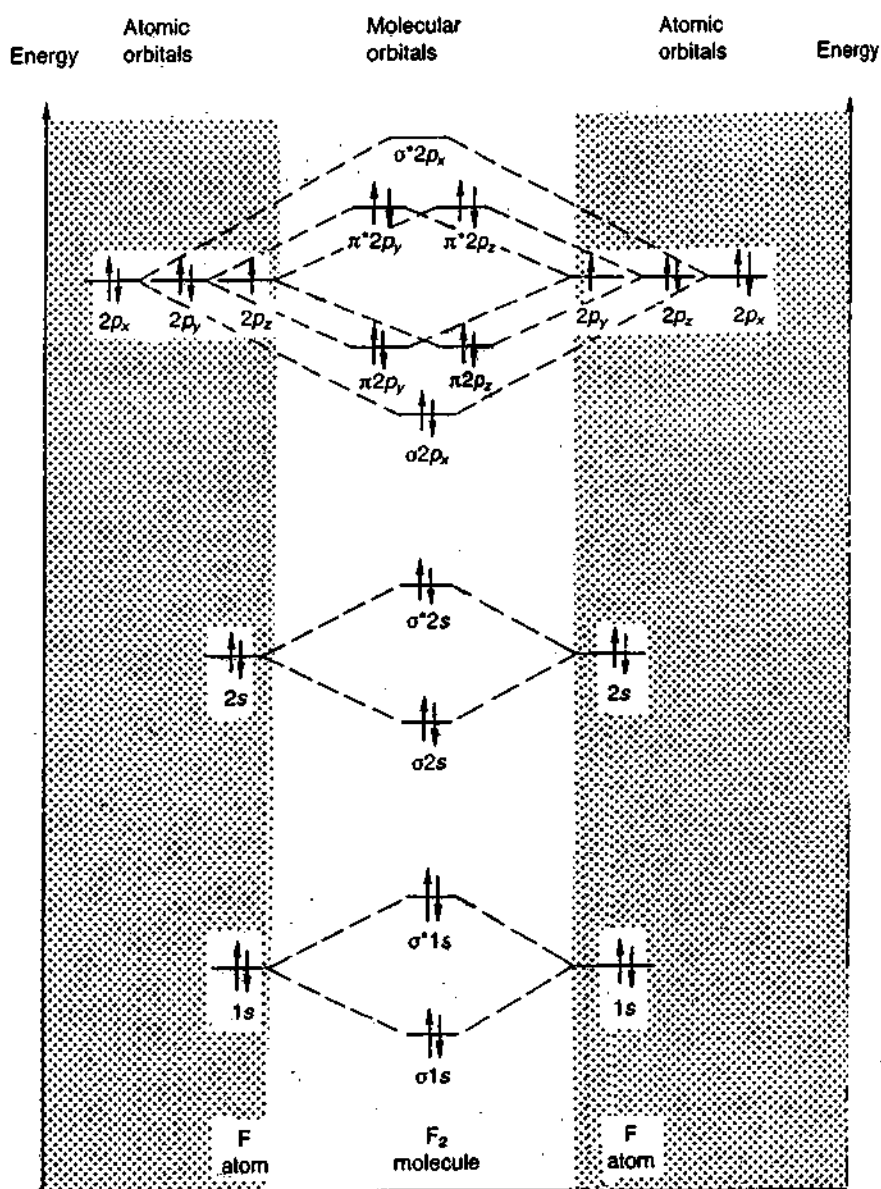

Figure 4.29 Electronic configuration, atomic and molecular orbitals for fluorine.

1. Only atomic orbitals of about the same energy can combine effectively.
2. They should have the maximum overlap.
3. They must have the same symmetry.

Since the two atoms are different, the energies of their atomic orbitals are slightly different. A diagram showing how they combine to form molecular orbitals is given in Figure 4.30.

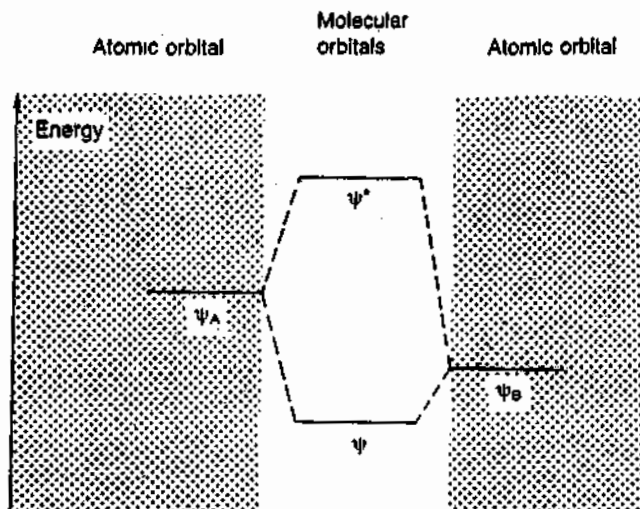

Figure 4.30 The relative energy levels of atomic orbitals and molecular orbitals for a heteronuclear diatomic molecule AB.

The problem is that in many cases the order of MO energy levels is not known with certainty. Thus we will consider first some examples where the two different atoms are close to each other in the periodic table, and consequently it is reasonable to assume that the order of energies for the MOs are the same as for homonuclear molecules.

#### NO molecule

The nitrogen atom has  $2 + 5 = 7$  electrons, and the oxygen atom has  $2 + 6 = 8$  electrons, making 15 electrons in the molecule. The order of energy levels of the various MOs are the same as for homonuclear diatomic molecules heavier than  $C_2$ , so the arrangement is:

$$\sigma 1s^2, \sigma^* 1s^2, \sigma 2s^2, \sigma^* 2s^2, \sigma 2p_x^2, \begin{cases} \pi 2p_y^2 \\ \pi 2p_z^2 \end{cases}, \begin{cases} \pi^* 2p_y^1 \\ \pi^* 2p_z^0 \end{cases}$$

This is shown in Figure 4.31.

The inner shell is non-bonding. The bonding and antibonding  $2s$  orbitals cancel, and a  $\sigma$  bond is formed by the filled  $\sigma 2p_x^2$  orbital. A  $\pi$  bond is formed by the filled  $\pi 2p_z^2$  orbital. The half filled  $\pi^* 2p_y^1$  half cancels the filled  $\pi 2p_y^2$  orbital, thus giving half a bond. The bond order is thus  $2\frac{1}{2}$ , that is in between a double and a triple bond. Alternatively the bond order may be worked out as  $(\text{bonding} - \text{antibonding})/2$ , that is  $(10 - 5)/2 = 2\frac{1}{2}$ . The molecule is paramagnetic since it contains an unpaired electron. In NO there is a significant difference of about  $250 \text{ kJ mol}^{-1}$  in the energy of the AOs involved, so that combination of AOs to give MOs is less effective than in  $O_2$  or  $N_2$ . The bonds are therefore weaker than might be expected. Apart from this the molecular orbital pattern (Figure 4.31)

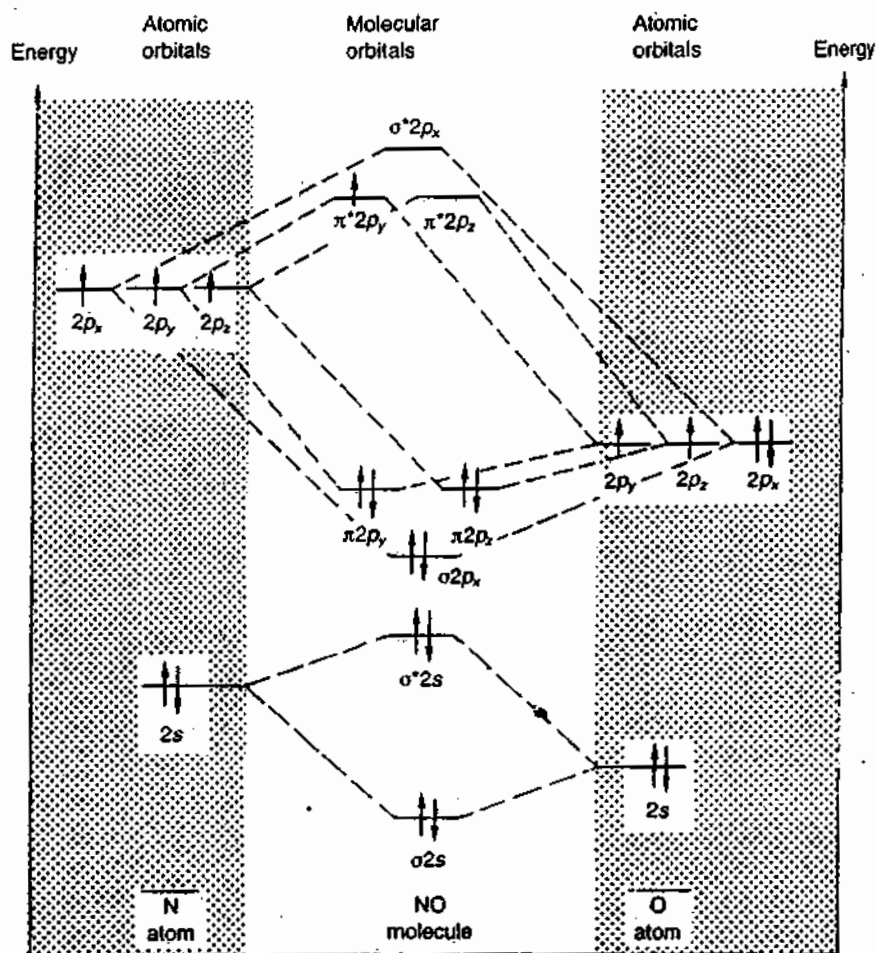

Figure 4.31 Electronic configuration, atomic orbitals and molecular orbitals for nitric oxide. (This diagram is essentially the same as that for homonuclear diatomic molecules such as  $N_2$ ,  $O_2$  or  $F_2$ . The difference is that the atomic energy levels of N and O are not the same.)

is similar to that for homonuclear diatomic molecules. Removal of one electron to make  $NO^+$  results in a shorter and stronger bond because the electron is removed from an antibonding orbital, thus increasing the bond order to 3.

#### CO molecule

The carbon atom has  $2 + 4 = 6$  electrons, and the O atom has  $2 + 6 = 8$  electrons, so the CO molecule contains 14 electrons. In this case we are rather less certain of the order of energies of the MOs, since they are different for C and O. Assume the order is the same as for light atoms like C:



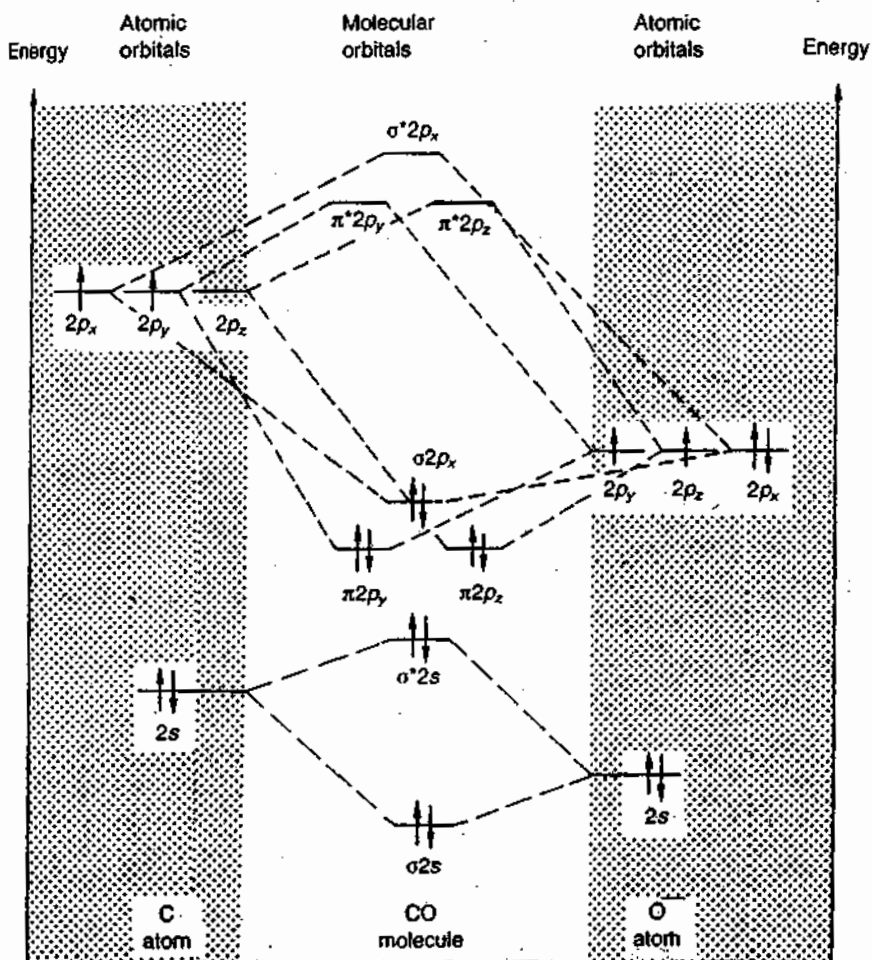
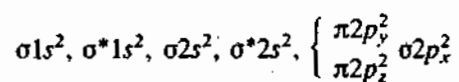

Figure 4.32 Electronic configuration, atomic orbitals and molecular orbitals for carbon monoxide.



This is shown in Figure 4.32.

The inner shell is non-bonding, and the bonding and antibonding  $2s$  orbitals cancel, leaving one  $\sigma$  and two  $\pi$  bonds – and thus a bond order of 3. Alternatively the bond order may be calculated using the formula (bonding – antibonding)/2, that is  $(10 - 4)/2 = 3$ . This simple picture is not adequate, since if CO is ionized to give  $\text{CO}^+$  by removal of one electron from the  $\sigma 2p_x$  orbital then the bond order should be reduced to  $2\frac{1}{2}$  and the bond length increased. In fact the bond length in CO is  $1.128 \text{ \AA}$  and in  $\text{CO}^+$  it is  $1.115 \text{ \AA}$ . Thus the bond length decreases when we expected it to increase, and it indicates that the electron must have been removed from an antibonding orbital. The problem remains if we assume

the order of energy for the MOs is the same as for atoms heavier than C, since this only reverses the position of the  $\sigma 2p_x$  and the ( $\pi 2p_y$ , and  $\pi 2p_z$ ) MOs. The most likely explanation of the bond shortening when CO is changed to  $\text{CO}^+$  is that the  $\sigma 2s$  and  $\sigma^* 2s$  molecular orbitals differ in energy more than is shown in the figure. This means that they are wider apart, and the  $\sigma^* 2s$  MO is higher in energy than the  $\sigma 2p_x$ ,  $\pi 2p_y$  and  $\pi 2p_z$  MOs. This illustrates very plainly that the order of MO energy levels for simple homonuclear diatomic molecules used above is not automatically applicable when two different types of atoms are bonded together, and it is certainly incorrect in this particular heteronuclear case.

#### HCl molecule

With heteronuclear atoms it is not obvious which AOs should be combined by the LCAO method to form MOs. In addition because the energy levels of the AOs on the two atoms are not identical, some MOs will contain a bigger contribution from one AO than the other. This is equivalent to saying that the MO 'bulges' more towards one atom, or the electrons in the MO spend more time round one atom than the other. Thus some degree of charge separation  $\delta+$  and  $\delta-$  occurs, resulting in a dipole. Thus partial ionic contributions may play a significant part in the bonding.

Consider the HCl molecule. Combination between the hydrogen  $1s$  AO and the chlorine  $1s$ ,  $2s$ ,  $2p$  and  $3s$  orbitals can be ruled out because their energies are too low. If overlap occurred between the chlorine  $3p_y$  and  $3p_z$  orbitals it would be non-bonding (see Figure 4.22) because the positive lobe of hydrogen will overlap equally with the positive and negative lobes of the chlorine orbitals. Thus the only effective overlap is with the chlorine  $3p_x$  orbital. The combination of  $\text{H } 1s^1$  and  $\text{Cl } 3p_x^1$  gives both bonding and antibonding orbitals, and the two electrons occupy the bonding MO, leaving the antibonding MO empty. It is assumed that all the chlorine AOs except  $3p_x$  are localized on the chlorine atom and retain their original AO status, and the  $3s$ ,  $3p_y$  and  $3p_z$  orbitals are regarded as non-bonding lone pairs.

This over-simplification ignores any ionic contribution such as can be shown with the valence bond resonance structures



The former would be expected to contribute significantly, resulting in a stronger bond.

#### EXAMPLES OF MOLECULAR ORBITAL TREATMENT INVOLVING DELOCALIZED $\pi$ BONDING

##### Carbonate ion $\text{CO}_3^{2-}$

The structure of the carbonate ion is a planar triangle, with bond angles of  $120^\circ$ . The C atom at the centre uses  $sp^2$  orbitals. All three oxygen atoms

are equivalent, and the C—O bonds are shorter than single bonds. A single valence bond structure such as that shown would have different bond lengths, and so fails to describe the structure adequately.

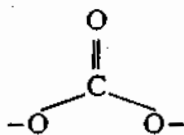

The problem is simply that an electron cannot be represented as a dot, or a pair of electrons as a line (bond). The fourth electron pair that makes up the double bond is not localized in one of the three positions, but is somehow spread out over all three bonds, so that each bond has a bond order of  $1\frac{1}{3}$ .

Pauling adapted the valence bond notation to cover structures where electrons are delocalized. Three contributing structures can be drawn for the carbonate ion:

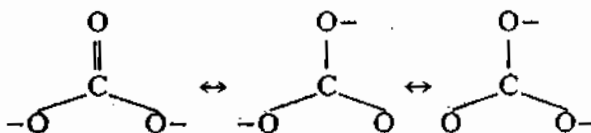

These contributing structures do not actually exist. The  $\text{CO}_3^{2-}$  does not consist of a mixture of these structures, nor is there an equilibrium between them. The true structure is somewhere in between, and is called a *resonance hybrid*. Resonance was widely accepted in the 1950s but is now regarded at best as clumsy and inadequate, and at worst as misleading or wrong!

Delocalized  $\pi$  bonding is best described by multi-centre bonds, which involve  $\pi$  molecular orbitals. The steps in working this out are:

1. Find the basic shape of the molecule or ion, either experimentally, or from the VSEPR theory using the number of  $\sigma$  bonds and lone pairs on the central atom.
2. Add up the total number of electrons in the outer (valence) shell of all the atoms involved, and add or subtract electrons as appropriate to form ions.
3. Calculate the number of electrons used in  $\sigma$  bonds and lone pairs, and by subtracting this from the total determine the number of electrons which can participate in  $\pi$  bonding.
4. Count the number of atomic orbitals which can take part in  $\pi$  bonding. Combine these to give the same number of molecular orbitals which are delocalized over all of the atoms. Decide whether MOs are bonding, non-bonding or antibonding, and feed the appropriate number of  $\pi$  electrons into the MOs (two electrons per MO). The orbitals with lowest energy are filled first. The number of  $\pi$  bonds formed can easily be determined from the MOs which have been filled.

The structure of the  $\text{CO}_3^{2-}$  will be examined in this way. There are 24 electrons in the valence shell (four from C, six from each of the three O atoms and two from the charges on the ion).

Of these, six are used to form the  $\sigma$  bonds between C and the three O atoms. Each O has four non-bonding electrons. This leaves six electrons available for  $\pi$  bonding.

The atomic orbitals available for  $\pi$  bonding are the  $2p_z$  orbital on C and the  $2p_z$  orbitals from the three O atoms. Combining these four atomic orbitals gives four four-centre  $\pi$  molecular orbitals. Each of these covers all four atoms in the ion. The lowest energy MO is bonding, the highest is antibonding, and the remaining two are non-bonding (and are also degenerate, i.e. the same in energy). The six  $\pi$  electrons occupy the MOs of lowest energy. Two electrons fill the bonding MO and four electrons fill both of the non-bonding MOs and thus contribute one  $\pi$  bond to the molecule. Each of the C—O bonds has a bond order of  $1\frac{1}{2}$ , 1 from the  $\sigma$  bond and  $\frac{1}{2}$  from the  $\pi$  bond.

#### Nitrate ion $\text{NO}_3^-$

The structure of the nitrate ion is a planar triangle. The N atom at the centre uses  $sp^2$  orbitals. All three oxygen atoms are equivalent, and the bond lengths N—O are all a little shorter than for a single bond. This cannot be explained by a valence bond structure:

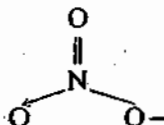

There 24 electrons in the valence shell (five from N, six from each of the three O atoms and one from the charge on the ion).

Of these, six are used to form the  $\sigma$  bonds between N and the three O atoms. Each O has four non-bonding electrons. This leaves six electrons available for  $\pi$  bonding.

The atomic orbitals used for  $\pi$  bonding are the  $2p_z$  orbitals on N and the three O atoms. Combining these four atomic orbitals gives four four-centre  $\pi$  molecular orbitals. The lowest in energy is bonding, the highest is antibonding, and the remaining two are degenerate (the same in energy) and are non-bonding. The six  $\pi$  electrons fill the bonding MO and both of the non-bonding MOs and thus contribute one  $\pi$  bond to the molecule. Each of the N—O bonds has a bond order of  $1\frac{1}{2}$ , 1 from the  $\sigma$  bond and  $\frac{1}{2}$  from the  $\pi$  bond.

#### Sulphur trioxide $\text{SO}_3$

The structure of  $\text{SO}_3$  is a planar triangle. The S atom at the centre uses  $sp^2$  orbitals. All three oxygen atoms are equivalent, and the S—O bonds are much shorter than single bonds. The valence bond structure is:

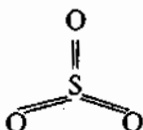

The multi-centre  $\pi$  MO explanation is as follows. There are 24 electrons in the valence shell (six from S and six from each of the three O atoms).

Of these, six are used to form the  $\sigma$  bonds between S and the three O atoms. Each O has four non-bonding electrons. This leaves six electrons available for  $\pi$  bonding.

$\text{SO}_3$  has 24 outer electrons like the  $\text{NO}_3^-$  ion. If  $\text{SO}_3$  followed the same pattern as the  $\text{NO}_3^-$  ion and used the  $3p_z$  AO on S and the  $2p_z$  AOs on the three O atoms, four MOs would be formed, one bonding, two non-bonding and one antibonding, and the six  $\pi$  electrons would occupy the bonding and non-bonding MOs, thus contributing one  $\pi$  bond to the molecule and giving a S—O bond order of  $1\frac{1}{2}$ . The bonds are much shorter than this would imply. Though  $\text{SO}_3$  has the same number of outer electrons as  $\text{NO}_3^-$ , the two are not isoelectronic. The S atom has three shells of electrons, so there is the possibility of using  $d$  orbitals in the bonding scheme.

The six atomic orbitals available for  $\pi$  bonding are the  $2p_z$  orbitals on the three O atoms and the  $3p_z$ ,  $3d_{xz}$  and  $3d_{yz}$  orbitals on S. Combining one  $2p_z$  AO with the  $3p_z$  AO gives two MOs, one bonding and the other antibonding. Similarly, combining the second  $2p_z$  AO with the  $3d_{xz}$  AO gives one bonding MO and one antibonding MO, and combining the third  $2p_z$  AO with the  $3d_{yz}$  AO gives one bonding MO and one antibonding MO. Thus we obtain three bonding MOs and three antibonding MOs. The six electrons available for  $\pi$  bonding occupy the three bonding MOs, and thus contribute three  $\pi$  bonds to the molecule. Each of the S—O bonds has a bond order of approximately 2, 1 from the  $\sigma$  bond and approximately 1 from the  $\pi$  bond. The reason why the bond order is approximate is that the extent of  $d$  orbital participation depends on the number of electrons and the size and energy of the orbitals involved. This involves detailed calculation.

### Ozone $\text{O}_3$

Ozone  $\text{O}_3$  forms a V-shaped molecule. Both bond lengths are 1.278 Å, and the bond angle is  $116^\circ 48'$ . We assume that the central O atom uses roughly  $sp^2$  orbitals for  $\sigma$  bonding. The valence bond representation of the structure is inadequate since it suggests that the bonds are of different lengths, though it could be explained in terms of resonance hybrids.

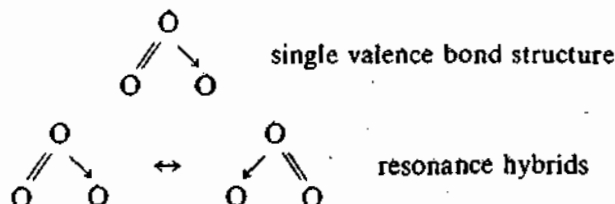

The double bonding in the structure is best explained by means of delocalized three-centre  $\pi$  bonding. There is a total of 18 electrons in the valence shell, made up of six from each of the three O atoms.

The central O atom forms a  $\sigma$  bond with each of the other O atoms, which accounts for four electrons. The central O atom uses  $sp^2$  orbitals, one of which is a lone pair. If the 'end' O atoms also use  $sp^2$  atomic orbitals, each O contains two non-bonding pairs of electrons. Thus lone pairs account for 10 electrons. Sigma bonds and lone pairs together account for 14 electrons, thus leaving four electrons for  $\pi$  bonding.

The atomic orbitals involved in  $\pi$  bonding are the  $2p_z$  orbitals on each of the three O atoms. These give rise to three molecular orbitals. These are three-centre  $\pi$  molecular orbitals. The lowest energy MO is bonding, the highest energy MO is antibonding, and the middle one is non-bonding. There are four  $\pi$  electrons and two fill the bonding MO and two fill the non-bonding MO, thus contributing one  $\pi$  bond over the molecule. This gives a bond order of 1.5 for the O—O bonds. The  $\pi$  system is thus a four-electron three-centre bond.

#### Nitrite ion $\text{NO}_2^-$

The nitrite ion  $\text{NO}_2^-$  is V-shaped. This is based on a plane triangular structure, with N at the centre, two corners occupied by O atoms, and the third corner occupied by a lone pair. Thus the N atom is roughly  $sp^2$  hybridised.

In the  $\text{NO}_2^-$  ion there are 18 electrons in the valence shell. These are made up of five from N, six from each of the two O atoms, and one from the charge on the ion.

The N atom forms  $\sigma$  bonds to each of the O atoms, which accounts for four electrons, and the N atom has a lone pair accounting for two electrons. If the O atoms also use  $sp^2$  atomic orbitals (one for bonding and two for lone pairs), the lone pairs on the O atoms account for eight more electrons. A total of 14 electrons has been accounted for, leaving four electrons for  $\pi$  bonding.

Three atomic orbitals are involved in  $\pi$  bonding: the  $2p_z$  orbitals on the N atom and on both of the O atoms. These three atomic orbitals form three molecular orbitals. These are three-centre  $\pi$  molecular orbitals. The lowest in energy is bonding, the highest is antibonding, and the middle one is non-bonding. Two of the four  $\pi$  electrons fill the bonding MO and two fill the non-bonding MO, thus contributing one  $\pi$  bond over the molecule. The bond order of the N—O bonds is thus 1.5, and the N—O distances are in between those for a single and double bond.

#### Carbon dioxide $\text{CO}_2$

The structure of  $\text{CO}_2$  is linear O—C—O, and the C atom uses  $sp$  hybrid orbitals for  $\sigma$  bonds. Both C—O bonds are the same length, but are much shorter than a single bond. This is best explained by delocalized  $\pi$  bonding

and involves multi-centre  $\pi$  molecular orbitals. The molecule contains 16 outer shell electrons, made up from six electrons from each of the two O atoms and four electrons from the C atom.

The C atom forms  $\sigma$  bonds to both the O atoms, thus accounting for four electrons. There are no lone pairs of electrons on the C atom. If the O atoms also use  $sp$  hybrid orbitals then there is one lone pair of electrons on each O atom, accounting for a further four electrons. This accounts for eight electrons altogether, leaving eight electrons available for  $\pi$  bonding.

If the  $\sigma$  bonding and lone pairs of electrons occupy the  $2s$  and  $2p_x$  atomic orbitals on each O atom, then the  $2p_y$  and  $2p_z$  atomic orbitals can be used for  $\pi$  bonding. Thus there are six atomic orbitals available for  $\pi$  bonding. The three  $2p_y$  atomic orbitals (one from C and one from each of the O atoms) form three three-centre  $\pi$  molecular orbitals which cover all three atoms. The MO with the lowest energy is called a bonding molecular orbital. The MO with the highest energy is called an antibonding MO, and the remaining MO is non-bonding. In a similar way, the three  $2p_z$  atomic orbitals also form bonding, non-bonding and antibonding three-centre  $\pi$  molecular orbitals. Each of these MOs covers all three atoms in the molecule. The eight  $\pi$  electrons occupy the MOs of lowest energy, in this case two electrons in the bonding  $2p_y$  MO, two electrons in the bonding  $2p_z$  MO, then two electrons in the non-bonding  $2p_y$  MO and two electrons in the non-bonding  $2p_z$  MO. This gives a net contribution of two  $\pi$  bonds to the molecule, in addition to the two  $\sigma$  bonds. Thus the bond order C—O is thus two.

#### Azide ion $N_3^-$

The  $N_3^-$  ion has 16 outer electrons (five from each N and one from the charge on the ion). It is isoelectronic with  $CO_2$ , and is linear N—N—N like  $CO_2$ . We assume the central N uses  $sp$  hybrid orbitals for  $\sigma$  bonding.

Four electrons are used for the two  $\sigma$  bonds. Each of the end N atoms has one non-bonding pair of electrons, accounting for four more electrons. This leaves eight electrons for  $\pi$  bonding.

If the bonding and non-bonding electrons are assumed to use the  $2s$  and  $2p_x$  orbitals, this leaves six atomic orbitals for  $\pi$  bonding. These are three  $2p_y$  AOs and three  $2p_z$  AOs. The three  $2p_y$  orbitals form three three-centre  $\pi$  molecular orbitals. The lowest in energy is bonding, the highest is antibonding, and the remaining MO is non-bonding. In a similar way the three  $2p_z$  atomic orbitals give bonding, non-bonding and antibonding MOs. The eight  $\pi$  electrons fill both of the bonding MOs, and both of the non-bonding MOs. Thus there are two  $\sigma$  and two  $\pi$  bonds, giving a bond order of 2. Thus both N—N bonds are the same length, 1.16 Å.

#### SUMMARY OF MULTI-CENTRE $\pi$ BONDED STRUCTURES

Isoelectronic species have the same shape and the same bond order (Table 4.6).

Table 4.6 Multi-centre bonded structures

Species	Number of outer electrons	Shape	Bond order
CO <sub>2</sub>	16	Linear	2
N <sub>3</sub>	16	Linear	2
O <sub>3</sub>	18	V-shaped	1.5
NO <sub>2</sub> <sup>-</sup>	18	V-shaped	1.5
CO <sub>3</sub> <sup>2-</sup>	24	Plane triangle	1.33
NO <sub>3</sub> <sup>-</sup>	24	Plane triangle	1.33

## UNITED ATOM METHOD

The LCAO method described above is tantamount to bringing the atoms from infinity to their equilibrium positions in the molecule. The united atom method is an alternative approach. It starts with a hypothetical 'united atom' where the nuclei are superimposed, and then moved to their equilibrium distance apart. The united atom has the same number of orbitals as a normal atom, but it contains the electrons from two atoms. Thus some electrons must be promoted to higher energy levels in the

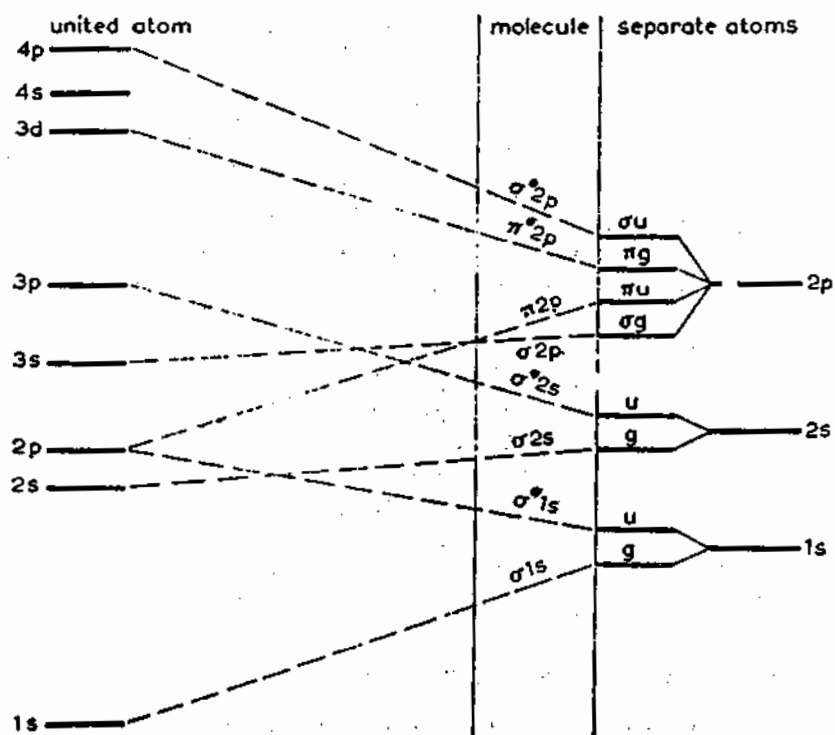

Figure 4.33 Mulliken correlation for like atoms forming a diatomic molecule.



united atom. Further, the energy of the united atom orbitals differs from that of the atomic orbitals because of the greater nuclear charge. Thus the molecular orbitals are in an intermediate position between the orbitals in the united atom and those in the separate atom. If lines are drawn between the energies of the electrons in the separate atoms and in the united atom (that is a graph of internal energy against the distance between the nuclei from  $r = 0$  to  $r = \infty$ ), a correlation diagram is obtained (Figure 4.33).

#### FURTHER READING

- Atkins, P.W. (1983) *Molecular Quantum Mechanics*, Oxford University Press, Oxford.
- Ballhausen, C.J. and Gray, H.B. (1964) *Molecular Orbital Theory*, Benjamin, Menlo Park, California.
- Ballhausen, C.J. and Gray, H.B. (1980) *Molecular Electronic Structures*, Benjamin-Cummings, Menlo Park, California.
- Brown, I.D. (1978) A simple structural model for inorganic chemistry, *Chem. Soc. Rev.*, 7, 359.
- Burdett, J.K. (1980) *Molecular Shapes: Theoretical Models for Inorganic Stereochemistry*, Wiley-Interscience, New York.
- Cartmell, E. and Fowles, G.W.A. (1977) *Valency and Molecular Structure*, 4th ed., Butterworths, London.
- Coulson, C.A. (1982) revised by McWeeny, R., *The Shape and Structure of Molecules*, 2nd ed., Clarendon Press, Oxford.
- Coulson, C.A. (1979) revised by McWeeny, R., *Valence*, 3rd ed., Oxford University Press, Oxford. (An updated version of Coulson's 1969 book.)
- DeKock, R.L. and Bosma, W.B. (1988) The three-center, two-electron chemical bond; *J. of Chem. Ed.*, 65, 194–197.
- DeKock, R.L. and Gray, H.B. (1980) *Chemical Structure and Bonding*, Benjamin/Cummings, Menlo Park, California.
- Douglas, B., McDaniel, D.H. and Alexander J.J. (1983) *Concepts and Models in Inorganic Chemistry*, 2nd ed., Wiley, New York.
- Ebsworth, E.A.V., Rankin, D.W.H. and Craddock, S. (1987) *Structural Methods in Inorganic Chemistry*, Blackwell Scientific, Oxford.
- Ferguson, J.E. (1974) *Stereochemistry and Bonding in Inorganic Chemistry*, Prentice Hall, Englewood Cliffs, N.J.
- Gillespie, R.J. (1972) *Molecular Geometry*, Van Nostrand Reinhold, London. (The latest on the VSEPR theory.)
- Gillespie, R.J. and Nyholm, R.S. (1957) *Q. Rev. Chem. Soc.*, 11, 339. (Develops the Sidgwick–Powell theory into the modern VSEPR theory.)
- Karplus, M. and Porter, R.N. (1970) *Atoms and Molecules*, Benjamin, New York.
- Kettle, S.F.A. (1985) *Symmetry and Structure*, Wiley, London.
- Kutzelnigg, W. (1984) Chemical bonding in higher main group elements, *Angew. Chemie* (International edition in English), 23, 272.
- Murrell, J.N., Kettle, S.F.A. and Tedder, J.M. (1985) *The Chemical Bond*, 2nd ed., Wiley, London.
- O'Dwyer, M.F., Kent, J.E. and Brown, R.D. (1978) *Valency*, 2nd ed., Springer (reprinted 1986).
- Pauling, L. (1961) *The Nature of the Chemical Bond*, 3rd ed., Oxford University Press, Oxford. (A classical text on bonding.)
- Pauling, L. (1967) *The Chemical Bond*, Oxford University Press, Oxford. (A shorter and updated book on bonding.)
- Sidgwick, N.V. and Powell H.M. (1940) *Proc. R. Soc.*, 176A, 153. (The original paper on electron pair repulsion theory.)

- Speakman, J.C. (1977) *Molecular Structure: Its Study by Crystal Diffraction*, Royal Society for Chemistry, Monographs for Teachers 30.
- Urch, D.S. (1970) *Orbitals and Symmetry*, Penguin.
- Wade, K. (1971) *Electron Deficient Compounds*, Nelson, London.
- Worral, J. and Worral I.J. (1969) *Introduction to Valence Theory*, American Elsevier Publishing Co., New York.

Bond lengths and bond angles of molecular structures in the crystalline and gaseous states are given in The Chemical Society's Special Publication 11 (*Interatomic Distances*) and Special Publication 18 (*Interatomic Distances Supplement*).

### PROBLEMS

1. Show by drawings how an  $s$  orbital, a  $p$  orbital or a  $d$  orbital on one atom may overlap with  $s$ ,  $p$  or  $d$  orbitals of an adjacent atom.
2. List three rules for the linear combination of atomic orbitals.
3. Show how the LCAO approximation gives rise to bonding and anti-bonding orbitals. Illustrate your answer by reference to three different diatomic molecules.
4. Use the molecular orbital theory to explain why the bond strength in a  $N_2$  molecule is greater than that in a  $F_2$  molecule.
5. Use the MO theory to predict the bond order and the number of unpaired electrons in  $O_2^{2-}$ ,  $O_2^-$ ,  $O_2$ ,  $O_2^+$ , NO and CO.
6. Draw MO energy level diagrams for  $C_2$ ,  $O_2$  and CO. Show which orbitals are occupied, and work out the bond orders and magnetic properties of these molecules.
7. Name the three types of hybrid orbital that may be formed by an atom with only  $s$  and  $p$  orbitals in its valence shell. Draw the shapes and stereochemistry of the hybrid orbitals so produced.
8. What are the geometric arrangements of  $sp^3d^2$ ,  $sp^3d$  and  $dsp^2$  hybrid orbitals?
9. Predict the structure of each of the following, and indicate whether the bond angles are likely to be distorted from the theoretical values: (a)  $BeCl_2$ ; (b)  $BCl_3$ ; (c)  $SiCl_4$ ; (d)  $PCl_5$  (vapour); (e)  $PF_3$ ; (f)  $F_2O$ ; (g)  $SF_4$ ; (h)  $IF_5$ ; (i)  $SO_2$ ; (j)  $SF_6$ .
10. How and why does the cohesive force in metals change on descending a group, or on moving from one group to another? What physical properties follow these changes in cohesive force?
11. Use energy level diagrams and the band theory to explain the difference between conductors, insulators and semiconductors.

# The metallic bond

5

## GENERAL PROPERTIES OF METALS

All metals have characteristic physical properties:

1. They are exceptionally good conductors of electricity and heat.
2. They have a characteristic metallic lustre – they are bright, shiny and highly reflective.
3. They are malleable and ductile.
4. Their crystal structures are almost always cubic close-packed, hexagonal close-packed, or body-centred cubic.
5. They form alloys readily.

### Conductivity

All metals are exceptionally good conductors of heat and electricity. Electrical conduction arises by the movement of electrons. This is in contrast to the movement of ions which is responsible for conduction in aqueous solution or fused melts of ionic compounds like sodium chloride, where sodium ions migrate to the cathode, and chloride ions migrate to the anode. In the solid state, ionic compounds may conduct to a very small extent (semiconduction) if defects are present in the crystal. There is an enormous difference in the conductivity between metals and any other type of solid (Table 5.1).

Table 5.1 Electrical conductivity of various solids

Substance	Type of bonding	Conductivity (ohm cm <sup>-1</sup> )
Silver	Metallic	$6.3 \times 10^5$
Copper	Metallic	$6.0 \times 10^5$
Sodium	Metallic	$2.4 \times 10^5$
Zinc	Metallic	$1.7 \times 10^5$
Sodium chloride	Ionic	$10^{-7}$
Diamond	Covalent giant molecule	$10^{-14}$
Quartz	Covalent giant molecule	$10^{-14}$

Most of the elements to the left of carbon in the periodic table are metals. A carbon atom has four outer electrons. If these are all used to form four bonds, the outer shell is complete and there are no electrons free to conduct electricity.

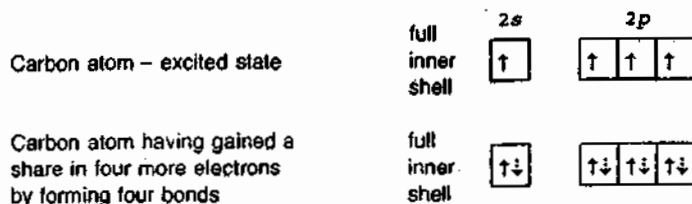

Elements to the left of carbon have fewer electrons, and so they must have vacant orbitals. Both the number of electrons present in the outer shell, and the presence of vacant orbitals in the valence shell, are important features in explaining the conductivity and bonding of metals.

The conductivity of metals decreases with increasing temperature. Metals show some degree of paramagnetism, which indicates that they possess unpaired electrons.

### Lustre

Smooth surfaces of metals typically have a lustrous shiny appearance. All metals except copper and gold are silvery in colour. (Note that when finely divided most metals appear dull grey or black.) The shininess is rather special, and is observed at all viewing angles, in contrast to the shininess of a few non-metallic elements such as sulphur and iodine which appear shiny when viewed at low angles. Metals are used as mirrors because they reflect light at all angles. This is because of the 'free' electrons in the metal, which absorb energy from light and re-emit it when the electron drops back from its excited state to its original energy level. Since light of all wavelengths (colours) is absorbed, and is immediately re-emitted, practically all the light is reflected back – hence the lustre. The reddish and golden colours of copper and gold occur because they absorb some colours more readily than others.

Many metals emit electrons when exposed to light – the photoelectric effect. Some emit electrons when irradiated with short-wave radiation, and others emit electrons on heating (thermionic emission).

### Malleability and cohesive force

The mechanical properties of metals are that they are typically malleable and ductile. This shows that there is not much resistance to deformation of the structure, but that a large cohesive force holds the structure together.

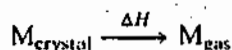

Table 5.2 Enthalpies of atomization  $\Delta H^\circ$  ( $\text{kJ mol}^{-1}$ ) (Measured at 25°C except for Hg)

Metal	$\Delta H^\circ$	Melting point. (°C)	Boiling point (°C)
Li	162	181	1331
Na	108	98	890
K	90	64	766
Rb	82	39	701
Cs	78	29	685
Be	324	1277	2477
Mg	146	650	1120
Ca	178	838	1492
Sr	163	768	1370
Ba	178	714	1638
B	565	2030	3927
Al	326	660	2447
Ga	272	30	2237
Sc	376	1539	2480
Ti	469	1668	3280
V	562	1900	3380
Cr	397	1875	2642
Mn	285	1245	2041
Fe	415	1537	2887
Co	428	1495	2887
Ni	430	1453	2837
Cu	339	1083	2582
Zn	130	420	908

Enthalpies of atomization from Brewer, L., *Science*, 1968, 161, 115, with some additions.

The cohesive force may be measured as the heat of atomization. Some numerical values of  $\Delta H^\circ$ , the heats of atomization at 25°C, are given in Table 5.2. The heats of atomization (cohesive energy) decrease on descending a group in the periodic table Li-Na-K-Rb-Cs, showing that they are inversely proportional to the internuclear distance.

The cohesion energy increases across the periodic table from Group I to Group II to Group III. This suggests that the strength of metallic bonding is related to the number of valency electrons. The cohesive energy increases at first on crossing the transition series Sc-Ti-V as the number of unpaired *d* electrons increases. Continuing across the transition series the number of electrons per atom involved in metallic bonding eventually falls, as the *d* electrons become paired, reaching a minimum at Zn.

The melting points and to an even greater extent the boiling points of the metals follow the trends in the cohesive energies. The cohesive energies vary over an appreciable range, and they approach the magnitude of the lattice energy which holds ionic crystals together. The cohesive

energies are much larger than the weak van der Waals forces which hold discrete covalent molecules together in the solid state.

There are two rules about the cohesive energy and structure of metals (or alloys), and these are examined below:

*Rule 1. The bonding energy of a metal depends on the average number of unpaired electrons available for bonding on each atom.*

*Rule 2. The crystal structure adopted depends on the number of  $s$  and  $p$  orbitals on each atom that are involved with bonding.*

Consider the first rule – Group I metals have the outer electronic configuration  $ns^1$ , and so have one electron for bonding. In the ground state (lowest energy), Group II elements have the electronic configuration  $ns^2$ , but if the atom is excited, an outer electron is promoted, giving the configuration  $ns^1, np^1$ , with two unpaired electrons, which can form two bonds. Similarly Group III elements in the ground state have the configuration  $ns^2, np^1$ , but when excited to  $ns^1, np^2$ , they can use three electrons for metallic bonding.

The second rule attempts to relate the number of  $s$  and  $p$  electrons available for bonding to the crystal structure adopted (Table 5.3). Apart from Group I metals, the atoms need to be excited, and the structures adopted are shown in Table 5.4.

**Table 5.3** Prediction of metal structures from the number of  $s$  and  $p$  electrons involved in metallic bonding

Number of $s$ and $p$ electrons per atom involved in bonding	Structure
Less than 1.5	Body-centred cubic
1.7–2.1	Hexagonal close-packed
2.5–3.2	Cubic close-packed
Approaching 4	Diamond structure – not metallic

Group I elements have a body-centred cubic structure, and follow the rule. In Group II, only Be and Mg have a hexagonal close-packed structure and strictly follow the rule. In Group III, Al has a cubic close-packed structure as expected. However, not all the predictions are correct. There is no obvious reason why Ca and Sr form cubic close-packed structures. However, the high temperature forms of Ca and Sr, and the room temperature form of Ba form body-centred cubic structures (like Group I), instead of the expected hexagonal close-packed structure. The explanation is probably that the paired  $s$  electron is excited to a  $d$  level instead of a  $p$  level, and hence there is only one  $s$  or  $p$  electron per atom participating in metallic bonding. This also explains why the first half of the transition metals also form body-centred cubic structures. In the second half of the transition series, the extra electrons may be put in the  $p$  level, to avoid

**Table 5.4** Type of structure adopted by metals in the periodic table (The room temperature structure is shown at the bottom. Other structures which occur at higher temperatures are listed above this in order of temperature stability)

Li bcc	Be hcp												B	C	N	
Na bcc	Mg hcp												Al ccp	Si d	P	S
K bcc	Ca bcc ccp	Sc bcc hcp	Ti bcc hcp	V bcc	Cr bcc	Mn bcc ccp $\beta$ $\chi$	Fe bcc ccp bcc	Co ccp hcp	Ni ccp	Cu ccp	Zn hcp		Ga •	Ge d	As • $\alpha$	Se
Rb bcc	Sr bcc hcp ccp	Y bcc hcp	Zr bcc hcp	Nb bcc	Mo bcc	Tc hcp	Ru hcp	Rh ccp	Pd ccp	Ag ccp	Cd hcp	In ccp*	Sn d	Sb • $\alpha$	Te	
Cs bcc	Ba bcc	La bcc ccp hcp	Hf bcc hcp	Ta bcc	W bcc	Re hcp	Os hcp	Ir ccp	Pt ccp	Au ccp	Hg	Tl bcc hcp	Pb ccp	Bi • $\alpha$	Po	

bcc = body-centred cubic  
 ccp = cubic close-packed  
 ccp\* = distorted cubic close-packed  
 hcp = hexagonal close-packed

d = diamond structure  
 $\alpha$  = rhombohedral - puckered sheets  
 $\chi$  = other structure  
 • = special case (see individual group)

pairing  $d$  electrons, and so allow the maximum participation of  $d$  orbitals in metallic bonding. This increases the number of  $s$  and  $p$  electrons involved in metallic bonding, and for example in Cu, Ag and Au the excited electronic state involved in bonding is probably  $d^8, s^1, p^2$ , giving a cubic close-packed structure and five bonds per atom (two  $d$ , one  $s$  and two  $p$  electrons). At Zn the  $d$  orbitals are full, and the excited state used for bonding is  $3d^{10}, 4s^1, 4p^1$ , giving two bonds per atom and a body-centred cubic structure. The enthalpies of atomization are in general agreement with these ideas on bonding.

### Crystal structures of metals

Metallic elements usually have a close-packed structure with a coordination number of 12. There are two types of close packing depending on the arrangement of adjacent layers in the structure: cubic close packing ABCABC and hexagonal close packing ABAB (see Metallic bonds and metallic structures in Chapter 2). However, some metals have a body-centred cubic type of structure (which fills the space slightly less efficiently) where there are eight nearest neighbours, with another six next-nearest neighbours about 15% further away. If this small difference in distance between nearest and next-nearest neighbours is disregarded, the coordination number for a body-centred cubic structure may be regarded loosely as 14. The mechanical properties of malleability and ductility depend on the ease with which adjacent planes of atoms can glide over each other, to give an equivalent arrangement of spheres. These properties are also affected by physical imperfections such as grain boundaries and dislocations, by point defects in the crystal lattice and by the presence of traces of impurity in the lattice. The possibility of planes gliding is greatest in cubic close-packed structures, which are highly symmetrical and have possible slip planes of close-packed layers in four directions (along the body diagonals), compared with only one direction in the hexagonal close-packed structure. This explains why cubic close-packed structures are generally softer and more easily deformed than hexagonal or body-centred cubic structures. Impurities may cause dislocations in the normal metal lattice, and the localized bonding increases the hardness. Some soft metals like Cu become work hardened – it is harder to bend the metal a second time. This is because dislocations are caused by the first bending, and these disrupt the slip planes. Other metals such as Sb and Bi are brittle. This is because they have directional bonds, which pucker layers, preventing one layer from slipping over another.

The type of packing varies with the position of the element in the periodic table (Table 5.4), which is related to the number of  $s$  and  $p$  electrons on each atom that can take part in metallic bonding. This has been described earlier.

Metallic elements commonly react with other metallic elements, often over a wide range of composition, forming a variety of alloys which look like metals, and have the properties of metals.



**Table 5.5** Interatomic distances in  $M_2$  molecules and metal crystals

	Distance in metal (Å)	Distance in $M_2$ molecule (Å)
Li	3.04	2.67
Na	3.72	3.08
K	4.62	3.92
Rb	4.86	4.22
Cs	5.24	4.50

**Bond lengths**

If the valence electrons in a metal are spread over a large number of bonds, each bond should be weaker and hence longer. The alkali metals exist as diatomic molecules in the vapour state, and the interatomic distances in the metal crystal are longer than in the diatomic molecule (Table 5.5).

Though the bonds in the metal are longer and weaker, there are many more of them than in the  $M_2$  molecule, so the total bonding energy is greater in the metal crystal. This can be seen by comparing the enthalpy of sublimation of the metal crystal with the enthalpy of dissociation of the  $M_2$  molecules (Table 5.6).

**THEORIES OF BONDING IN METALS**

The bonding and structures adopted by metals and alloys are less fully understood than those with ionic and covalent compounds. Any successful theory of metallic bonding must explain both the bonding between a large number of identical atoms in a pure metal, and the bonding between widely different metal atoms in alloys. The theory cannot involve directional bonds, since most metallic properties remain even when the metal is in the liquid state (for example mercury), or when dissolved in a suitable

**Table 5.6** Comparison of enthalpies of sublimation and dissociation

	Enthalpy of sublimation of metal ( $\text{kJ mol}^{-1}$ )	$\frac{1}{2}$ enthalpy of dissociation of $M_2$ molecule ( $\text{kJ mol}^{-1}$ )
Li	161	54
Na	108	38
K	90	26
Rb	82	24
Cs	78	21

solvent (for example solutions of sodium in liquid ammonia). Further, the theory should explain the great mobility of electrons.

### Free electron theory

As early as 1900, Drude regarded a metal as a lattice with electrons moving through it in much the same way as molecules of a gas are free to move. The idea was refined by Lorentz in 1923, who suggested that metals comprised a lattice of rigid spheres (positive ions), embedded in a gas of free valency electrons which could move in the interstices. This model explains the free movement of electrons, and cohesion results from electrostatic attraction between the positive ions and the electron cloud. Whilst it does explain in a rough qualitative way why an increased number of valency electrons results in an increased cohesive energy, quantitative calculations are much less successful than similar calculations for the lattice energies of ionic compounds.

### Valence bond theory

Consider a simple metal such as lithium, which has a body-centred cubic structure, with eight nearest neighbours and six next-nearest neighbours at a slightly greater distance. A lithium atom has one electron in its outer shell, which may be shared with one of its neighbours, forming a normal two-electron bond. The atom could equally well be bonded to any of its other eight neighbours, so many different arrangements are possible, and Figures 5.1a and b are two examples.

A lithium atom may form two bonds if it ionizes, and it can then form many structures similar to those in Figures 5.1c and d. Pauling suggested that the true structure is a mixture of all the many possible bonding forms. The more possible structures there are, the lower the energy. This means that the cohesive force which holds the structure together is large, and in metallic lithium the cohesive energy is three times greater than in a  $\text{Li}_2$  molecule. The cohesive energy increases from Group I to II to III, and this is explained by the atoms being able to form an increased number of bonds, and give an even larger number of possible structures. The presence of ions could explain the electrical conduction, but the theory does not explain the conduction of heat in solids, or the lustre, or the retention of metallic properties in the liquid state or in solution.

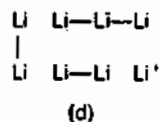
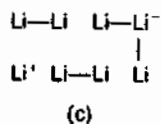
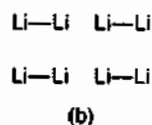
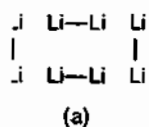

1 Representations of bonding possibilities in

### Molecular orbital or band theory

The electronic structure of a lithium atom is

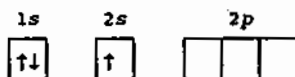

The  $\text{Li}_2$  molecule exists in the vapour state, and bonding occurs using the  $2s$  atomic orbital. There are three empty  $2p$  orbitals in the valence shell, and the presence of empty AOs is a prerequisite for metallic properties. (Carbon in its excited state, nitrogen, oxygen, fluorine, and neon all lack empty AOs in the valence shell and are all non-metals.)

The valence shell has more AOs than electrons, so even if the electrons are all used to form normal two-electron bonds, the atom cannot attain a noble gas structure. Compounds of this type are termed 'electron deficient'.

Empty AOs may be utilized to form additional bonds in two different ways:

1. Empty AOs may accept lone pairs of electrons from other atoms or ligands, forming coordinate bonds.
2. Cluster compounds may be formed, where each atom shares its few electrons with several of its neighbours, and obtains a share in their electrons. Clustering occurs in the boron hydrides and carboranes, and is a major feature of metals.

The molecular orbital description of an  $\text{Li}_2$  molecule has been discussed earlier in Chapter 4, in the examples of MO treatment. There are six electrons arranged in molecular orbitals:

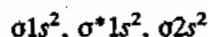

Bonding occurs because the  $\sigma 2s$  bonding MO is full and the corresponding antibonding orbital is empty. Ignoring any inner electrons, the  $2s$  AOs on each of the two Li atoms combine to give two MOs – one bonding and one antibonding. The valency electrons occupy the bonding MO (Figure 5.2a).

Suppose three Li atoms joined to form  $\text{Li}_3$ . Three  $2s$  AOs would combine to form three MOs – one bonding, one non-bonding and one antibonding. The energy of the non-bonding MO is between that for the bonding and antibonding orbitals. The three valency electrons from the three atoms would occupy the bonding MO (two electrons) and the non-bonding MO (one electron) (Figure 5.2b).

In  $\text{Li}_4$ , the four AOs would form four MOs – two bonding, and two antibonding. The presence of two non-bonding MOs between the bonding and antibonding orbitals reduces the energy gap between the orbitals. The four valency electrons would occupy the two lowest energy MOs, which are both bonding orbitals, as shown in Figure 5.2c.

As the number of electrons in the cluster increases, the spacing between the energy levels of the various orbitals decreases further, and when there are a large number of atoms, the energy levels of the orbitals are so close together that they almost form a continuum (Figure 5.2d).

The number of MOs must by definition be equal to the number of constituent AOs. Since there is only one valence electron per atom in lithium, and a MO can hold two electrons, it follows that only half the MOs in the  $2s$  valence band are filled – i.e. the bonding MOs. It requires

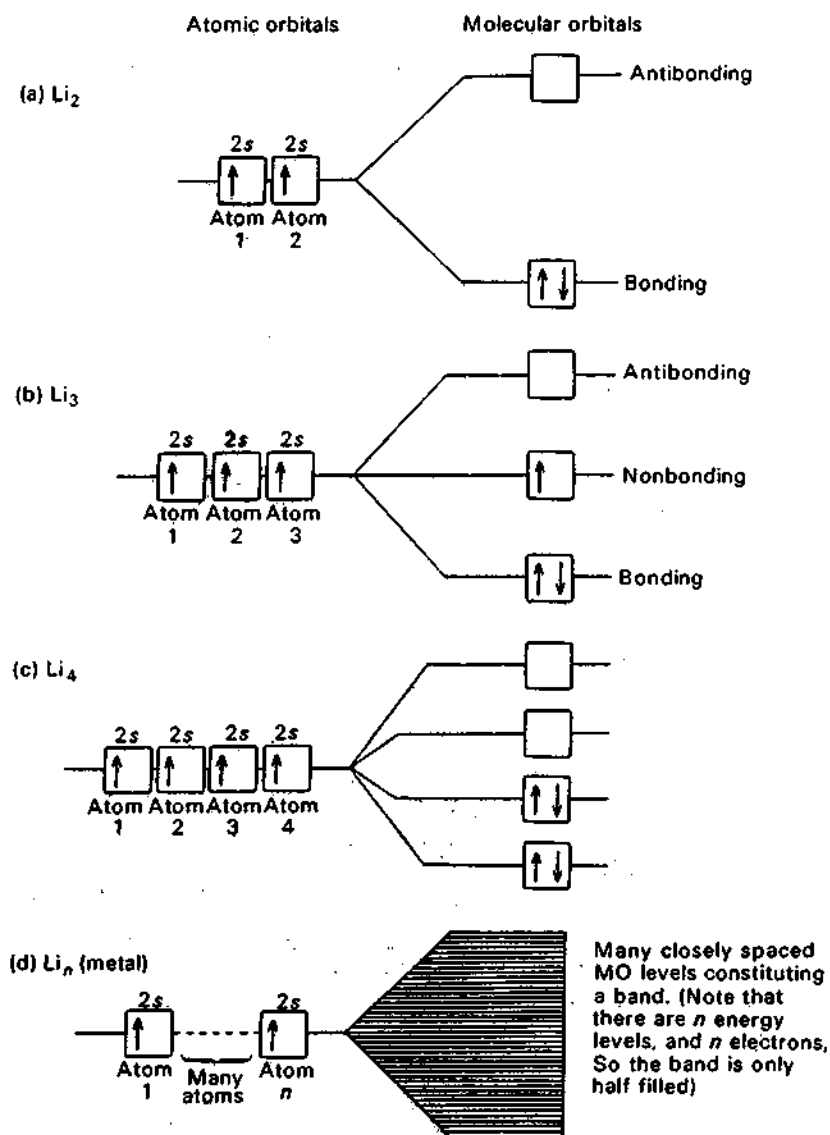

Figure 5.2 Development of molecular orbitals into bands in metals.

only a minute amount of energy to perturb an electron to an unoccupied MO.

The MOs extend in three dimensions over all the atoms in the crystal, so electrons have a high degree of mobility. The mobile electrons account for the high thermal and electrical conduction of metals.

If one end of a piece of metal is heated, electrons at that end gain energy and move to an unoccupied MO where they can travel rapidly to any other part of the metal, which in turn becomes hot. In an analogous manner, electrical conduction takes place through a minor perturbation in energy

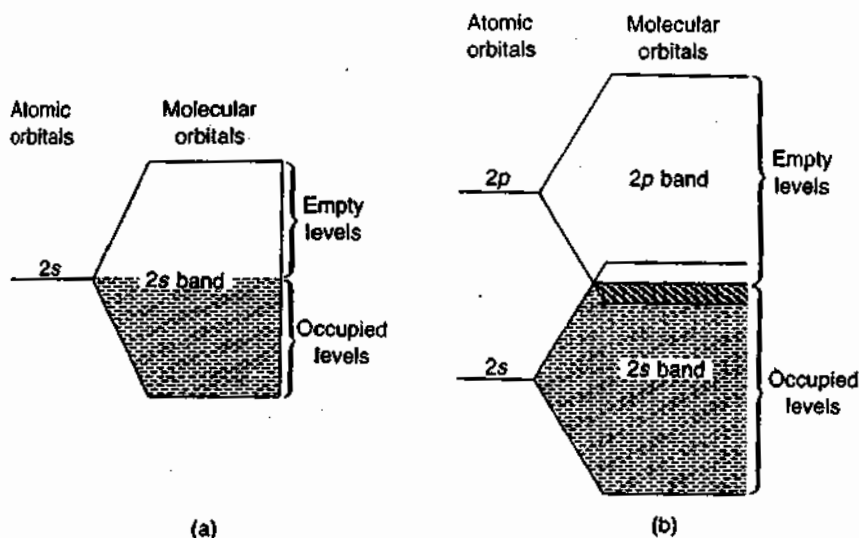

Figure 5.3 Two methods by which conduction can occur: (a) metallic molecular orbitals for lithium showing half filled band; (b) metallic molecular orbitals for beryllium showing overlapping bands.

promoting an electron to an unfilled level, where it can move readily. In the absence of an electric field, equal numbers of electrons will move in all directions. If a positive electrode is placed at one end, and a negative electrode at the other, then electrons will move towards the anode much more readily than in the opposite direction; hence an electric current flows.

Conduction occurs because the MOs extend over the whole crystal, and because there is effectively no energy gap between the filled and unfilled MOs. The absence of an energy gap in lithium is because only half the MOs in the valence band are filled with electrons (Figure 5.3a).

In beryllium there are two valence electrons, so the valence electrons would just fill the 2s valence band of MOs. In an isolated beryllium atom, the 2s and 2p atomic orbitals differ in energy by  $160 \text{ kJ mol}^{-1}$ . In much the same way as the 2s AOs form a band of MOs, the 2p AOs form a 2p band of MOs. The upper part of the 2s band overlaps with the lower part of the 2p band (Figure 5.3b). Because of this overlap of the bands some of the 2p band is occupied and some of the 2s band is empty. It is both possible and easy to perturb electrons to an unoccupied level in the conduction band, where they can move throughout the crystal. Beryllium therefore behaves as a metal. It is only because the bands overlap that there is no energy gap, so perturbation from the filled valence band to the empty conduction band can occur.

## CONDUCTORS, INSULATORS AND SEMICONDUCTORS

In electrical conductors (metals), either the valence band is only partly full, or the valence and conduction bands overlap. There is therefore no

significant gap between filled and unfilled MOs, and perturbation can occur readily.

In insulators (non-metals), the valence band is full, so perturbation within the band is impossible, and there is an appreciable difference in energy (called the band gap) between the valence band and the next empty band. Electrons cannot therefore be promoted to an empty level where they could move freely.

Intrinsic semiconductors are basically insulators, where the energy gap between adjacent bands is sufficiently small for thermal energy to be able to promote a small number of electrons from the full valence band to the empty conduction band. Both the promoted electron in the conduction band and the unpaired electron left in the valence band can conduct electricity. The conductivity of semiconductors increases with temperature, because the number of electrons promoted to the conduction band increases as the temperature increases. Both *n*-type and *p*-type semiconductors are produced by doping an insulator with a suitable impurity. The band from the impurity lies in between the valence and conduction bands in the insulator, and acts as a bridge, so that electrons may be excited from the insulator bands to the impurity bands, or vice versa (Figure 5.4). (Defects and semiconductors are discussed at the end of Chapter 3.)

## ALLOYS

When two metals are heated together, or a metal is mixed with a non-metallic element, then one of the following will occur:

1. An ionic compound may be formed.
2. An interstitial alloy may be formed.
3. A substitutional alloy may be formed.
4. A simple mixture may result.

Which of these occurs depends on the chemical nature of the two elements concerned, and on the relative sizes of the metal atoms and added atoms.

### Ionic compounds

Consider first the chemical nature of the two elements. If an element of high electronegativity (e.g. F 4.0, Cl 3.0 or O 3.5) is added to a metal of low electronegativity (e.g. Li 1.0, Na 0.9), the product will be ionic, not metallic.

### Interstitial alloys and related compounds

Next consider the relative sizes of the atoms. The structure of many metals is a close-packed lattice of spherical atoms or ions. There are therefore many tetrahedral and octahedral holes. If the element added has small atoms, they can be accommodated in these holes without altering the

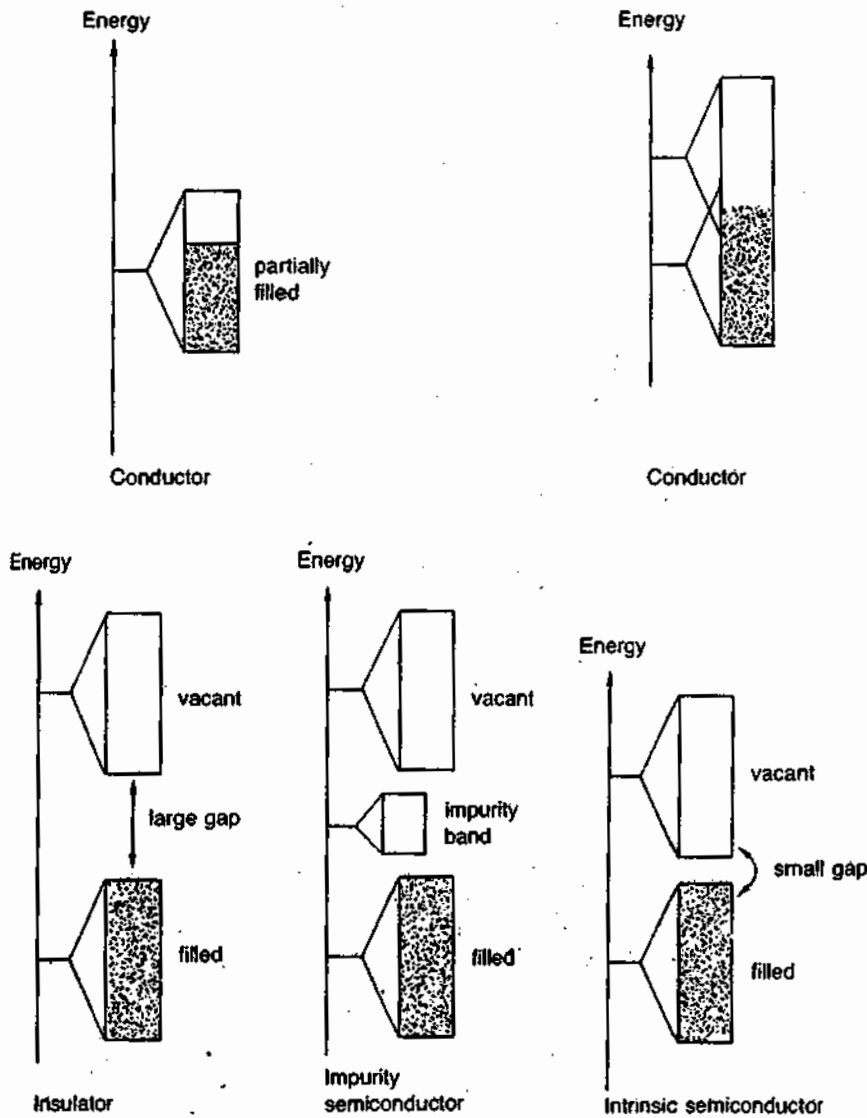

Figure 5.4 Conductors, insulators, impurity and intrinsic semiconductors.

structure of the metal. Hydrogen is small enough to occupy tetrahedral holes, but most other elements occupy the larger octahedral holes.

The invading atoms occupy interstitial positions in the metal lattice, instead of replacing the metal atoms. The chemical composition of compounds of this type may vary over a wide range depending on how many holes are occupied. Such alloys are called interstitial solid solutions, and are formed by a wide range of metals with hydrogen, boron, carbon, nitrogen and other elements. The most important factor is the size of the invading atoms. For octahedral holes to be occupied, the radius ratio of

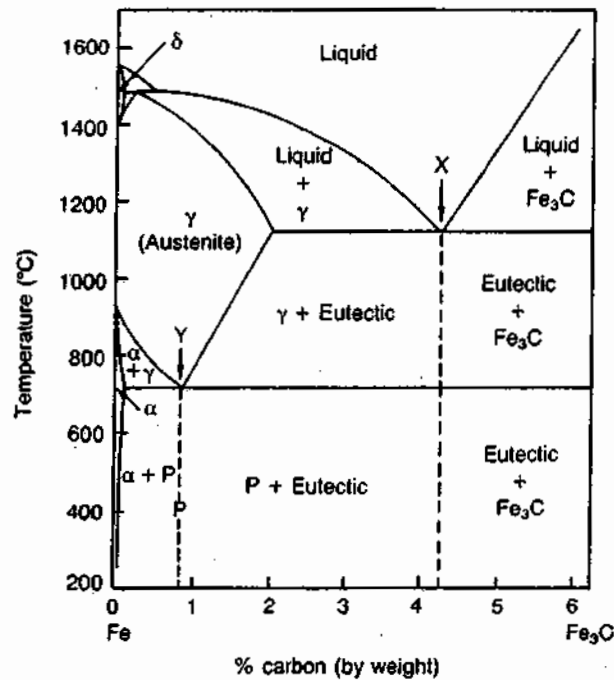

Figure 5.5 Part of the iron-carbon phase diagram (X = eutectic, Y = eutectoid, P = pearlite).

the smaller atom/larger atom should be in the range 0.414–0.732. The invasion of interstitial sites does not significantly alter the metal structure. It still looks like a metal, and still conducts heat and electricity. However, filling some of the holes has a considerable effect on the physical properties, particularly the hardness, malleability and ductility of the metal. This is because filling holes makes it much more difficult for one layer of metal ions to slip over another.

Interstitial borides, carbides and nitrides are extremely inert chemically, have very high melting points, and are extremely hard. Interstitial carbides of iron are of great importance in the various forms of steel.

The iron-carbon phase diagram is of great importance in the ferrous metal industry, and part of this is shown in Figure 5.5. The most important part is from pure Fe to the compound iron carbide or cementite,  $\text{Fe}_3\text{C}$ . Pure Fe exists as two allotropic forms: one is  $\alpha$ -ferrite or austenite, with a body-centred cubic structure, which is stable up to  $910^\circ\text{C}$ ; above this temperature it changes to  $\gamma$ -ferrite with a face centred-cubic structure. Above  $1401^\circ\text{C}$   $\gamma$ -ferrite changes back to a body-centred cubic structure, but is now called  $\delta$ -ferrite.

The upper part of the curve is typical of two solids which are only partly miscible, and a eutectic point occurs at X, between  $\gamma$ -ferrite, iron carbide and liquid. A similar triple point occurs at Y, but since it occurs in a completely solid region it is called a eutectoid point. A solid with the



eutectoid composition (a mixture of  $\gamma$ -ferrite and iron carbide) is called pearlite. This is a mixture, not a compound, and is marked P in the diagram. The name pearlite refers to the mother-of-pearl-like appearance when examined under a microscope. The various solid regions  $\alpha$ ,  $\gamma$ ,  $\delta$  are the different allotropic forms of iron and all contain varying amounts of carbon in interstitial positions.

Steel contains up to 2% carbon. The more carbon present, the harder and more brittle the alloy. When steel is heated, the solid forms austenite, which can be hot rolled, bent or pressed into any required shape. On cooling, the phases separate, and the way in which the cooling is carried out affects the grain size and the mechanical properties. The properties of steel can be changed by heat treatment such as annealing and tempering.

Cast iron contains more than 2% carbon. Iron carbide is extremely hard, and brittle. Heating cast iron does not produce a homogeneous solid solution (similar to austenite for steel), so cast iron cannot be worked mechanically, and the liquid must be cast into the required shape.

### Substitutional alloys

If two metals are completely miscible with each other they can form a continuous range of solid solutions. Examples include Cu/Ni, Cu/Au, K/Rb, K/Cs and Rb/Cs. In cases like these, one atom may replace another at random in the lattice.

In the Cu/Au case at temperatures above 450°C a disordered structure exists (Figure 5.7c), but on slow cooling the more ordered superlattice may be formed (Figure 5.7d). Only a few metals form this type of continuous solid solution, and Hume-Rothery has shown that for complete miscibility the following three rules should apply.

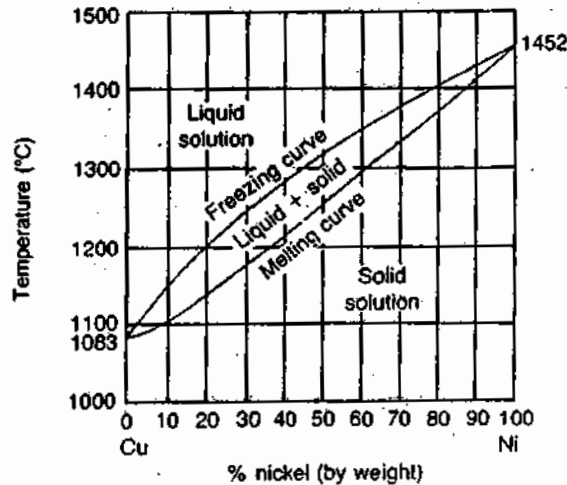

Figure 5.6 Cu/Ni – a continuous series of solid solutions. (After W.J. Moore, *Physical Chemistry*.)

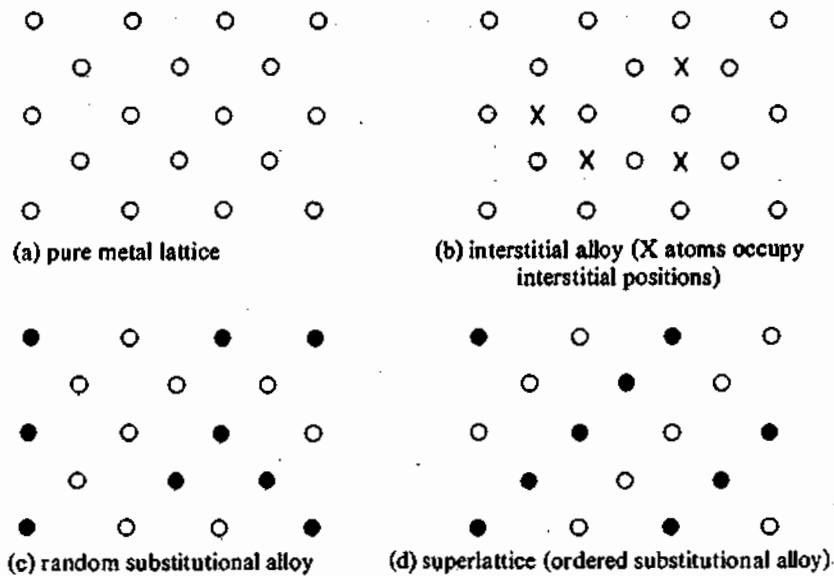

Figure 5.7 Metal and alloy structures: (a) pure metal lattice; (b) interstitial alloy (X atoms occupy interstitial positions); (c) random substitutional alloy and (d) superlattice (ordered substitutional alloy).

1. The two metals must be similar in size – their metallic radii must not differ by more than 14–15%.
2. Both metals must have the same crystal structure.
3. The chemical properties of the metals must be similar – in particular the number of valency electrons should be the same.

Consider an alloy of Cu and Au. The metallic radii differ by only 12.5%, both have cubic close-packed structures, and both have similar properties since they are in the same vertical group in the periodic table. The two metals are therefore completely miscible. The Group I elements are chemically similar, and all have body-centred cubic structures. The size differences between adjacent pairs of atoms are Li–Na 22.4%, Na–K 22.0%, K–Rb 9.3% and Rb–Cs 6.9%. Because of the size difference, complete miscibility is found with K/Rb and Rb/Cs alloys, but not with Li/Na and Na/K alloys.

If only one *or* two of these rules is satisfied then random substitutional solid solutions will only occur over a very limited range at the two extremes of composition.

Consider alloys of tin and lead. The radii differ by only 8.0%, and they are both in Group IV, and so have similar properties. However, their structures are different, so they are only partly miscible. (See Figure 5.8.) Solder is an alloy of Sn and Pb with typically about 30% Sn, but it may have 2–63% Sn. The phase diagram is shown in Figure 5.8. There are two small areas of complete miscibility, labelled  $\alpha$  and  $\beta$ , at the extremes of composition at the extreme left and right of the diagram. With plumbers'

**Table 5.7** Metallic radii of the elements (Å) (for 12-coordination)

Li	Be												B	C	N	
1.52	1.12												0.89	0.91	0.92	
Na	Mg												Al	Si	P	S
1.86	1.60												1.43	1.32	1.28	1.27
K	Ca	Sc	Ti	V	Cr	Mn	Fe	Co	Ni	Cu	Zn		Ga	Ge	As	Se
2.27	1.97	1.64	1.47	1.35	1.29	1.37	1.26	1.25	1.25	1.28	1.37		1.23	1.37	1.39	1.40
Rb	Sr	Y	Zr	Nb	Mo	Tc	Ru	Rh	Pd	Ag	Cd		In	Sn	Sb	Te
2.48	2.15	1.82	1.60	1.47	1.40	1.35	1.34	1.34	1.37	1.44	1.52		1.67	1.62	1.59	1.60
Cs	Ba	La	Hf	Ta	W	Re	Os	Ir	Pt	Au	Hg		Tl	Pb	Bi	Po
2.65	2.22	1.87	1.59	1.47	1.41	1.37	1.35	1.36	1.39	1.44	1.57		1.70	1.75	1.70	1.76

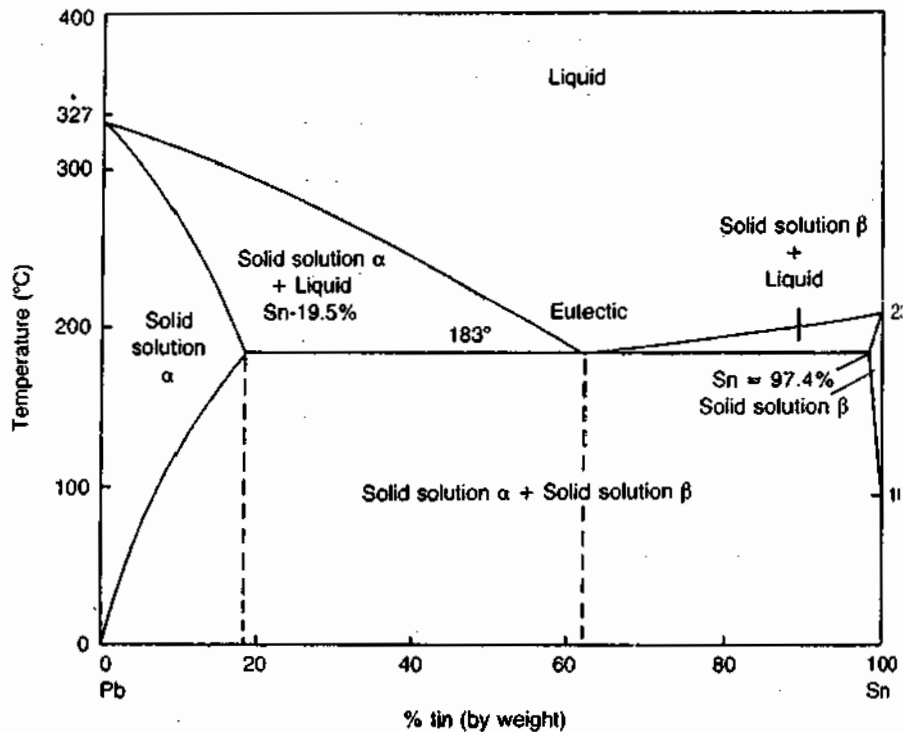

**Figure 5.8** Phase diagram for Sn/Pb showing partial miscibility, and only a limited range of solid solutions. (The eutectic occurs at 62% Sn, and eutectoid points occur at 19.5% Sn and 97.4% Sn.)

solder (30% Sn, 70% Pb), the liquid and solid curves are far apart, so that there is a temperature interval of nearly 100°C over which the solder is pasty, with solid solution suspended in liquid. When in this part-solid part-liquid state, a solder joint can be 'wiped' smooth.

Similar behaviour is found with the Na/K alloy, and the Al/Cu alloy. The metallic radii of Na and K differ by 22.0%, so despite their structural and chemical similarities they only form solid solutions over a limited range of composition.

In other cases where only a limited range of solid solutions are formed, the tendency of the different metals to form compounds instead of solutions is important. One or more intermetallic phases may exist, each of which behaves as a compound of the constituent metals, though the exact stoichiometry may vary over a limited range. For example, in the Cu/Zn system the metallic radii differ by only 7.0%, but they have different structures (Cu is cubic close-packed and Zn is hexagonal close-packed), and they have a different number of valence electrons. Only a limited range of solid solutions is expected, but the atoms have a strong tendency to form compounds, and five different structures may be distinguished, as shown in Table 5.8.

Table 5.8 Table of intermetallic phases

Phase	Zn Composition	Structure
$\alpha$	0–35%	Random substitutional solid solution of Zn in Cu
$\beta$	45–50%	Intermetallic compound of approximate stoichiometry CuZn. Structure body-centred cubic
$\gamma$	60–65%	Intermetallic compound of approximate stoichiometry Cu <sub>5</sub> Zn <sub>8</sub> . Structure complex cubic
$\epsilon$	82–88%	Intermetallic compound of approximate stoichiometry CuZn <sub>3</sub> . Structure hexagonal close-packed
$\eta$	97–100%	Random substitutional solid solution of Cu in Zn

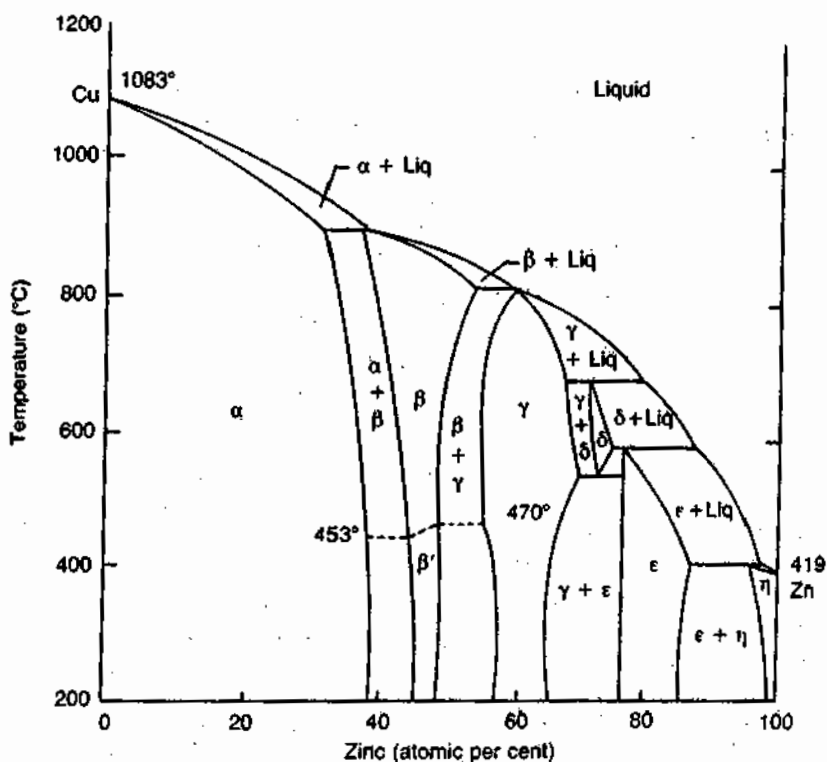

Figure 5.9 Phase diagram for Cu/Zn alloy systems. (Copyright Böhm and Klemm, *Z. Anorg. Chem.*, 243, 69, 1939.)

**Table 5.9** Some intermetallic compounds with various ratios of valency electrons to number of atoms

Ideal formula	No. of valency electrons	
	No. of atoms	
CuZn	3/2	} $\beta$ phases
Cu <sub>3</sub> Al	6/4 = 3/2	
Cu <sub>5</sub> Sn	9/6 = 3/2	
AgZn	3/2	
Cu <sub>5</sub> Si	9/6 = 3/2	
Ag <sub>3</sub> Al	6/4 = 3/2	
CoZn <sub>3</sub>	3/2*	} $\gamma$ phases
Cu <sub>5</sub> Zn <sub>8</sub>	21/13	
Cu <sub>9</sub> Al <sub>4</sub>	21/13	
Na <sub>31</sub> Pb <sub>8</sub>	21/13	
Co <sub>5</sub> Zn <sub>21</sub>	21/13*	} $\epsilon$ phases
CuZn <sub>3</sub>	7/4	
Cu <sub>3</sub> Si	7/4	
Ag <sub>5</sub> Al <sub>3</sub>	14/8 = 7/4	
Au <sub>5</sub> Al <sub>3</sub>	14/8 = 7/4	

\* Metals of the Fe, Co and Ni groups are assumed to have zero valence electrons for metallic bonding.

The relation between the various phases is shown in the phase diagram (Figure 5.9). Each phase can be represented by a typical composition or ideal formula, even though it exists over a range of composition. Hume-Rothery studied the compositions of the phases formed and found that the  $\beta$  phase always occurs in alloys when the ratio of the sum of the valency electrons to the number of atoms is 3:2. In a similar way the  $\gamma$  phase always occurs when the ratio is 21:13, and the  $\eta$  phase always occurs when the ratio is 7:4, irrespective of the particular metals involved (Table 5.9).

The explanation of why similar binary metallic phases are formed at similar electron to atom ratios is not fully understood, but seems to lie in filling the electronic bands in such a way as to give the minimum energy.

### SUPERCONDUCTIVITY

Metals are good conductors of electricity, and their conductivity increases as the temperature is lowered. In 1911 the Dutch scientist Heike Kamerlingh Onnes discovered that metals such as Hg and Pb became superconductors at temperatures near absolute zero. A superconductor has zero or almost zero electrical resistance. It can therefore carry an electric current without losing energy, and in principle the current can flow for ever. There is a critical temperature  $T_c$  at which the resistance drops sharply and superconduction occurs. Later, Meissner and Ochsenfeld found that some superconducting materials will not permit a magnetic field to penetrate

their bulk. This is now called the Meissner effect, and gives rise to 'levitation'. Levitation occurs when objects float on air. This can be achieved by the mutual repulsion between a permanent magnet and a superconductor. A superconductor also expels all internal magnetic fields (arising from unpaired electrons), so superconductors are diamagnetic. In many cases the change in magnetic properties is easier to detect than the increased electrical conductivity, since the passage of high currents or strong magnetic fields may destroy the superconductive state. Thus there is also a critical current and critical magnetization which are linked to  $T_c$ .

A superconducting alloy of niobium and titanium, which has a  $T_c$  of about 4 K and requires liquid helium to cool it, has been known since the 1950s. Considerable effort has been put into finding alloys which are superconductors at higher temperatures. Alloys of  $Nb_3Sn$ ,  $Nb_3Ge$ ,  $Nb_3Al$  and  $V_3Si$  all show superconductivity and have  $T_c$  values of about 20 K. It is interesting that these alloys all have the same  $\beta$ -tungsten structure. The  $Nb_3Sn$  and  $Nb_3Ge$  alloys have  $T_c$  values of 22 K and 24 K respectively. These alloys are used to make the wire for extremely powerful electromagnets. These magnets have a variety of uses:

1. In linear accelerators used as atom smashers for high energy particle physics research
2. In nuclear fusion research to make powerful magnetic fields which act as a magnetic bottle for a plasma
3. For military purposes
4. For nuclear magnetic resonance imaging (which is used in diagnostic medicine).

An extremely high current can be passed through a very fine wire made of a superconductor. Thus small coils with a large number of turns can be used to make extremely powerful high field electromagnets. Because the superconductor has effectively zero resistance, the wire does not get hot. Since there is no current loss, once the current is flowing in the coil it continues indefinitely. For example, in large superconducting magnets used in plasma research, the current used by a Nb/Ta superconducting alloy at 4 K was only 0.3% of the current used in an electromagnet of similar power using copper wire for the metal turns. A major obstacle to the widespread use of these *low temperature superconductors* has been the very low value of the transition temperature  $T_c$ . The only way of attaining these low temperatures was to use liquid helium, which is very expensive.

The first non-metallic superconductor was found in 1964. This was a metal oxide with a perovskite crystal structure and is a different type of superconductor from the alloys. It was of no practical use since the  $T_c$  is only 0.01 K.

The perovskite structure is formed by compounds of formula  $ABO_3$ , where the oxidation states of A and B add up to 6. Examples include  $BaTiO_3$ ,  $CaTiO_3$  and  $NaNbVO_3$ . The perovskite crystal structure is cubic. A  $Ca^{2+}$  ion is located at the body-centred position (at the centre of the cube), the smaller  $Ti^{4+}$  ions are located at each corner, and the  $O^{2-}$  are

located half-way along each of the edges of the cube. Thus the  $\text{Ca}^{2+}$  has a coordination number of 12 since it is surrounded by 12 O atoms, and the  $\text{Ti}^{4+}$  are surrounded octahedrally by 6 O atoms. This structure is illustrated in Figure 19.2.

Superconductivity has also been observed in certain organic materials with flat molecules stacked on top of each other, and in certain sulphides called Chevrel compounds.

In 1986 Georg Bednorz and Alex Müller (who were working for IBM in Zurich, Switzerland) reported a new type of superconductor with a  $T_c$  value of 35 K. This temperature was appreciably higher than that for the alloys. This compound is a mixed oxide in the Ba-La-Cu-O system. Though originally given a different formula, it has now been reformulated as  $\text{La}_{(2-x)}\text{Ba}_x\text{CuO}_{(4-y)}$  where  $x$  is between 0.15 and 0.20 and  $y$  is small. This compound has a perovskite structure based on  $\text{La}_2\text{CuO}_4$ . Though  $\text{La}_2\text{CuO}_4$  itself is non-conducting, superconductors can be made by replacing 7.5–10% of the  $\text{La}^{3+}$  ions by  $\text{Ba}^{2+}$ . There is a small deficiency of  $\text{O}^{2-}$ . It seems reasonable that the oxygen loss from the lattice is balanced by the reduction of an easily reducible metal cation, in this case  $\text{Cu}^{3+}$ .

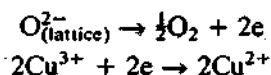

The publication of this paper stimulated enormous interest in 'ceramic' superconductors and a flood of papers was published in 1987. Different laboratories prepared similar compounds, replacing  $\text{Ba}^{2+}$  with  $\text{Ca}^{2+}$  or  $\text{Sr}^{2+}$ , substituting different lanthanides, and varying the preparative conditions to control the amount of oxygen. In the main syntheses stoichiometric quantities of the appropriate metal oxides or carbonates are heated in air, cooled, ground, heated in oxygen and annealed. Compounds were made with  $T_c$  values of about 50 K. Bednorz and Müller were awarded the Nobel Prize for Physics in 1987.

Another very significant superconducting system based on the Y-Ba-Cu-O system was reported in March 1987 by Wu, Chu and coworkers. This was important because it was the first report of a superconductor which worked at 93 K. This temperature was significant for practical reasons. It allows liquid nitrogen (boiling point 77 K) to be used as coolant rather than the more expensive liquid helium. The compound is formulated as  $\text{YBa}_2\text{Cu}_3\text{O}_{7-x}$ . This is called the 1-2-3 system because of the ratio of the metals present. Like the previous  $\text{La}_2\text{CuO}_4$  system, the 1-2-3 structure contains Cu and is based on a perovskite structure. This comprises three cubic perovskite units stacked one on top of the other, giving an elongated (tetragonal) unit cell.

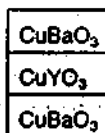



The upper and lower cubes have a  $\text{Ba}^{2+}$  ion at the body-centred position and the smaller  $\text{Cu}^{2+}$  ions at each corner. The middle cube is similar but has a  $\text{Y}^{3+}$  ion at the body centre. A perovskite structure has the formula  $\text{ABO}_3$ , and the stoichiometry of this compound would be  $\text{YBa}_2\text{Cu}_3\text{O}_9$ . Since the formula actually found is  $\text{YBa}_2\text{Cu}_3\text{O}_{7-x}$ , there is a massive oxygen deficiency, and about one quarter of the oxygen sites in the crystal are vacant. In a perovskite cube,  $\text{O}^{2-}$  are located half-way along each of the 12 edges of the cube. Neutron diffraction shows that the O vacancies are ordered. All the O which should be present at the same height up the z axis as the Y atom are absent; half of the O atoms around Cu and between the Ba planes are also missing.

Several lanthanides, including Sm, Eu, Nd, Dy and Yb, have been substituted for Y in 1-2-3 structures. Values of  $T_c$  up to 93 K are well established. These are called *warm superconductors*.

In 1988 new systems were reported using Bi or Tl instead of the lanthanides. For example, in the system  $\text{Bi}_2\text{Sr}_2\text{Ca}_{(n-1)}\text{Cu}_n\text{O}_{(2n+4)}$  compounds are known where  $n$  is 1, 2, 3 and 4. These all have a perovskite structure and have  $T_c$  values of 12 K, 80 K, 110 K and 90 K respectively. A similar range of compounds  $\text{Tl}_2\text{Ba}_2\text{Ca}_{(n-1)}\text{Cu}_n\text{O}_{(2n+4)}$  are known with  $T_c$  values of 90 K, 110 K, 122 K and 119 K respectively. There are claims that the compound  $\text{Bi}_{1.7}\text{Pb}_{0.2}\text{Sb}_{0.1}\text{Sr}_2\text{Ca}_2\text{Cu}_{2.8}\text{O}_y$  has a  $T_c$  value of 164 K.

$\text{BaBiO}_3$  has a perovskite structure, but is not a superconductor. However, replacing some of the Ba sites with K, or replacing some of the Bi sites with Pb, gives other superconducting phases such as  $\text{K}_x\text{Ba}_{(1-x)}\text{BiO}_3$  and  $\text{BaPb}_{(1-x)}\text{Bi}_x\text{O}_3$ . These compounds have relatively low  $T_c$  values, but are of theoretical interest because they do not contain Cu or a lanthanide element.

The race to discover superconductors which work at higher temperatures continues. The prospect of making superconductors which work at room temperature will continue to attract attention, since its technical applications have great financial benefits. What are these potential uses?

1. The possibility of power transmission using a superconductor is highly attractive. There are obvious difficulties about making long cables from a ceramic material. However, low loss transmission of DC through resistanceless cables from electricity generating power stations rather than AC through normal wire is economically attractive.
2. Use in computers. One of the biggest difficulties in further miniaturization of computer chips is how to get rid of unwanted heat. If superconductors were used, the heat problems would be dramatically reduced. The greater speed of chips is hindered by the time it takes to charge a capacitor, due to the resistance of the interconnecting metal film. Superconductors could lead to faster chips.
3. Powerful electromagnets using superconducting windings are already used. It would be much easier to do this at higher temperatures.
4. Levitation - much pioneering work was done by Eric Laithwaite at

Imperial College on linear motors, and a prototype of a train which floats on a magnetic field has been built in Japan.

Superconductivity of metals and alloys is thought to involve two electrons at a time (Bardeen *et al.*, 1957; Ogg, 1946). There is no one accepted explanation of how high temperature superconduction occurs in these mixed oxide (ceramic) systems. However, it seems appropriate to draw together the apparent facts at this time:

1. Many, but not all, warm superconductors *contain Cu*. Two features of Cu chemistry are that it exists in three oxidation states, (+I), (+II) and (+III), and that Cu(II) forms many tetragonally distorted octahedral complexes. Both of these factors may be important. In the  $\text{La}_2\text{CuO}_4$  compounds some  $\text{Ba}^{2+}$  ions are substituted for  $\text{La}^{3+}$ . To balance the charges some Cu(II) atoms change into Cu(III). Superconductivity in this system is thought to involve the transfer of electrons from Cu(II) to Cu(III), but if the process involves two electrons as in the metal superconductors it could involve electron transfer from Cu(I) to Cu(III).
2. It is also significant that *these superconductors are all related to the perovskite structure*.
3. Another common feature is that *the oxygen deficiency seems to be critical*. There is strong evidence from neutron diffraction that the vacancies left by missing O are ordered. It seems reasonable to suppose that, since Cu is normally octahedrally surrounded by six O atoms, when an O vacancy occurs (that is when an O is omitted), then two Cu atoms may interact directly with each other. Interactions such as  $\text{Cu}^{\text{II}}-\text{Cu}^{\text{III}}$  or  $\text{Cu}^{\text{I}}-\text{Cu}^{\text{III}}$  could occur by transferring an electron between the two Cu atoms. Similarly superconductivity in the  $\text{YBa}_2\text{Cu}_3\text{O}_{7-x}$  is thought to be associated with the ready transfer of electrons between Cu(I), Cu(II) and Cu(III).

#### FURTHER READING

- Adams, D.M. (1974) *Inorganic Solids*, Wiley, New York.
- Addison, C.C. (1974) The chemistry of liquid metals, *Chemistry in Britain*, **10**, 331.
- Brewer, L. (1968) *Science*, **161**, 115. (Enthalpies of atomisation.)
- Burdett, J.K. (1982) New ways to look at solids, *Acc. Chem. Res.*, **15**, 34.
- Chemistry in Britain*, May 1969 - The whole issue is devoted to metals and alloys.
- Cox, P.A. (1987) *The Electronic Structure and Chemistry of Solids*, Oxford University Press, Oxford.
- Duffy, J.A. (1983) Band theory of conductors, semiconductors and insulators, *Education in Chemistry*, **20**, 14-18.
- Galwey, A.K. (1967) *Chemistry of Solids*, Chapman Hall, London.
- Ho, S.M. and Douglas, B.E. (1972) Structures of the elements and the PTOT system, *J. Chem. Ed.*, **49**, 74.
- Hume-Rothery, W. (1964) Review of bonding in metals, *Metallurgist*, **3**, 11.
- Hume-Rothery, W. (1964) A note on the intermetallic chemistry of the later transition elements, *J. Less-Common Metals*, **7**, 152.
- Hume-Rothery, W.J. and Raynor, G.V. (1962) *The Structure of Metals and Alloys*, 4th ed., Institute of Metals, London.

- Hume-Rothery, W.J., Christian, J.W. and Pearson, W.B. (1952) *Metallurgical Equilibrium Diagrams*, Institute of Physics, London.
- Jolly, W.L. (1976) *The Principles of Inorganic Chemistry*, (Chapter 11: Metals; Chapter 12: Semiconductors), McGraw Hill, New York.
- Metal Structures Conference (Brisbane 1983), (ISBN 0-85825-183-3). Gower Publishing Company.
- Parish, R.V. (1976) *The Metallic Elements*, Longmans, London.
- Parish, R.V. (1976) *The Metallic Elements*, Longmans, London.

### Superconductivity

- Bardeen, J., Cooper, L.N. and Schreiffer, J.R. (1957) *Phys. Rev.*, **106**, 162. (Development of the BCS theory of superconductivity in metals arising from the movement of electron pairs.)
- Bednorz, J.G. and Müller, A. (1986) Possible high  $T_c$  superconductivity in the Ba-La-Cu-O system, *Z. Phys.*, **B.**, **64**, 189. (The paper which started interest in metal oxide superconductors.)
- Edwards, P.P., Harrison, M.R. and Jones, R. (1987) Superconductivity returns to chemistry, *Chemistry in Britain*, **23**, 962-966.
- Ellis, A.B. (1987) Superconductors, *J. Chem. Ed.*, **64**, 836-841.
- Khurana, A. (1989) *Physics Today*, April, 17-19.
- Murray Gibson, J. (1987) Superconducting ceramics, *Nature*, **329**, 763.
- Ogg, R.A. (1946) *Phys. Rev.*, **69**, 243. (First suggestion that superconduction in alloys is by electron pairs.)
- Sharp, J.H. (1990) A review of the crystal chemistry of mixed oxide superconductors, *Br. Ceram. Trans. J.*, **89**, 1-7. (An understandable review of warm superconductors which attempts to relate properties and structure - the best so far.)
- Tilley, D.R. and Tilley, J. (1986) *Superfluidity and Superconductivity*, 2nd ed., Hilger, Bristol.
- Wu, M.K. *et al.*, (1987) Superconductivity at 93 K in a new mixed phase Y-Ba-Cu-O compound system at ambient pressure, *Phys. Rev. Lett.*, **58**, 908-910.

### PROBLEMS

1. List the physical and chemical properties associated with metals.
2. Name and draw the three common crystal structures adopted by metals.
3. Aluminium has a face-centred cubic structure. The unit cell length is 4.05 Å. Calculate the radius of Al in the metal. (Answer: 1.43 Å.)
4. Explain why the electrical conductivity of a metal decreases as the temperature is raised, but the opposite occurs with semiconductors.
5. Describe the structures of interstitial and substitutional alloys and outline the factors determining which is formed.
6. What is superconductivity? What uses and potential uses are there for superconductors? What types of materials are superconductors?

# 6

## General properties of the elements

### SIZE OF ATOMS AND IONS

#### Size of atoms

The size of atoms decreases from left to right across a period in the periodic table. For example, on moving from lithium to beryllium one extra positive charge is added to the nucleus, and an extra orbital electron is also added. Increasing the nuclear charge results in all of the orbital electrons being pulled closer to the nucleus. In a given period, the alkali metal is the largest atom and the halogen the smallest. When a horizontal period contains ten transition elements the contraction in size is larger, and when in addition there are 14 inner transition elements in a horizontal period, the contraction in size is even more marked.

On descending a group in the periodic table such as that containing lithium, sodium, potassium, rubidium and caesium, the sizes of the atoms increase due to the effect of extra shells of electrons being added: this outweighs the effect of increased nuclear charge.

#### Size of ions

Metals usually form positive ions. These are formed by removing one or more electrons from the metal atom. Metal ions are smaller than the atoms from which they were formed for two reasons:

1. The whole of the outer shell of electrons is usually ionized, i.e. removed. This is one reason why cations are much smaller than the original metal atom.
2. A second factor is the effective nuclear charge. In an atom, the number of positive charges on the nucleus is exactly the same as the number of orbital electrons. When a positive ion is formed, the number of positive charges on the nucleus exceeds the number of orbital electrons, and the effective nuclear charge (which is the ratio of the number of charges on the nucleus to the number of electrons) is increased. This results in the remaining electrons being more strongly attracted by the nucleus. Thus the electrons are pulled in – further reducing the size.

Table 6.1 Covalent radii of the elements

Group Period	I	II											III	IV	V	VI	VII	0	
1	H • ~0.30																	H • ~0.30	He • 1.20*
2	Li • 1.23	Be • 0.89											B • 0.80	C • 0.77	N • 0.74	O • 0.74	F • 0.72	Ne • 1.60*	
3	Na • 1.57	Mg • 1.36											Al • 1.25	Si • 1.17	P • 1.10	S • 1.04	Cl • 0.99	Ar • 1.91*	
4	K • 2.03	Ca • 1.74	Sc • 1.44	Ti • 1.32	V • 1.22	Cr • 1.17	Mn • 1.17	Fe • 1.17	Co • 1.16	Ni • 1.15	Cu • 1.17	Zn • 1.25	Ga • 1.25	Ge • 1.22	As • 1.21	Se • 1.14	Br • 1.14	Kr • 2.00*	
5	Rb • 2.16	Sr • 1.91	Y • 1.62	Zr • 1.45	Nb • 1.34	Mo • 1.29	Tc • -	Ru • 1.24	Rh • 1.25	Pd • 1.28	Ag • 1.34	Cd • 1.41	In • 1.50	Sn • 1.40	Sb • 1.41	Te • 1.37	I • 1.33	Xe • 2.20*	
6	Cs • 2.35	Ba • 1.98	La • 1.69	Hf • 1.44	Ta • 1.34	W • 1.30	Re • 1.28	Os • 1.26	Ir • 1.26	Pt • 1.29	Au • 1.34	Hg • 1.44	Tl • 1.55	Pb • 1.46	Bi • 1.52	Po	At	Rn	
7	Fr	Ra	Ac																
Lanthanides			Ce • 1.65	Pr • 1.64	Nd • 1.64	Pm • -	Sm • 1.66	Eu • 1.85	Gd • 1.61	Tb • 1.59	Dy • 1.59	Ho • 1.58	Er • 1.57	Tm • 1.56	Yb • 1.70	Lu • 1.56			

COVALENT RADII OF THE ELEMENTS

(Numerical values are given in Ångström units. \* The values for the noble gases are atomic radii, i.e. non-bonded radii, and should be compared with van der Waals radii rather than with covalent bonded radii. Large circles indicate large radii and small circles small radii.)

After Moeller, T., *Inorganic Chemistry*, Wiley 1952

A positive ion is always smaller than the corresponding atom, and the more electrons which are removed (that is, the greater the charge on the ion), the smaller the ion becomes.

Metallic radius Na	1.86 Å	Atomic radius Fe	1.17 Å
Ionic radius Na <sup>+</sup>	1.02 Å	Ionic radius Fe <sup>2+</sup>	0.780 Å (high spin)
		Ionic radius Fe <sup>3+</sup>	0.645 Å (high spin)

When a negative ion is formed, one or more electrons are added to an atom, the effective nuclear charge is reduced and hence the electron cloud expands. Negative ions are bigger than the corresponding atom.

Covalent radius Cl	0.99 Å
Ionic radius Cl <sup>-</sup>	1.84 Å

### Problems with ionic radii

There are several problems in obtaining an accurate set of ionic radii.

1. Though it is possible to measure the internuclear distances in a crystal very accurately by X-ray diffraction, for example the distance between Na<sup>+</sup> and F<sup>-</sup> in NaF, there is no universally accepted formula for apportioning this to the two ions. Historically several different sets of ionic radii have been estimated. The main ones are by Goldschmidt, Pauling and Ahrens. These are all calculated from observed internuclear distances, but differ in the method used to split the distance between the ions. The most recent values, which are probably the most accurate, are by Shannon (1976).
2. Corrections to these radii are necessary if the charge on the ion is changed.
3. Corrections must also be made for the coordination number, and the geometry.
4. The assumption that ions are spherical is probably true for ions from the *s*- and *p*-blocks with a noble gas configuration, but is probably untrue for transition metal ions with an incomplete *d* shell.
5. In some cases there is extensive delocalization of *d* electrons, for example in TiO where they give rise to metallic conduction, or in cluster compounds. This also changes the radii.

Thus ionic radii are not absolute constants, and are best seen as a working approximation.

### Trends in ionic radii

Irrespective of which set of ionic radii are used, the following trends are observed:

1. In the main groups, radii increase on descending the group, e.g. Li<sup>+</sup> = 0.76 Å, Na<sup>+</sup> = 1.02 Å, K<sup>+</sup> = 1.38 Å, because extra shells of electrons are added.

- The ionic radii decrease moving from left to right across any period in the periodic table, e.g.  $\text{Na}^+ = 1.02 \text{ \AA}$ ,  $\text{Mg}^{2+} = 0.720 \text{ \AA}$  and  $\text{Al}^{3+} = 0.535 \text{ \AA}$ . This is partly due to the increased number of charges on the nucleus, and also to the increasing charge on the ions.
- The ionic radius decreases as more electrons are ionized off, that is as the valency increases, e.g.  $\text{Cr}^{2+} = 0.80 \text{ \AA}$  (high spin),  $\text{Cr}^{3+} = 0.615 \text{ \AA}$ ,  $\text{Cr}^{4+} = 0.55 \text{ \AA}$ ,  $\text{Cr}^{5+} = 0.49 \text{ \AA}$  and  $\text{Cr}^{6+} = 0.44 \text{ \AA}$ .
- The *d* and *f* orbitals do not shield the nuclear charge very effectively. Thus there is a significant reduction in the size of ions just after 10*d* or 14*f* electrons have been filled in. The latter is called the lanthanide contraction, and results in the sizes of the second and third row transition elements being almost the same. This is discussed in Chapter 30.

### IONIZATION ENERGIES

If a small amount of energy is supplied to an atom, then an electron may be promoted to a higher energy level, but if the amount of energy supplied is sufficiently large the electron may be completely removed. The energy required to remove the most loosely bound electron from an isolated gaseous atom is called the ionization energy.

Ionization energies are determined from spectra and are measured in  $\text{kJ mol}^{-1}$ . It is possible to remove more than one electron from most atoms. The first ionization energy is the energy required to remove the first electron and convert  $M$  to  $M^+$ ; the second ionization energy is the energy required to remove the second electron and convert  $M^+$  to  $M^{2+}$ ; the third ionization energy converts  $M^{2+}$  to  $M^{3+}$ , and so on.

The factors that influence the ionization energy are:

- The size of the atom.
- The charge on the nucleus.
- How effectively the inner electron shells screen the nuclear charge.
- The type of electron involved (*s*, *p*, *d* or *f*).

These factors are usually interrelated. In a small atom the electrons are tightly held, whilst in a larger atom the electrons are less strongly held. Thus the ionization energy decreases as the size of the atoms increases.

Table 6.2 Ionization energies for Group I and II elements ( $\text{kJ mol}^{-1}$ )

	1st	2nd		1st	2nd	3rd
Li	520	7296	Be	899	1757	14847
Na	496	4563	Mg	737	1450	7731
K	419	3069	Ca	590	1145	4910
Rb	403	2650	Sr	549	1064	4207
Cs	376	2420	Ba	503	965	
Fr			Ra	509	979	3281*

\* Estimated value.

This trend is shown, for example, by Group I and Group II elements (See Table 6.2), and also by the other main groups.

Comparison of the first and second ionization energies for the Group I elements shows that removal of a second electron involves a great deal more energy, between 7 and 14 times more than the first ionization energy. Because the second ionization energy is so high, a second electron is not removed. The large difference between the first and second ionization energies is related to the structure of the Group I atoms. These atoms have just one electron in their outer shell. Whilst it is relatively easy to remove the single outer electron, it requires much more energy to remove a second electron, since this involves breaking into a filled shell of electrons.

The ionization energies for the Group II elements show that the first ionization energy is almost double the value for the corresponding Group I element. This is because the increased nuclear charge results in a smaller size for the Group II element. Once the first electron has been removed, the ratio of charges on the nucleus to the number of orbital electrons (the effective nuclear charge) is increased, and this reduces the size. For example,  $\text{Mg}^+$  is smaller than the Mg atom. Thus the remaining electrons in  $\text{Mg}^+$  are even more tightly held, and consequently the second ionization energy is greater than the first. Removal of a third electron from a Group II element is very much harder for two reasons:

1. The effective nuclear charge has increased, and hence the remaining electrons are more tightly held.
2. Removing another electron would involve breaking a completed shell of electrons.

The ionization energy also depends on the type of electron which is removed. *s*, *p*, *d* and *f* electrons have orbitals with different shapes. An *s* electron penetrates nearer to the nucleus, and is therefore more tightly held than a *p* electron. For similar reasons a *p* electron is more tightly held than a *d* electron, and a *d* electron is more tightly held than an *f* electron. Other factors being equal, the ionization energies are in the order  $s > p > d > f$ . Thus the increase in ionization energy is not quite smooth on moving from left to right in the periodic table. For example, the first ionization energy for a Group III element (where a *p* electron is being removed) is actually less than that for the adjacent Group II element (where an *s* electron is being removed).

In general, the ionization energy decreases on descending a group and increases on crossing a period. Removal of successive electrons becomes

Table 6.3 Comparison of some first ionization energies ( $\text{kJ mol}^{-1}$ )

Li 520	Be 899	B 801	C 1086	N 1403	O 1410	F 1681	Ne 2080
Na 496	Mg 737	Al 577	Si 786	P 1012	S 999	Cl 1255	Ar 1521



Table 6.4 First ionization energies of the elements

Group Period	I	II											III	IV	V	VI	VII	0	
1	H ● 1311																		He ● 2372
2	Li ● 520	Be ● 899											B ● 801	C ● 1086	N ● 1403	O ● 1410	F ● 1681	Ne ● 2080	
3	Na ● 496	Mg ● 737											Al ● 577	Si ● 786	P ● 1012	S ● 999	Cl ● 1255	Ar ● 1521	
4	K ● 419	Ca ● 590	Sc ● 631	Ti ● 656	V ● 650	Cr ● 652	Mn ● 717	Fe ● 762	Co ● 758	Ni ● 736	Cu ● 745	Zn ● 906	Ga ● 579	Ge ● 760	As ● 947	Se ● 941	Br ● 1142	Kr ● 1351	
5	Rb ● 403	Sr ● 549	Y ● 616	Zr ● 674	Nb ● 664	Mo ● 685	Tc ● 703	Ru ● 711	Rh ● 720	Pd ● 804	Ag ● 731	Cd ● 876	In ● 558	Sn ● 708	Sb ● 834	Te ● 869	I ● 1191	Xe ● 1170	
6	Cs ● 376	Ba ● 503	La ● 541	Hf ● 760	Ta ● 760	W ● 770	Re ● 759	Os ● 840	Ir ● 900	Pt ● 870	Au ● 889	Hg ● 1007	Tl ● 589	Pb ● 715	Bi ● 703	Po ● 813	At ● 912	Rn ● 1037	
7	Fr	Ra	Ac																

FIRST IONIZATION ENERGIES OF THE ELEMENTS

(Numerical values are given in  $\text{kJ mol}^{-1}$ .)

(Large circles indicate high values and small circles low values.)

After Sanderson, R.T., *Chemical Periodicity*, Reinhold, New York.

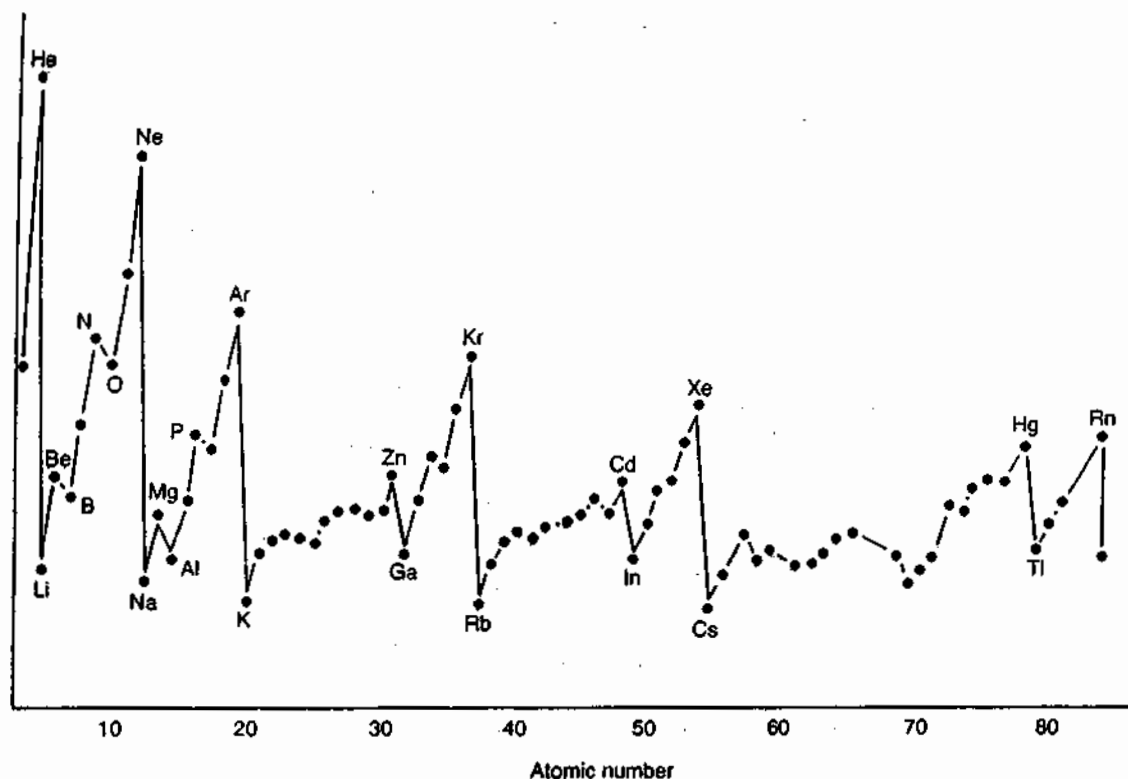

Figure 6.1 First ionization energies of the elements.

more difficult and first ionization energy  $<$  second ionization energy  $<$  third ionization energy. There are a number of deviations from these generalizations.

The variation in the first ionization energies of the elements are shown in Figure 6.1. The graph shows three features:

1. The noble gases He, Ne, Ar, Kr, Xe and Rn have the highest ionization energies in their respective periods.
2. The Group I metals Li, Na, K and Rb have the lowest ionization energies in their respective periods.
3. There is a general upward trend in ionization energy within a horizontal period, for example from Li to Ne or from Na to Ar.

The values for Ne and Ar are the highest in their periods because a great deal of energy is required to remove an electron from a stable filled shell of electrons.

The graph does not increase smoothly. The values for Be and Mg are high, and this is attributed to the stability of a filled  $s$  level. The values for N and P are also high, and this indicates that a half filled  $p$  level is also particularly stable. The values for B and Al are lower because removal of

one electron leaves a stable filled  $s$  shell, and similarly with O and S a stable half filled  $p$  shell is left.

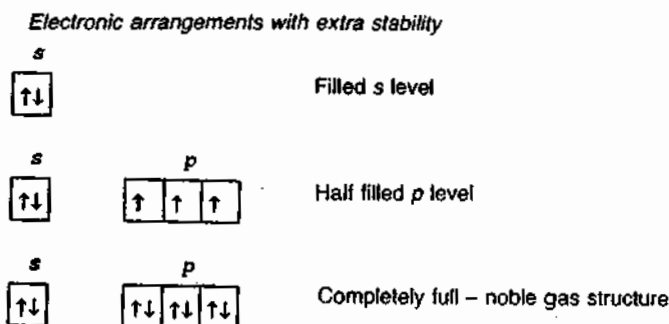

In general the first ionization energy decreases in a regular way on descending the main groups. A departure from this trend occurs in Group III, where the expected decrease occurs between B and Al, but the values for the remaining elements Ga, In and Tl do not continue the trend, and are irregular. The reason for the change at Ga is that it is preceded by ten elements of the first transition series (where the  $3d$  shell is being filled). This makes Ga smaller than it would otherwise be. A similar effect is observed with the second and third transition series, and the presence of the three transition series not only has a marked effect on the values for Ga, In and Tl, but the effect still shows in Groups IV and V.

**Table 6.5** Ionization energies for Group III elements ( $\text{kJ mol}^{-1}$ )

	1st	2nd	3rd
B	801	2427	3659
Al	577	1816	2744
Ga	579	1979	2962
In	558	1820	2704
Tl	589	1971	2877

The ionization energies of the transition elements are slightly irregular, but the third row elements starting at Hf have lower values than would be expected due to the interpolation of the 14 lanthanide elements between La and Hf.

## ELECTRON AFFINITY

The energy released when an extra electron is added to a neutral gaseous atom is termed the electron affinity. Usually only one electron is added, forming a uninegative ion. This repels further electrons and energy is needed to add on a second electron: hence the negative affinity of  $\text{O}^{2-}$ . Electron affinities depend on the size and effective nuclear charge. They

Table 6.6 Some electron affinity values ( $\text{kJ mol}^{-1}$ )

		H $\rightarrow$ H $^{-}$ - 72		
		He $\rightarrow$ He $^{-}$ 54		
Li $\rightarrow$ Li $^{-}$ -57	Na $\rightarrow$ Na $^{-}$ -21			
Be $\rightarrow$ Be $^{-}$ 66	Mg $\rightarrow$ Mg $^{-}$ 67			
B $\rightarrow$ B $^{-}$ -15	Al $\rightarrow$ Al $^{-}$ -26			
C $\rightarrow$ C $^{-}$ -121	Si $\rightarrow$ Si $^{-}$ -135			
N $\rightarrow$ N $^{-}$ 31	P $\rightarrow$ P $^{-}$ -60			
O $\rightarrow$ O $^{-}$ -142	S $\rightarrow$ S $^{-}$ -200			
O $\rightarrow$ O $^{2-}$ 702	S $\rightarrow$ S $^{2-}$ 332			
F $\rightarrow$ F $^{-}$ -333	Cl $\rightarrow$ Cl $^{-}$ -348	Br $\rightarrow$ Br $^{-}$ -324	I $\rightarrow$ I $^{-}$ -295	
Ne $\rightarrow$ Ne $^{-}$ 99				

cannot be determined directly, but are obtained indirectly from the Born-Haber cycle.

Negative electron affinity values indicate that energy is given out when the atom accepts an electron. The above values show that the halogens all evolve a large amount of energy on forming negative halide ions, and it is not surprising that these ions occur in a large number of compounds.

Energy is evolved when one electron is added to an O or S atom, forming the species O $^{-}$  and S $^{-}$ , but a substantial amount of energy is absorbed when two electrons are added to form O $^{2-}$  and S $^{2-}$  ions. Even though it requires energy to form these divalent ions, compounds containing these ions are known. It follows that the energy required to form the ions must come from some other process, such as the lattice energy when the ions are packed together in a regular way to form a crystalline solid, or from solvation energy in solution. It is always dangerous to consider one energy term in isolation, and a complete energy cycle should be considered whenever possible.

### BORN-HABER CYCLE

This cycle devised by Born and Haber in 1919 relates the lattice energy of a crystal to other thermochemical data. The energy terms involved in building a crystal lattice such as sodium chloride may be taken in steps. The elements in their standard state are first converted to gaseous atoms, and then to ions, and finally packed into the crystal lattice.

The enthalpies of sublimation and dissociation and the ionization energy are positive since energy is supplied to the system. The electron affinity and lattice energy are negative since energy is evolved in these processes.

According to Hess's law, the overall energy change in a process depends only on the energy of the initial and final states and not on the route taken. Thus the enthalpy of formation  $\Delta H_f$  is equal to the sum of the terms going the other way round the cycle.

$$-\Delta H_f = \Delta H_s + I + \frac{1}{2}\Delta H_d - E - U$$

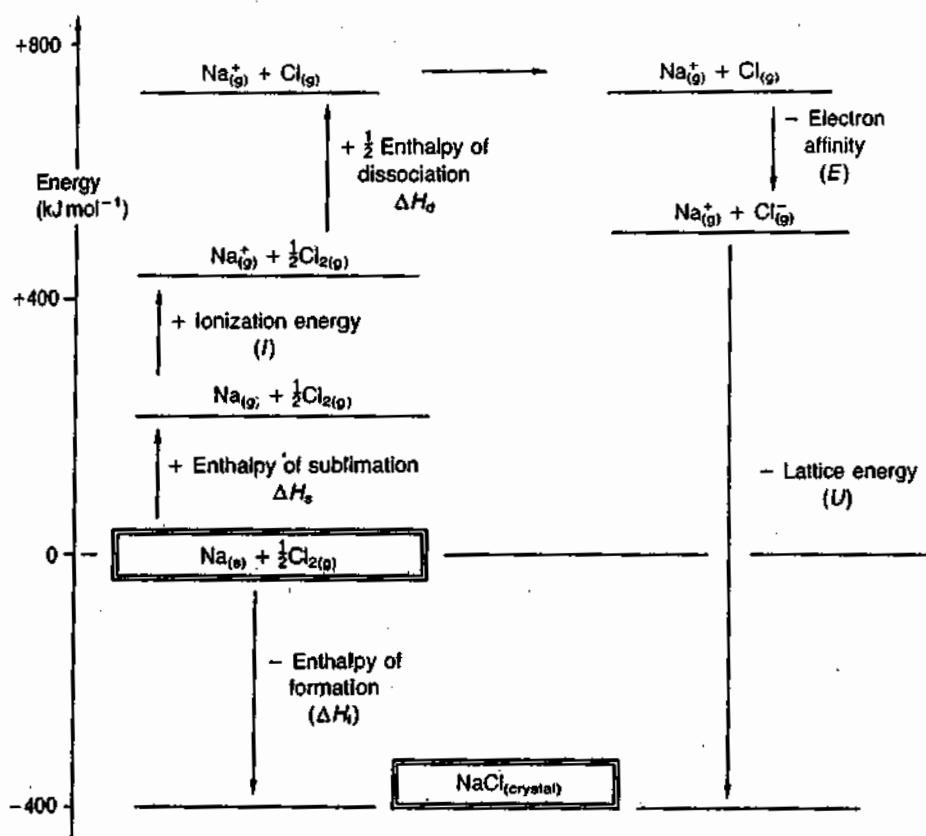

Figure 6.2 Born-Haber cycle for the formation of NaCl.

All the terms except the lattice energy and electron affinity can be measured. Originally the cycle was used to calculate electron affinities. By using known crystal structures, it was possible to calculate the lattice energy, and hence values were obtained for the electron affinity.

$$-\Delta H_f = +\Delta H_s + I + \frac{1}{2}H_o - E - U$$

For NaCl  $-381.2 = +108.4 + 495.4 + 120.9 - E - 757.3$   
hence  $E = -348.6 \text{ kJ mol}^{-1}$

Now that some electron affinity values are known, the cycle is used to calculate the lattice energy for unknown crystal structures.

It is useful to know the lattice energy, as a guide to the solubility of the crystal. When a solid dissolves, the crystal lattice must be broken up (which requires that energy is put in). The ions so formed are solvated (with the evolution of energy). When the lattice energy is high a large amount of energy is required to break the lattice. It is unlikely that the enthalpy of solvation will be big enough (and evolve sufficient energy to offset this), so the substance will probably be insoluble.

Table 6.7 Comparison of theoretical and experimental lattice energies

	Theoretical lattice energy (kJ mol <sup>-1</sup> )	Born-Haber lattice energy (kJ mol <sup>-1</sup> )	% difference
LiCl	-825	-817	0.8
NaCl	-764	-764	0.0
KCl	-686	-679	1.0
KI	-617	-606	1.8
CaF <sub>2</sub>	-2584	-2611	1.0
CdI <sub>2</sub>	-1966	-2410	22.6

The 'noble behaviour' of many transition metals, that is their resistance to chemical attack, is related to a similar series of energy changes. Noble character is favoured by a high heat of sublimation, high ionization energy and low enthalpy of solvation of the ions.

Lattice energies may also provide some information about the ionic/covalent nature of the bonding. If the lattice energy is calculated theoretically assuming ionic bonding then the value can be compared with the experimental value for the lattice energy obtained from the experimentally measured quantities in the Born-Haber cycle. Close agreement indicates that the assumption that bonding is ionic is in fact true, whilst poor agreement may indicate that the bonding is not ionic. A number of lattice energies are compared in Table 6.7. The agreement is good for all the compounds listed except for CdI<sub>2</sub>, confirming that these are ionic. The large discrepancy for CdI<sub>2</sub> indicates that the structure is not ionic, and in fact it forms a layer structure which is appreciably covalent.

#### POLARIZING POWER AND POLARIZABILITY – FAJANS' RULES

Consider making a bond theoretically by bringing two ions A<sup>+</sup> and B<sup>-</sup> together to their equilibrium distance. Will the bond remain ionic, or will it become covalent? Ionic and covalent bonding are two extreme types of bonding, and almost always the bonds formed are intermediate in type, and this is explained in terms of polarizing (that is deforming) the shape of the ions.

The type of bond between A<sup>+</sup> and B<sup>-</sup> depends on the effect one ion has on the other. The positive ion attracts the electrons on the negative ion and at the same time it repels the nucleus, thus distorting or polarizing the negative ion. The negative ion will also polarize the positive ion, but since anions are usually large, and cations small, the effect of a large ion on a small one will be much less pronounced. If the degree of polarization is quite small, then the bond remains largely ionic. If the degree of polarization is large, electrons are drawn from the negative ion towards the positive ion, resulting in a high concentration of electrons between the two nuclei, and a large degree of covalent character results.

The extent to which ion distortion occurs depends on the power of an ion to distort the other ion (that is on its polarizing power) and also on how susceptible the ion is to distortion (that is on its polarizability). Generally the polarizing power increases as ions become smaller and more highly charged. The polarizability of a negative ion is greater than that of a positive ion since the electrons are less firmly bound because of the differences in effective nuclear charge. Large negative ions are more polarizable than small ones.

Fajans put forward four rules which summarize the factors favouring polarization and hence covalency.

1. *A small positive ion favours covalency.*

In small ions the positive charge is concentrated over a small area. This makes the ion highly polarizing, and very good at distorting the negative ion.

2. *A large negative ion favours covalency.*

Large ions are highly polarizable, that is easily distorted by the positive ion, because the outermost electrons are shielded from the charge on the nucleus by filled shells of electrons.

3. *Large charges on either ion, or on both ions, favour covalency.*

This is because a high charge increases the amount of polarization.

4. *Polarization, and hence covalency, is favoured if the positive ion does not have a noble gas configuration.*

Examples of ions which do not have a noble gas configuration include a few main group elements such as  $Tl^+$ ,  $Pb^{2+}$  and  $Bi^{3+}$ , many transition metal ions such as  $Ti^{3+}$ ,  $V^{3+}$ ,  $Cr^{2+}$ ,  $Mn^{2+}$  and  $Cu^+$ , and some lanthanide metal ions such as  $Ce^{3+}$  and  $Eu^{2+}$ . A noble gas configuration is the most effective at shielding the nuclear charge, so ions without the noble gas configuration will have high charges at their surfaces, and thus be highly polarizing.

## ELECTRONEGATIVITY

In 1931, Pauling defined the electronegativity of an atom as the tendency of the atom to attract electrons to itself *when combined in a compound*.

The implication of this is that when a covalent bond is formed, the electrons used for bonding need not be shared equally by both atoms. If the bonding electrons spend more time round one atom, that atom will have a  $\delta^-$  charge, and consequently the other atom will have a  $\delta^+$  charge. In the extreme case where the bonding electrons are round one atom all of the time, the bond is ionic. Pauling and others have attempted to relate the electronegativity difference between two atoms to the amount of ionic character in the bond between them.

Generally, small atoms attract electrons more strongly than large ones, and hence small atoms are more electronegative. Atoms with nearly filled shells of electrons tend to have higher electronegativities than those with sparsely occupied ones. Electronegativity values are very difficult to

measure. Even worse, a particular type of atom in different molecules may well be in a different environment. It is unlikely that the electronegativity of an atom remains constant regardless of its environment, though it is invariably assumed that it is constant. Some of the more important approaches to obtaining electronegativity values are outlined below.

### Pauling

Pauling pointed out that since reactions of the type:

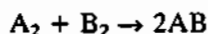

are almost always exothermic, the bond formed between the two atoms A and B must be stronger than the average of the single bond energies of A—A and B—B molecules. For example:

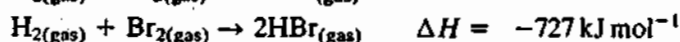
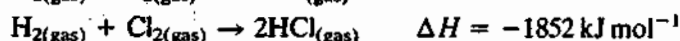
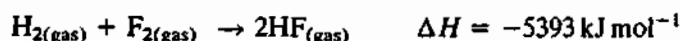

The bonding molecular orbital for AB ( $\phi_{AB}$ ) is made up from contributions from the wave functions for the appropriate atomic orbitals ( $\psi_A$  and  $\psi_B$ ).

$$\phi_{AB} = (\psi_A) + \text{constant} (\psi_B)$$

If the constant is greater than 1, the molecular orbital is concentrated on the B atom, which therefore acquires a partial negative charge, and the bond is partly polar.

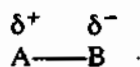

Conversely, if the constant is less than 1, atom A gains a partial negative charge. Because of this partial ionic character, the A—B bond is stronger than would be expected for a pure covalent bond. The extra bond energy is called delta  $\Delta$ .

$$\Delta = (\text{actual bond energy}) - (\text{energy for 100\% covalent bond})$$

The bond energy can be measured, but the energy of a 100% covalent bond must be calculated. Pauling suggested the 100% covalent bond energy be calculated as the geometric mean of the covalent energies of A—A and B—B molecules.

$$E_{100\% \text{ covalent } A-B} = \sqrt{(E_{A-A} \cdot E_{B-B})}$$

The bond energy in A—A and B—B molecules can be measured and so:

$$\Delta = (\text{actual bond energy}) - \sqrt{(E_{A-A} \cdot E_{B-B})}$$

Pauling states that the electronegativity difference between two atoms is equal to  $0.208/\Delta$ , where  $\Delta$  is the extra bond energy in  $\text{kcal mol}^{-1}$ .



(Converting the equation to SI units gives  $0.1017/\Delta$ , where  $\Delta$  is measured in  $\text{kJ mol}^{-1}$ .)

Pauling evaluated  $0.208/\Delta$  for a number of bonds and called this the electronegativity difference between A and B. Repeating Pauling's calculation with SI units for energy, we can evaluate  $0.1017/\Delta$ :

Bond	$\Delta(\text{kJ mol}^{-1})$	$0.1017/\Delta$	
C—H	24.3	0.50	i.e. $\chi_{\text{C}} - \chi_{\text{H}} = 0.50$
H—Cl	102.3	1.02	i.e. $\chi_{\text{Cl}} - \chi_{\text{H}} = 1.02$
N—H	105.9	1.04	i.e. $\chi_{\text{N}} - \chi_{\text{H}} = 1.04$

( $\chi$  (chi) = electronegativity of atom)

If  $\chi_{\text{H}} = 0$  then the electronegativity values for C, Cl and N would be 0.50, 1.02 and 1.04 respectively. Pauling changed the origin of the scale from  $\chi_{\text{H}} = 0$  to  $\chi_{\text{H}} = 2.05$  to avoid having any negative values in the table of values, and this made the value for C become 2.5 and the value for F become 4.0. At the same time the values for a number of other elements approximated to whole numbers: Li = 1.0, B = 2.0, N = 3.0. Thus by adding 2.05 to the values calculated in this way we can obtain the usually accepted electronegativity values (Table 6.8).

If two atoms have similar electronegativities, that is a similar tendency to attract electrons, the bond between them will be predominantly covalent. Conversely a large difference in electronegativity leads to a bond with a high degree of polar character, that is a bond that is predominantly ionic.

Rather than have two extreme forms of bond (ionic and covalent), Pauling introduced the idea that the ionic character of a bond varies with

**Table 6.8** Pauling's electronegativity coefficients (for the most common oxidation states of the elements)

						H
						2.1
Li	Be	B	C	N	O	F
1.0	1.5	2.0	2.5	3.0	3.5	4.0
Na						Cl
0.9						3.0
K						Br
0.8						2.8
Rb						I
0.8						2.5
Cs						
0.7						

**Table 6.9 Pauling's electronegativity values**

Group \ Period	I	II											III	IV	V	VI	VII	0
1	H ● 2.1																H ● 2.1	He
2	Li ● 1.0	Be ● 1.5											B ● 2.0	C ● 2.5	N ● 3.0	O ● 3.5	F ● 4.0	Ne
3	Na ● 0.9	Mg ● 1.2											Al ● 1.5	Si ● 1.8	P ● 2.1	S ● 2.5	Cl ● 3.0	Ar
4	K ● 0.8	Ca ● 1.0	Sc ● 1.3	Ti ● 1.5	V ● 1.6	Cr ● 1.6	Mn ● 1.5	Fe ● 1.8	Co ● 1.8	Ni ● 1.8	Cu ● 1.9	Zn ● 1.6	Ga ● 1.6	Ge ● 1.8	As ● 2.0	Se ● 2.4	Br ● 2.8	Kr
5	Rb ● 0.8	Sr ● 1.0	Y ● 1.2	Zr ● 1.4	Nb ● 1.6	Mo ● 1.8	Tc ● 1.9	Ru ● 2.2	Rh ● 2.2	Pd ● 2.2	Ag ● 1.9	Cd ● 1.7	In ● 1.7	Sn ● 1.8	Sb ● 1.9	Te ● 2.1	I ● 2.5	Xe
6	Cs ● 0.7	Ba ● 0.9	La ● 1.1	Hf ● 1.3	Ta ● 1.5	W ● 1.7	Re ● 1.9	Os ● 2.2	Ir ● 2.2	Pt ● 2.2	Au ● 2.4	Hg ● 1.9	Tl ● 1.8	Pb ● 1.8	Bi ● 1.9	Po ● 2.0	At ● 2.2	Rn
7	Fr ● 0.7	Ra ● 0.9	Ac ● 1.1															

**PAULING'S ELECTRONEGATIVITY VALUES**

Electronegativity varies with the oxidation state of the element. The values given are for the most common oxidation states. (Large circles indicate high values and small circles small values.)

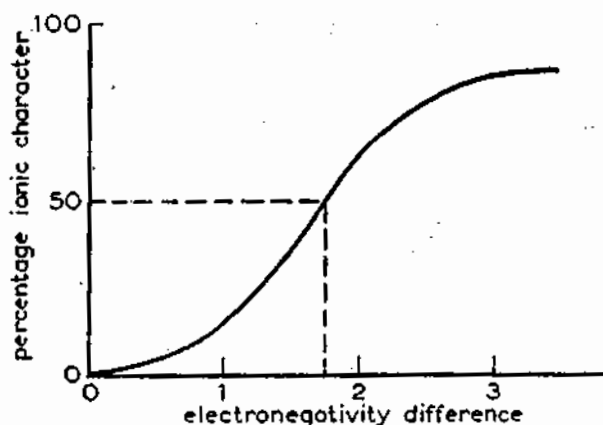

Figure 6.3 Electronegativity difference.

the difference in electronegativity as shown in Figure 6.3. This graph is based on the ionic characters HI 4% ionic, HBr 11%, HCl 19% and HF 45%, which are known from dipole measurements. Fifty per cent ionic character occurs when the electronegativity difference between the atoms is about 1.7, so for a larger difference than this a bond is more ionic than covalent. Similarly, if the electronegativity difference is less than 1.7, the bond is more covalent than ionic. It is better to describe a bond such as one of those in  $\text{BF}_3$  as 63% ionic, rather than just ionic.

#### Mulliken

In 1934, Mulliken suggested an alternative approach to electronegativity based on the ionization energy and electron affinity of an atom. Consider two atoms A and B. If an electron is transferred from A to B, forming ions  $\text{A}^+$  and  $\text{B}^-$ , then the energy change is the ionization energy of atom A ( $I_A$ ) minus the electron affinity of atom B ( $E_B$ ), that is  $I_A - E_B$ . Alternatively, if the electron was transferred the other way to give  $\text{B}^+$  and  $\text{A}^-$  ions, then the energy change would be  $I_B - E_A$ . If  $\text{A}^+$  and  $\text{B}^-$  are actually formed, then this process requires less energy, and

$$(I_A - E_B) < (I_B - E_A)$$

Rearranging

$$(I_A + E_A) < (I_B + E_B)$$

Thus Mulliken suggested that electronegativity could be regarded as the average of the ionization energy and the electron affinity of an atom.

$$\text{Electronegativity} = \frac{(I + E)}{2}$$

Mulliken used  $I$  and  $E$  values measured in electron volts, and the values were about 2.8 times larger than the Pauling values. We now measure  $I$  and

$E$  in  $\text{kJ mol}^{-1}$ . The energy  $1\text{ eV/molecule} = 96.48\text{ kJ mol}^{-1}$ , so the commonly accepted Pauling values are more nearly obtained by performing this calculation  $(I + E)/(2 \times 2.8 \times 96.48)$  or  $(I + E)/540$ .

This method has a simple theoretical basis, and also has the advantage that different values can be obtained for different oxidation states of the same element. It suffers from the limitation that only a few electron affinities are known. It is more usual to use the approach based on bond energies.

#### Allred and Rochow

In 1958 Allred and Rochow considered electronegativity in a different way, and worked out values for 69 elements. (See Further Reading.) They defined electronegativity as the attractive force between a nucleus and an electron at a distance equal to the covalent radius. This force  $F$  is electrostatic, and is given by:

$$F = \frac{e^2 \cdot Z_{\text{effective}}}{r^2}$$

where  $e$  is the charge on an electron,  $r$  is the covalent radius, and  $Z_{\text{effective}}$  is the effective nuclear charge. The latter is the nuclear charge modified by screening factors for the orbital electrons. The screening factors vary depending on the principal quantum number (the shell that the electron occupies), and the type of electron,  $s$ ,  $p$ ,  $d$  or  $f$ . Screening factors have been worked out by Slater, so this provides a convenient method of calculating electronegativity values. These  $F$  values may be converted to electronegativity values on the Pauling scale of values using an empirical relationship:

$$\chi = 0.744 + \frac{0.359 Z_{\text{effective}}}{r^2}$$

The electronegativity values so obtained agree quite closely with those obtained by Pauling and Mulliken.

As the oxidation number of an atom increases, the attraction for the electrons increases, so the electronegativity should also increase. Allred and Rochow's method gives slightly different values:

Mo(II)	2.18	Fe(II)	1.83	Tl(I)	1.62	Sn(II)	1.80
Mo(III)	2.19	Fe(III)	1.96	Tl(III)	2.04	Sn(IV)	1.96
Mo(IV)	2.24						
Mo(V)	2.27						
Mo(VI)	2.35						

Allred and Rochow's method depends on measuring covalent radii (and these are obtained with great accuracy by X-ray crystallography) so it might be expected to yield very accurate electronegativity values. This is not so, because although the interatomic distances can be measured very

precisely, covalent radii are much less well known because the multiplicity of the bond is not known for certain, that is the bond may possess some double bond character.

The electronegativity values given in this book are those due to Pauling, but others have been calculated from different theoretical assumptions by Mulliken, Allred and Rochow and Sanderson. For details of these and several modern reviews of electronegativity values see Further Reading. *It is now considered that attempts to measure very accurate values for electronegativity are unjustified, and it is better to retain a loose definition of electronegativity, and use it for a more qualitative description of bonds.* For this purpose, it is worth remembering a few electronegativity values (see Table 6.8). From these it is possible to make a reasonable guess at the values for other elements, and hence predict the nature of the bonds formed. Bonds between atoms with similar electronegativity values will be largely non-polar (covalent), and bonds between atoms with a large electronegativity difference will be largely polar (ionic). Predictions using electronegativity in general agree with those made using Fajans' rules.

The basic properties of elements are inversely related to the electronegativity. Thus on descending one of the main groups, the electronegativity decreases, and basic properties increase. Similarly, on going across a period the elements become more electronegative, and less basic.

## METALLIC CHARACTER

Metals are electropositive and have a tendency to lose electrons, if supplied with energy:



The stronger this tendency, the more electropositive and more metallic an element is. The tendency to lose electrons depends on the ionization energy. It is easier to remove an electron from a large atom than from a small one, so metallic character increases as we descend the groups in the periodic table. Thus in Group IV, carbon is a non-metal, germanium shows some metallic properties, and tin and lead are metals. Similarly, metallic character decreases from left to right across the periodic table because the size of the atoms decreases and the ionization energy increases. Thus sodium and magnesium are more metallic than silicon, which, in turn, is more metallic than chlorine. The most electropositive elements are found in the lower left of the periodic table and the most non-metallic in the top right.

Electropositivity is really the converse of electronegativity, but it is convenient to use the concept of electropositivity when describing metals. Strongly electropositive elements give ionic compounds. Metallic oxides and hydroxides are basic since they ionize, and give hydroxyl ions:

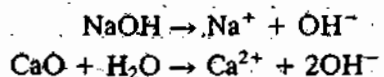

Oxides which are insoluble in water cannot produce  $\text{OH}^-$  in this way, and these are regarded as basic if they react with acids to form salts. Thus in the main groups of the periodic table, basic properties increase on descending a group because the elements become more electropositive and more ionic. However, this generalization does not hold for the *d*-block, and particularly for the central groups of transition elements (Cr, Mn, Fe, Co, Ni) where basicity and the ability to form simple ions decreases on descending the group.

The degree of electropositivity is shown in a variety of ways. Strongly electropositive elements react with water and acids. They form strongly basic oxides and hydroxides, and they react with oxoacids to give stable salts such as carbonates, nitrates and sulphates. Weakly electropositive elements are unaffected by water and are much less readily attacked by acids. Their oxides are frequently amphoteric, and react with both acids and alkalis. They are not basic enough to form stable carbonates.

The electropositive nature of a metal is also shown in the degree of hydration of the ions. In the change  $\text{M}^+$  to  $[(\text{H}_2\text{O})_n \rightarrow \text{M}]^+$  the positive charge becomes spread over the whole complex ion. Since the charge is no longer localized on the metal, this is almost the same as the change  $\text{M}^+ \rightarrow \text{M}$ . Strongly electropositive metals have a great tendency to the opposite change,  $\text{M} \rightarrow \text{M}^+$ , so that they are not readily hydrated. The less electropositive the metal, the weaker the tendency  $\text{M} \rightarrow \text{M}^+$  and the stronger the degree of hydration. Thus the elements in Group II are less electropositive than those of Group I, and Group II ions are more heavily hydrated than those in Group I. The degree of hydration also decreases down a group, e.g.  $\text{MgCl}_2 \cdot 6\text{H}_2\text{O}$  and  $\text{BaCl}_2 \cdot 2\text{H}_2\text{O}$ .

Salts of strongly electropositive metals have little tendency to hydrolyse and form oxosalts. Since the metal ion is large, it has little tendency to form complexes. On the other hand, salts of weakly electropositive elements hydrolyse and may form oxosalts. Because they are smaller, the metal ions have a greater tendency to form complexes.

### VARIABLE VALENCY AND OXIDATION STATES

In the *s*-block the oxidation state is always the same as the group number. For *p*-block elements, the oxidation state is normally the group number or eight minus the group number. Variable valency does occur to a limited extent in the *p*-block. In these cases the oxidation state always changes by two, e.g.  $\text{TiCl}_3$  and  $\text{TiCl}$ ,  $\text{SnCl}_4$  and  $\text{SnCl}_2$ ,  $\text{PCl}_5$  and  $\text{PCl}_3$ , and is due to a pair of electrons remaining paired and not taking part in bonding (the inert pair effect). The term oxidation state is preferred to valency. The oxidation state may be defined as the charge left on the central atom when all the other atoms of the compound have been removed in their usual oxidation states. Thus Ti shows oxidation states of (+III) and (+I), Sn of (+IV) and (+II), and P of (+V) and (+III). The oxidation number can be calculated equally well for ionic or covalent compounds, and without knowing the types of bonds. The oxidation number of S in  $\text{H}_2\text{SO}_4$  can be worked out as

follows. O usually has an oxidation state of (-II) (except in  $O_2$  and  $O_2^{2-}$ ). H usually has an oxidation state of (+I) (except in  $H_2$  and  $H^-$ ). The sum of the oxidation numbers of all the atoms in  $H_2SO_4$  is zero, so:

$$(2 \times 1) + (S^x) + (4 \times -2) = 0$$

Thus  $x$ , the oxidation state of S, is (+VI). In the case of the oxidation state of Mn in  $KMnO_4$ , the compound ionizes into  $K^+$  and  $MnO_4^-$  ions. In  $MnO_4^-$  the sum of the oxidation states is equal to the charge on the ion, so:

$$Mn^x + (4 \times -2) = -1$$

Thus  $x$ , the oxidation state of Mn, is 7, i.e. (+VII).

One of the most striking features of the transition elements is that the elements usually exist in several different oxidation states. Furthermore, the oxidation states change in units of 1, e.g.  $Fe^{3+}$  and  $Fe^{2+}$ ,  $Cu^{2+}$  and  $Cu^+$ . This is in contrast to the *s*-block and *p*-block elements. The reason why this occurs is that a different number of *d* electrons may take part in bonding.

Though the oxidation number is the same as the charge on the ion for ions such as  $Tl^+$  and  $Tl^{3+}$ , the two are not necessarily the same. Thus Mn exists in the oxidation state (+VII) but  $Mn^{7+}$  does not exist, as  $KMnO_4$  ionizes into  $K^+$  and  $MnO_4^-$ .

## STANDARD ELECTRODE POTENTIALS AND ELECTROCHEMICAL SERIES

When a metal is immersed in water, or a solution containing its own ions, the metal tends to lose positive metal ions into the solution. Thus the metal acquires a negative charge.

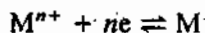

The size of the electric potential  $E$  set up between the two depends on the particular metal, the number of electrons involved, the activity of the ions in solution, and the temperature.  $E^\circ$  is the standard electrode potential, which is a constant for any particular metal and is in fact the electrode potential measured under standard conditions of temperature and with unit activity. These terms are related by the equation:

$$E = E^\circ + \frac{RT}{nF} \ln(a)$$

(where  $R$  is the gas constant,  $T$  the absolute temperature,  $a$  the activity of the ions in solution,  $n$  the valency of the ion and  $F$  the Faraday). For most purposes, the activity,  $a$ , may be replaced by the concentration of ions in solution.

The potential of a single electrode cannot be measured, but if a second electrode of known potential is placed in the solution, the potential difference between the two electrodes can be measured. The standard against which all electrode potentials are compared is the hydrogen electrode.

**Table 6.10** Standard electrode potentials (volts at 25°C)

Li <sup>+</sup>	Li	-3.05
K <sup>+</sup>	K	-2.93
Ca <sup>2+</sup>	Ca	-2.84
Al <sup>3+</sup>	Al	-1.66
Mn <sup>2+</sup>	Mn	-1.08
Zn <sup>2+</sup>	Zn	-0.76
Fe <sup>2+</sup>	Fe	-0.44
Cd <sup>2+</sup>	Cd	-0.40
Co <sup>2+</sup>	Co	-0.27
Ni <sup>2+</sup>	Ni	-0.23
Sn <sup>2+</sup>	Sn	-0.14
Pb <sup>2+</sup>	Pb	-0.13
H <sup>+</sup>	H <sub>2</sub>	0.00
Cu <sup>2+</sup>	Cu	+0.35
Ag <sup>+</sup>	Ag	+0.80
Au <sup>3+</sup>	Au	+1.38

**Table 6.11** Standard electrode potentials (V)

O <sub>2</sub>   OH <sup>-</sup>	+0.40
I <sub>2</sub>   I <sup>-</sup>	+0.57
Br <sub>2</sub>   Br <sup>-</sup>	+1.07
Cl <sub>2</sub>   Cl <sup>-</sup>	+1.36
F <sub>2</sub>   F <sup>-</sup>	+2.85

(This comprises a platinized platinum electrode, which is saturated with hydrogen at one atmosphere pressure and immersed in a solution of H<sub>3</sub>O<sup>+</sup> at unit activity. The potential developed by this electrode is arbitrarily fixed as zero.)

If the elements are arranged in order of increasing standard electrode potentials, the resulting Table 6.10 is called the electrochemical series.

Electrode potentials can also be measured for elements such as oxygen and the halogens which form negative ions (Table 6.11).

In the electrochemical series the most electropositive elements are at the top and the least electropositive at the bottom. The greater the negative value of the potential, the greater is the tendency for a metal to ionize. Thus a metal high in the electrochemical series will displace another metal lower down the series from solution. For example, iron is above copper in the electrochemical series, and scrap iron is sacrificed to displace Cu<sup>2+</sup> ions from solution of CuSO<sub>4</sub> in the recovery of metallic copper.



In the Daniell cell zinc displaces copper from copper salts in solution. This causes the potential difference between the plates.

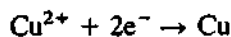

Table 6.12 Some standard reduction potentials in acid solution at 25°C (volts)

Group I	$E^\circ$	Group V	$E^\circ$	Group VIII	$E^\circ$
$\text{Li}^+ + e \rightarrow \text{Li}$	-3.05	$\text{As} + 3e \rightarrow \text{AsH}_3$	-0.60	$\text{I}_3^- + 2e \rightarrow 3\text{I}^-$	+0.54
$\text{K}^+ + e \rightarrow \text{K}$	-2.93	$\text{Sb} + 3e \rightarrow \text{SbH}_3$	-0.51	$\text{Br}_3^- + 2e \rightarrow 3\text{Br}^-$	+1.05
$\text{Rb}^+ + e \rightarrow \text{Rb}$	-2.93	$\text{H}_3\text{PO}_2 + e \rightarrow \text{P}$	-0.51	$2\text{ICl}_2^- + 2e \rightarrow \text{I}_2$	+1.06
$\text{Cs}^+ + e \rightarrow \text{Cs}$	-2.92	$\text{H}_3\text{PO}_3 + 2e \rightarrow \text{H}_3\text{PO}_2$	-0.50	$\text{Br}_2 + 2e \rightarrow 2\text{Br}^-$	+1.07
$\text{Na}^+ + e \rightarrow \text{Na}$	-2.71	$\text{H}_3\text{PO}_4 + 2e \rightarrow \text{H}_3\text{PO}_3$	-0.28	$2\text{IO}_3^- + 10e \rightarrow \text{I}_2$	+1.20
		$\frac{1}{2}\text{N}_2 + 3e \rightarrow \text{NH}_4^+$	-0.27	$\text{Cl}_2 + 2e \rightarrow 2\text{Cl}^-$	+1.36
<i>Group II</i>		$\frac{1}{2}\text{N}_2 + 2e \rightarrow \frac{1}{2}\text{N}_2\text{H}_5^+$	-0.23	$2\text{HOI} + 2e \rightarrow \text{I}_2$	+1.45
$\text{Ba}^{2+} + 2e \rightarrow \text{Ba}$	-2.90	$\text{P} + 3e \rightarrow \text{PH}_3$	+0.06	$\text{H}_5\text{IO}_6 + 2e \rightarrow \text{IO}_3^-$	+1.60
$\text{Sr}^{2+} + 2e \rightarrow \text{Sr}$	-2.89	$\frac{1}{2}\text{Sb}_2\text{O}_3 + 3e \rightarrow \text{Sb}$	+0.15	$2\text{HOCl} + 2e \rightarrow \text{Cl}_2$	+1.63
$\text{Ca}^{2+} + 2e \rightarrow \text{Ca}$	-2.87	$\text{HAsO}_2 + 3e \rightarrow \text{As}$	+0.25	$\text{F}_2 + 2e \rightarrow 2\text{F}^-$	+2.65
$\text{Mg}^{2+} + 2e \rightarrow \text{Mg}$	-2.37	$\text{H}_3\text{AsO}_4 + 2e \rightarrow \text{HAsO}_2$	+0.56		
$\text{Be}^{2+} + 2e \rightarrow \text{Be}$	-1.85	$\text{HN}_3 + 8e \rightarrow 3\text{NH}_4^+$	+0.69	<i>Transition Metals</i>	
		$\text{NO}_3^- + 3e \rightarrow \text{NO}$	+0.96	$\text{La}^{3+} + 3e \rightarrow \text{La}$	-2.52
		$\text{HNO}_2 + e \rightarrow \text{NO}$	+1.00	$\text{Sc}^{3+} + 3e \rightarrow \text{Sc}$	-2.08
<i>Group III</i>		$\frac{1}{2}\text{N}_2\text{O}_4 + 2e \rightarrow \text{NO}$	+1.03	$\text{Mn}^{2+} + 2e \rightarrow \text{Mn}$	-1.18
$\text{Al}^{3+} + 3e \rightarrow \text{Al}$	-1.66	$\frac{1}{2}\text{N}_2\text{H}_4^+ + 2e \rightarrow \text{NH}_3^+$	+1.28	$\text{Zn}^{2+} + 2e \rightarrow \text{Zn}$	-0.76
$\text{Ga}^{3+} + 3e \rightarrow \text{Ga}$	-0.53	$\text{NH}_3\text{OH} + 2e \rightarrow \text{NH}_4^+$	+1.35	$\text{Cr}^{3+} + 3e \rightarrow \text{Cr}$	-0.74
$\text{In}^{3+} + 3e \rightarrow \text{In}$	-0.34			$\text{Fe}^{2+} + 2e \rightarrow \text{Fe}$	-0.44
$\text{Tl}^+ + e \rightarrow \text{Tl}$	-0.34	<i>Group VI</i>		$\text{Cr}^{3+} + e \rightarrow \text{Cr}^{2+}$	-0.41
$\text{Tl}^{3+} + 2e \rightarrow \text{Tl}^+$	+1.25	$\text{Te} + 2e \rightarrow \text{H}_2\text{Te}$	-0.72	$\text{Cd}^{2+} + 2e \rightarrow \text{Cd}$	-0.40
		$\text{Se} + 2e \rightarrow \text{H}_2\text{Se}$	-0.40	$\text{Ni}^{2+} + 2e \rightarrow \text{Ni}$	-0.25
<i>Group IV</i>		$\text{S}_4\text{O}_6^{2-} + 2e \rightarrow 2\text{S}_2\text{O}_3^{2-}$	+0.08	$\text{Cu}^{2+} + e \rightarrow \text{Cu}^+$	+0.15
$\text{SiO}_2 + 4e \rightarrow \text{Si}$	-0.86	$\text{S} + 2e \rightarrow \text{H}_2\text{S}$	+0.14	$\text{Hg}_2\text{Cl}_2 + 2e \rightarrow 2\text{Hg}$	+0.27
$\text{PbSO}_4 + 2e \rightarrow \text{Pb}$	-0.36	$\text{HSO}_4^- + 2e \rightarrow \text{H}_2\text{SO}_3$	+0.17	$\text{Cu}^{2+} + 2e \rightarrow \text{Cu}$	+0.35
$\text{CO}_2 + 4e \rightarrow \text{C}$	-0.20	$\text{H}_2\text{SO}_3 + 2e \rightarrow \frac{1}{2}\text{S}_2\text{O}_3^{2-}$	+0.40	$[\text{Fe}(\text{CN})_6]^{3-} + e \rightarrow [\text{Fe}(\text{CN})_6]^{4-}$	+0.36
$\text{GeO}_2 + 4e \rightarrow \text{Ge}$	-0.15	$\text{H}_2\text{SO}_3 + 4e \rightarrow \text{S}$	+0.45	$\text{Cu}^+ + e \rightarrow \text{Cu}$	+0.50
$\text{Sn}^{2+} + 2e \rightarrow \text{Sn}$	-0.14	$4\text{H}_2\text{SO}_3 + 6e \rightarrow \text{S}_4\text{O}_6^{2-}$	+0.51	$\text{Cu}^{2+} + e \rightarrow \text{CuCl}$	+0.54
$\text{Pb}^{2+} + 2e \rightarrow \text{Pb}$	-0.13	$\text{S}_2\text{O}_6^{2-} + 2e \rightarrow 2\text{H}_2\text{SO}_4$	+0.57	$\text{MnO}_4^- + e \rightarrow \text{MnO}_4^{2-}$	+0.56
$\text{Si} + 4e \rightarrow \text{SiH}_4$	+0.10	$\text{O}_2 + 2e \rightarrow \text{H}_2\text{O}_2$	+0.68	$\text{Fe}^{3+} + e \rightarrow \text{Fe}^{2+}$	+0.77
$\text{C} + 4e \rightarrow \text{CH}_4$	+0.13	$\text{H}_2\text{SeO}_3 + 4e \rightarrow \text{Se}$	+0.74	$\text{Hg}_2^{2+} + 2e \rightarrow 2\text{Hg}$	+0.79
$\text{Sn}^{4+} + 2e \rightarrow \text{Sn}^{2+}$	+0.15	$\text{SeO}_4^{2-} + 2e \rightarrow \text{H}_2\text{SeO}_3$	+1.15	$2\text{Hg}^{2+} + 2e \rightarrow \text{Hg}_2^{2+}$	+0.92
$\text{PbO}_2 + 2e \rightarrow \text{PbSO}_4$	+1.69	$\frac{1}{2}\text{O}_2 + 2e \rightarrow \text{H}_2\text{O}$	+1.23	$\text{MnO}_2 + 2e \rightarrow \text{Mn}^{2+}$	+1.23
		$\text{H}_2\text{O}_2 + 2e \rightarrow 2\text{H}_2\text{O}$	+1.77	$\frac{1}{2}\text{Cr}_2\text{O}_7^{2-} + 3e \rightarrow \text{Cr}^{3+}$	+1.33
		$\text{S}_2\text{O}_8^{2-} + 2e \rightarrow 2\text{SO}_4^{2-}$	+2.01	$\text{MnO}_4^- + 5e \rightarrow \text{Mn}^{2+}$	+1.54
		$\text{O}_3 + 2e \rightarrow \text{O}_2$	+2.07	$\text{NiO}_2 + 2e \rightarrow \text{Ni}^{2+}$	+1.68
				$\text{MnO}_4^- + 3e \rightarrow \text{MnO}_2$	+1.70

Table 6.12 is a table of standard reduction potentials. From this table we can see that the standard reduction potential for  $\text{Cu}^{2+}/\text{Cu}$  is 0.35 V. What does this mean?

$\text{Cu}^{2+}/\text{Cu}$  is referred to as a redox couple and as written it refers to the half reaction (or electrode reaction)



In general, redox couples are written *ox/red* where *ox* is the oxidized form and is written on the left and *red* is the reduced form and is written on the right.

Standard reduction potential values are determined relative to a hydrogen electrode, that is the redox couple  $\text{H}^+/\text{H}_2$  at 25°C for 1 M concentrations (or one atmosphere pressure) of all chemical species in the equations. (The concentration of water is included in the constant.)

Thus,  $\text{Cu}^{2+}/\text{Cu}$   $E^\circ = +0.35$  V really means that the standard reduction potential of the reaction is 0.35 V.



Similarly the standard reduction potential of the couple  $\text{Zn}^{2+}/\text{Zn}$  is  $-0.76$  V.



Subtracting equation (6.2) from (6.1) gives



Both of the standard potentials are relative to the  $\text{H}^+/\text{H}_2$  couple and therefore  $\text{H}^+$  and  $\text{H}_2$  disappear when the  $\text{Cu}^{2+}/\text{Cu}$  couple is combined with the  $\text{Zn}^{2+}/\text{Zn}$  couple.

From experience the oxidized forms of couples of high positive potential, for example  $\text{MnO}_4^- + 5\text{e}^- \rightarrow \text{Mn}^{2+}$   $E^\circ = +1.54$  V, are termed strong oxidizing agents. Conversely the reduced forms of couples of high negative potential, for example  $\text{Li}^+ + \text{e}^- \rightarrow \text{Li}$   $E^\circ = -3.05$  V, are termed strong reducing agents. It follows that at some intermediate potential the oxidizing power of the oxidized form and the reducing power of the reduced form are similar. What is the value of this potential at which there is a change-over from oxidizing to reducing properties? The first point to note is that it is not at 0 V, the value assigned arbitrarily to the  $\text{H}^+/\text{H}$  couple: hydrogen is known to be a reducing agent. A group of chemical species which are used in classical (analytical) chemistry as weak reducing agents (e.g. sulphite and tin(II)) are the reduced forms of couples with potentials between 0 and about +0.6 V. On the other hand  $\text{VO}_2^+$  is the stable form of vanadium and  $\text{VO}_2^+$  is a weak oxidizing agent: the potential  $\text{VO}_2^+/\text{VO}^{2+}$  is +1.00 V. Thus from experience, as a general rule of thumb we can say that if  $E^\circ \approx 0.8$  V, then the oxidized and reduced forms are of about equal stability in redox processes.

It is not very discriminating to term a metal a reducing agent: most metals may be called reducing agents. It is useful to divide metals into four groups in regard to the ease of reduction of their metal ions.

1. The noble metals (with  $E^\circ$  more positive than 0 V).
2. Metals which are easily reduced (e.g. with coke) ( $E^\circ$  0 – (-0.5 V).
3. Typically reactive transition metals ( $E^\circ$  (-0.5) – (-1.5 V) which are often prepared by reduction with electropositive metals.
4. The electropositive metals ( $E^\circ$  more negative than -1.5 V) which can be prepared by electrochemical reduction.

When a solution is electrolysed the externally applied potential must overcome the electrode potential. The minimum voltage necessary to cause deposition is equal and opposite in sign to the potential between the solution and the electrode. Elements low down in the series discharge first; thus  $\text{Cu}^{2+}$  discharges before  $\text{H}^+$ , so copper may be electrolysed in aqueous solution. However, hydrogen and other gases often require a considerably higher voltage than the theoretical potential before they discharge. For hydrogen, this extra or over-voltage may be 0.8 volts, and thus it is possible to electrolyse zinc salts in aqueous solution.

Several factors affect the value of the standard potential. The conversion of  $\text{M}$  to  $\text{M}^+$  in aqueous solution may be considered in a series of steps:

1. sublimation of a solid metal
2. ionization of a gaseous metal atom
3. hydration of a gaseous ion

These are best considered in a Born-Haber type of cycle (Figure 6.4).

The enthalpy of sublimation and the ionization energy are positive since energy must be put into the system, and the enthalpy of hydration is negative since energy is evolved. Thus

$$E = +\Delta H_s + I - \Delta H_h$$

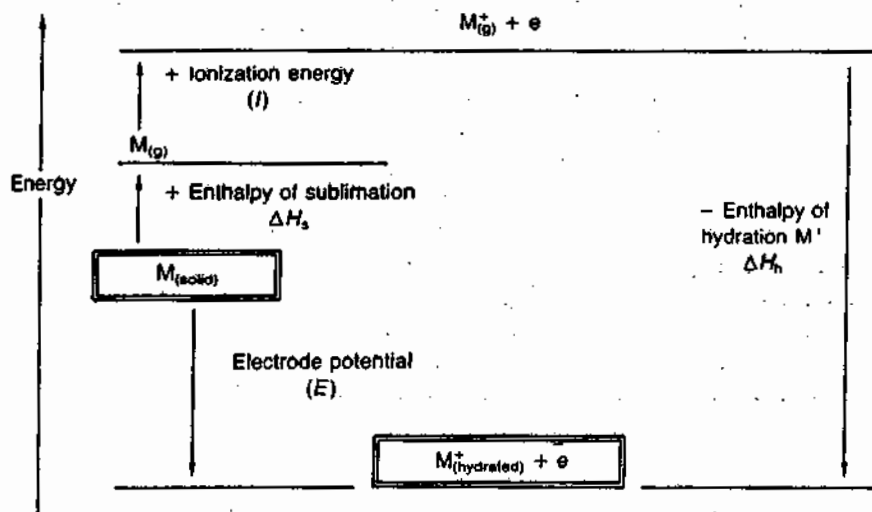

Figure 6.4 Energy cycle for electrode potentials.

Consider first a transition metal. Most transition metals have high melting points: hence the enthalpy of sublimation is high. Similarly they are fairly small atoms and have high ionization energies. Thus the value for the electrode potential  $E$  is low, and the metal has little tendency to form ions: hence it is unreactive or noble.

In contrast the  $s$ -block metals (Groups I and II) have low melting points (hence low enthalpies of sublimation), and the atoms are large and therefore have low ionization energies. Thus the electrode potential  $E$  is high and the metals are reactive.

Electrons are lost when a substance is oxidized and electrons are gained when it is reduced. A reducing agent must therefore supply electrons, and elements having large negative electrode potentials are strong reducing agents. The strengths of oxidizing and reducing agents may be measured by the size of the potential between a solution and an inert electrode. Standard reduction potentials are obtained when the concentrations of oxidized and reduced forms are 1 M, and the potential developed is measured against a standard hydrogen electrode. The most powerful oxidizing agents have a large positive oxidation potential and strong reducing agents have a large negative potential. Standard oxidation potentials allow us to predict which ions should oxidize or reduce other ions. The potentials indicate if the energy changes for the process are favourable or unfavourable. It is important to realize that though the potentials may suggest that a reaction is possible, they do not give any kinetic information concerning the rate of the reaction. The rate of the reaction may be very fast or slow, and in some cases a catalyst may be required for it to occur at all – for example in the oxidation of sodium arsenite by ceric sulphate.

### OXIDATION–REDUCTION REACTIONS

Oxidation is the removal of electrons from an atom, and reduction is the addition of electrons to an atom. The standard electrode potentials given in Table 6.10 are written by convention with the oxidized species on the left, and the reduced species on the right.



or



The potential developed by the half cell is therefore written as a reduction potential, since electron(s) are being added. A fuller list of reduction potentials in acid solution is given in Table 6.12.

Oxidation–reduction (redox) potentials can be used to great advantage in explaining oxidation–reduction reactions in aqueous solution. The reduction potential is related to energy by the equation:

$$\Delta G = -nFE^\circ$$

(where  $\Delta G$  is the change in Gibbs free energy,  $n$  the valency of the ion,  $F$  the Faraday and  $E^\circ$  the standard electrode potential). This is really an

application of thermodynamics. Ultimately whether a reaction occurs or not depends on energy. A reaction will not proceed if the free energy change  $\Delta G$  is positive, and thus thermodynamics saves us the trouble of trying the reaction. If  $\Delta G$  is negative, then the reaction is thermodynamically possible. It does not follow that because a reaction is thermodynamically possible, it will necessarily occur. Thermodynamics does not give any information on the rate of a reaction, which may be fast, slow, or infinitely slow, nor does it indicate if another reaction is even more favourable.

Consider the corrosion that may occur when a sheet of galvanized iron is scratched. (Galvanized iron is iron which has been coated with zinc to prevent rusting.) Half reactions and the corresponding reduction potentials are shown below.

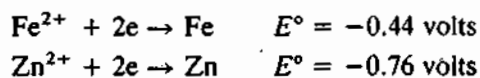

When in contact with water, either metal might be oxidized and lose metal ions, so we require the reverse reactions, and the potentials for these are called oxidation potentials, and have the same magnitude but the opposite sign to the reduction potentials.

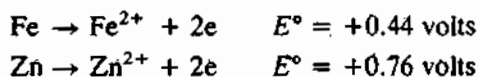

Plainly, since  $\text{Zn} \rightarrow \text{Zn}^{2+}$  produces the largest positive  $E^\circ$  value, and since  $\Delta G = nFE^\circ$ , it will produce the largest negative  $\Delta G$  value. Thus it is energetically more favourable for the Zn to dissolve, and hence the Zn will corrode away in preference to the Fe.

It is possible that when the galvanized steel is scratched, the air may oxidize some iron. The  $\text{Fe}^{2+}$  so produced is immediately reduced to iron by the zinc, and rusting does not occur.

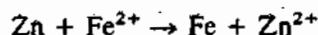

Similar applications in which one metal is sacrificed to protect another are the attaching of sacrificial blocks of magnesium to underground steel pipelines and the hulls of ships to prevent the rusting of iron.

Thus the coating of zinc serves two purposes – first it covers the iron and prevents its oxidation (rather like a coat of paint) and second it provides anodic protection.

A table of standard reduction potentials (Table 6.12) may be used to predict if a reaction is possible, and what the equilibrium constant will be. Consider for example if the triiodide ion  $\text{I}_3^-$  will oxidize As(III) in arsenious acid  $\text{HAsO}_2$  into As(V).

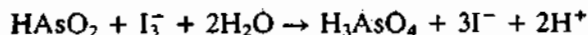

Since the table lists reduction potentials, we must find the half reactions for  $\text{H}_3\text{AsO}_4 + 2e \rightarrow$  products, and  $\text{I}_3^- + 2e \rightarrow$  products.

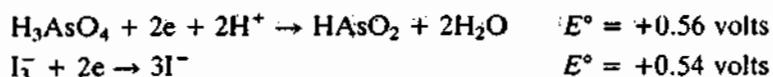

The reaction we are investigating requires the first half reaction in the reverse direction, added to the second half reaction.  $E^\circ$  values for half reactions must not be added together, since they do not take account of the number of electrons involved. However,  $E^\circ$  values may be converted to the corresponding  $\Delta G$  values, which may be added to give  $\Delta G$  for the overall reaction.

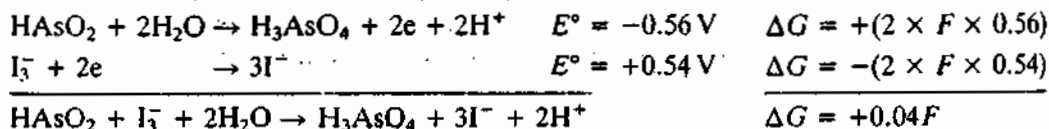

The  $\Delta G$  free energy change so calculated is positive, which indicates that the reaction will not proceed spontaneously in the forward direction, and suggests that it is energetically feasible for the reaction to proceed in the reverse direction. It should be noted that the value of  $\Delta G$  is very small, and thus it is unwise to draw very firm conclusions. The  $E^\circ$  values relate to standard conditions, and since  $\Delta G$  is small, a small change in conditions, such as varying the concentration, or the pH, or the temperature, could change the potentials and hence change  $\Delta G$  sufficiently to make the reaction proceed in either direction. There are volumetric methods of analysis for reducing arsenic acid with iodide ions in 5M acid, and for oxidizing arsenious acid by triiodide ion at pH 7.

### THE USE OF REDUCTION POTENTIALS

Enormous use may be made of reduction potentials for summarizing what species will oxidize or reduce something else, what the products of the reaction will be, and what oxidation states are stable with respect to the solvent, and also with respect to disproportionation. This topic is often insufficiently understood, so a number of examples are given.

A great deal of useful information about an element can be shown by the appropriate half reactions and reduction potentials. Consider some half reactions involving iron:

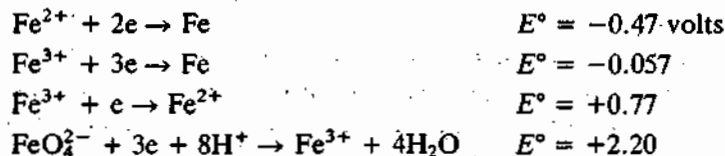

Where an element exists in several different oxidation states (in this case Fe(VI), Fe(III), Fe(II), and Fe(0)), it is convenient to display all of the reduction potentials for the half reactions in a single reduction potential diagram. In this the highest oxidation state is written at the left, and the

lowest state at the right, and species such as electrons,  $H^+$  and  $H_2O$  are omitted.

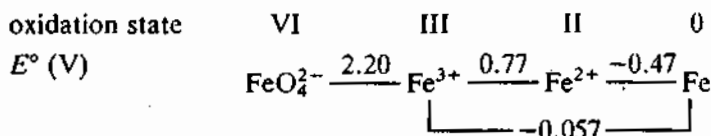

The potential for the reduction of  $FeO_4^{2-}$  to  $Fe^{3+}$  is +2.20 volts. Since  $\Delta G = -nFE^\circ$ , it follows that  $\Delta G$  for this change will be large and negative. This means that the reaction is thermodynamically possible since it releases a large amount of energy, and  $FeO_4^{2-}$  is a strong oxidizing agent.

Standard electrode potentials are measured on a scale with



Since hydrogen is normally regarded as a reducing agent, reactions with negative value for  $E^\circ$  are more strongly reducing than hydrogen, that is they are strongly reducing. Materials which are generally accepted as oxidizing agents have  $E^\circ$  values above +0.8 volts, those such as  $Fe^{3+} \rightarrow Fe^{2+}$  of about 0.8 volts are stable (equally oxidizing and reducing), and those below +0.8 volts become increasingly reducing.

For the change  $Fe^{3+}/Fe^{2+}$ ,  $E^\circ$  is +0.77 V. This is close to the value of 0.8 V, and therefore  $Fe^{3+}$  and  $Fe^{2+}$  are of almost equal stability with respect to oxidation and reduction. The  $E^\circ$  values for the changes  $Fe^{3+} \rightarrow Fe$  and for  $Fe^{2+} \rightarrow Fe$  are both negative: hence  $\Delta G$  is positive, so neither  $Fe^{3+}$  nor  $Fe^{2+}$  have any tendency to reduce to  $Fe$ .

One of the most important facts which can be obtained from a reduction potential diagram is whether any of the oxidation states are unstable with regard to disproportionation. Disproportionation is where one oxidation state decomposes, forming some ions in a higher oxidation state, and some in a lower oxidation state. This happens when a given oxidation state is a stronger oxidizing agent than the next highest oxidation state, and this situation occurs when a reduction potential on the right is more positive than one on the left. In the diagram of iron reduction potentials, the values become progressively more negative on moving from left to right, and hence  $Fe^{3+}$  and  $Fe^{2+}$  are stable with respect to disproportionation.

At first sight the potential of -0.057 V for  $Fe^{3+} \rightarrow Fe$  seems wrong since the potentials for  $Fe^{3+} \rightarrow Fe^{2+}$  and  $Fe^{2+} \rightarrow Fe$  are 0.77 V and -0.47 V respectively, and adding 0.77 and -0.47 does *not* give -0.057. Potentials for complete reactions may be added since there are no electrons left over in the process. Potentials may not be added for half reactions since the electrons may not balance. However, potentials can always be converted into free energies using the equation  $\Delta G = -nFE^\circ$  where  $n$  is the number of electrons involved and  $F$  is the Faraday. Since the Gibbs free energy  $G$  is a thermodynamic function, free energies may be added, and the final total free energy converted back to an  $E^\circ$  value:

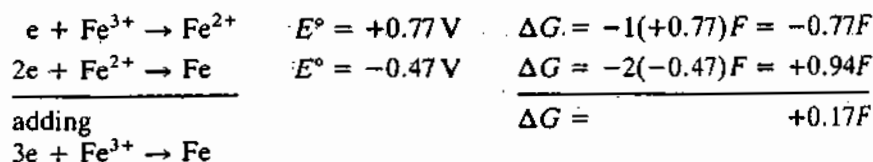

Hence  $E^\circ$  can be calculated for the reaction  $\text{Fe}^{3+} \rightarrow \text{Fe}$

$$E^\circ = \frac{\Delta G}{-nF} = \frac{0.17F}{-3F} = -0.057 \text{ V}$$

The reduction potential diagram for copper in acid solution is

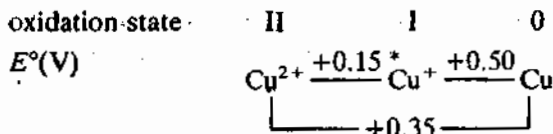

\* Disproportionates

The potential, and hence the energy released when  $\text{Cu}^{2+}$  is reduced to  $\text{Cu}^+$ , are both very small, and so  $\text{Cu}^{2+}$  is not an oxidizing agent but is stable. On moving from left to right the potentials  $\text{Cu}^{2+} - \text{Cu}^+ - \text{Cu}$  become more positive. Whenever this is found, the species in the middle ( $\text{Cu}^+$  in this case) disproportionates, that is it behaves as both a self-oxidizing and self-reducing agent because it is energetically favourable for the following two changes to occur together

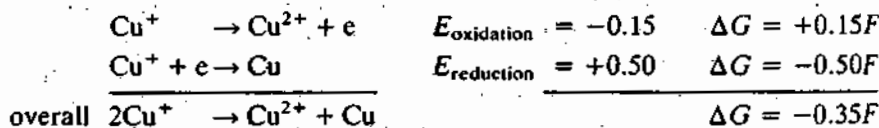

Thus in solution  $\text{Cu}^+$  disproportionates into  $\text{Cu}^{2+}$  and  $\text{Cu}$ , and hence  $\text{Cu}^+$  is only found in the solid state.

The reduction potential diagram for oxygen is shown.

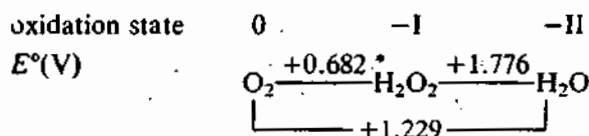

\* Disproportionates

On moving from left to right, the reduction potentials increase, and hence  $\text{H}_2\text{O}_2$  is unstable with respect to disproportionation.

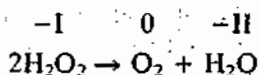

It must be remembered that the solvent may impose a limitation on what species are stable, or exist at all. Very strong oxidizing reagents will oxidize



water to  $O_2$ , whilst strong reducing agents will reduce it to  $H_2$ . Thus very strong oxidizing or reducing agents can not exist in aqueous solution. The following half reactions are of special importance:

*Reduction of water*

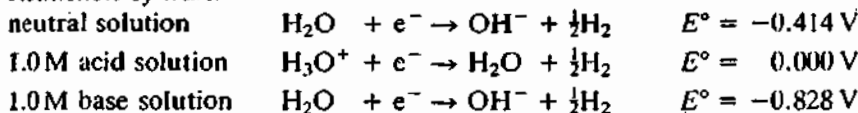

*Oxidation of water*

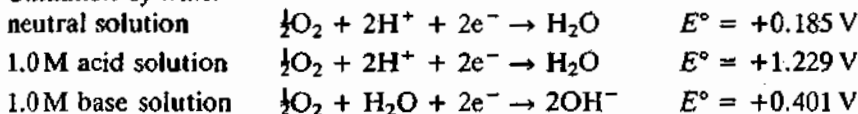

These reactions limit the *thermodynamic stability* of any species in aqueous solution.

Thus the minimum reduction potentials required to oxidize water to oxygen is  $E^\circ > +0.185 \text{ V}$  in neutral solution,  $E^\circ > +1.229 \text{ V}$  in 1.0M acid solution and  $E^\circ > +0.401 \text{ V}$  in 1.0M basic solution.

In the same way half reactions with  $E^\circ$  potentials less than zero (that is negative values) should reduce water to  $H_2$  in 1.0M acid solution, whilst an  $E^\circ < -0.414 \text{ V}$  is required in neutral solution, and  $E^\circ < -0.828 \text{ V}$  in 1.0M basic solution.

Often when the  $E^\circ$  values are just large enough to suggest that a reaction is thermodynamically possible, we find that it does not appear to happen. It must be remembered that a substance may be thermodynamically unstable, but kinetically stable, since the activation energy for the reaction is high. This means that the rates of these reactions are very slow. If the potentials are appreciably more positive or negative than these limits then reaction with the solvent is usually observed.

The reduction potentials for americium show that  $Am^{4+}$  is unstable with regard to disproportionation.

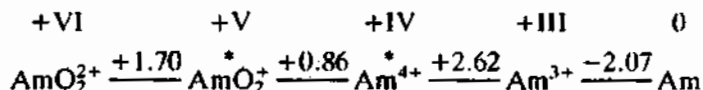

\* Disproportionates

The potential for the couple  $AmO_2^+ \rightarrow Am^{3+}$  can be calculated by converting the values of 0.86 and 2.62 volts into free energies, adding them, then converting back to give a potential of 1.74 volts. When this step is added to the diagram it becomes apparent that the potentials do not decrease from  $AmO_2^{2+}$  to  $AmO_2^+$  to  $Am^{3+}$ , and hence  $AmO_2^+$  is unstable with regard to disproportionation to  $AmO_2^{2+}$  and  $Am^{3+}$ . Finally, the potential for the couple  $AmO_2^{2+} \rightarrow Am^{3+}$  can be worked out to be +1.726 volts. Thus considering  $AmO_2^{2+} \rightarrow Am^{3+} \rightarrow Am$ ,  $Am^{3+}$  is stable:



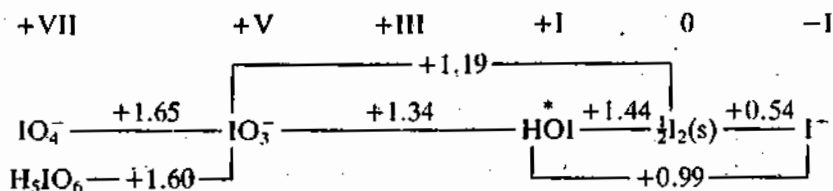
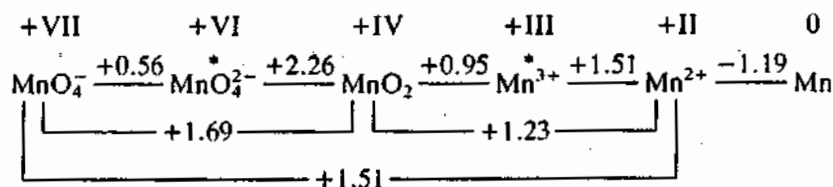

\* Disproportionates

If we assume that the reactions are thermodynamically controlled, that is equilibrium is reached fairly quickly, then since  $\text{MnO}_4^{2-}$ ,  $\text{Mn}^{3+}$  and  $\text{HOI}$  disproportionate, they need not be considered. The half reaction  $\text{Mn}^{2+} \rightarrow \text{Mn}$  has a large negative  $E^\circ$  value, and hence  $\Delta G$  will have a large positive value, so this will not occur, and can be ignored. Thus the reduction potential diagrams may be simplified:

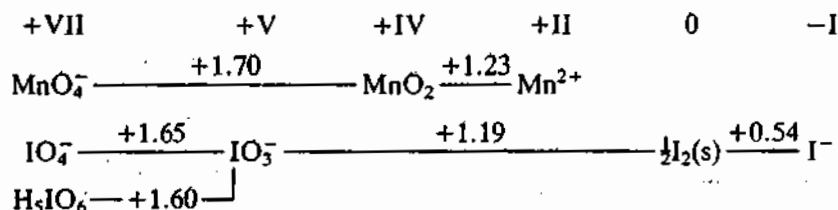

If the reaction is carried out by adding KI solution dropwise to an acidified solution of  $\text{KMnO}_4$ , the products of the reaction must be stable in the presence of  $\text{KMnO}_4$ . Thus  $\text{Mn}^{2+}$  cannot be formed, since  $\text{KMnO}_4$  would oxidize it to  $\text{MnO}_2$ . In a similar way,  $\text{I}_2$  cannot be formed, since  $\text{KMnO}_4$  would oxidize it. The fact that the half reaction potentials for  $\text{IO}_4^- \rightarrow \text{IO}_3^-$  and  $\text{H}_5\text{IO}_6 \rightarrow \text{IO}_3^-$  are close to the  $\text{MnO}_4^- \rightarrow \text{MnO}_2$  potential is a complication, and it is not obvious whether  $\text{IO}_3^-$ ,  $\text{IO}_4^-$  or  $\text{H}_5\text{IO}_6$  will be the product. In fact  $\text{I}^-$  is oxidized to a mixture of  $\text{IO}_3^-$  and  $\text{IO}_4^-$ .

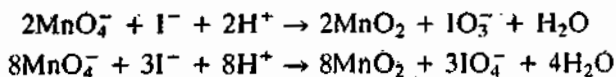

If the reaction is carried out in a different way, by adding the  $\text{KMnO}_4$  dropwise to the KI solution, then the products formed must be stable in the presence of  $\text{I}^-$ . Thus  $\text{MnO}_2$  cannot be formed, since it would oxidize  $\text{I}^-$  to  $\text{I}_2$ . Similarly,  $\text{IO}_3^-$  cannot be formed since it would oxidize any excess  $\text{I}^-$  to  $\text{I}_2$ . The reaction which takes place is

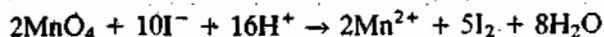

Since there is an excess of  $I^-$  ions, any  $I_2$  formed will dissolve as the triiodide ion  $I_3^-$ , but this does not affect the reaction

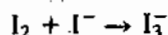

Note that the products formed depend on which reactant is in excess.

### THE OCCURRENCE AND ISOLATION OF THE ELEMENTS

The most abundant elements in the earth's crust (by weight) are shown in Table 6.13. It is worth noting that the first five elements comprise almost 92% by weight of the earth's crust, that the first ten make up over 99.5%, and the first twenty make up 99.97%. Thus a few elements are very abundant but most of the elements are very scarce.

Table 6.13 The most abundant elements

	Parts per million of earth's crust	% of earth's crust
1. oxygen	455 000	45.5
2. silicon	272 000	27.2
3. aluminium	83 000	8.3
4. iron	62 000	6.2
5. calcium	46 000	4.66
6. magnesium	27 640	2.764
7. sodium	22 700	2.27
8. potassium	18 400	1.84
9. titanium	6 320	0.632
10. hydrogen	1 520	0.152
11. phosphorus	1 120	0.112
12. manganese	1 060	0.106

A full table of abundances is given in Appendix A.

Other very abundant elements are nitrogen (78% of the atmosphere) and hydrogen, which occurs as water in the oceans. The chemistry of these abundant elements is well known, but some elements which are rare are also well known, because they occur in concentrated deposits – for example, lead as  $PbS$  (galena) and boron as  $Na_2B_4O_7 \cdot 10H_2O$  (borax).

The different methods for separating and extracting elements may be divided into five classes (see Ives, D.J.G. in Further Reading).

#### Mechanical separation of elements that exist in the native form

A surprisingly large number of elements occur in the free elemental state. They have remained in the native form because they are unreactive. Only the least reactive of the metals, those of the copper/silver/gold group and the platinum metals, occur in significant amounts as native elements.

1. Gold is found in the native form, as grains in quartz, as nuggets and in the silt of river beds. Gold has a density of  $19.3 \text{ g cm}^{-3}$ , which is very

much higher than that of the rocks or silt it is mixed with, and gold can be separated by 'panning'. (In recent times it has been more commonly extracted by amalgamating with mercury.) Silver and copper are some times found in the native form as 'nuggets'. All three metals are noble or unreactive, and this is associated with their position in the electrochemical series below hydrogen, and with the non-metals.

2. Palladium and platinum are also found as native metals. In addition natural alloys of the Pt group are found.

The platinum metals are    Ru   Rh   Pd  
   Os   Ir   Pt

The names of these natural alloys indicate their composition: osmidium, iridosmine.

3. Liquid droplets of mercury are found associated with cinnabar  $\text{HgS}$ . Non-metals which occur as native elements in the earth's crust are from the carbon and sulphur groups, but the atmosphere comprises  $\text{N}_2$ ,  $\text{O}_2$  and the noble gases.
4. Diamonds are found in the earth, and are obtained by mechanical separation of large amounts of earth and rock. The largest deposits are in Australia, Zaire, Botswana, the USSR and South Africa. Diamonds are mostly used for making cutting tools, and some for jewellery. Graphite is mined mainly in China, South Korea, the USSR, Brazil and Mexico. It is used for making electrodes, in steel making, as a lubricant, and in pencils, brake linings and brushes for electric motors. It is also used as the moderator in the cores of gas cooled nuclear reactors.
5. Deposits of sulphur are also found deep underground in Louisiana (USA), Poland, Mexico and the USSR. These are extracted by the *Frasch process*. Small amounts of selenium and tellurium are often present in sulphur.
6. The atmosphere is made up of about 78% nitrogen, 22% oxygen and traces of the noble gases argon, helium and neon. These may be separated by fractional distillation of liquid air. Helium is also obtained from some natural gas deposits.

### Thermal decomposition methods

A few compounds will decompose into their constituent elements simply by heating.

1. A number of hydrides will decompose in this way, but since hydrides are usually made from the metal itself, the process is of no commercial significance. The hydrides arsine  $\text{AsH}_3$  and stibine  $\text{SbH}_3$  are produced in Marsh's test, where an arsenic or antimony compound is converted to the hydride with  $\text{Zn}/\text{H}_2\text{SO}_4$  and the gaseous hydrides are decomposed to give a silvery mirror of metal by passing the hydride through a heated tube.
2. Sodium azide  $\text{NaN}_3$  decomposes to give sodium and pure nitrogen on

*gentle heating*. Considerable care is needed as azides are often explosive. This method is not used commercially, but it is useful for making small quantities of very pure nitrogen in the laboratory.

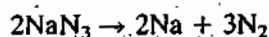

3. Nickel carbonyl  $\text{Ni}(\text{CO})_4$  is gaseous and may be produced by warming Ni with CO at  $50^\circ\text{C}$ . Any impurities in the Ni sample remain solid and the gas is heated to  $230^\circ\text{C}$ , when it decomposes to give pure metal and CO which is recycled. This was the basis of the *Mond process* for purifying nickel which was used in South Wales from 1899 until the 1960s. A new plant in Canada uses the same principle but uses  $150^\circ\text{C}$  and 20 atmospheres pressure to form  $\text{Ni}(\text{CO})_4$ .



4. The iodides are the least stable of the halides, and the *van Arkel-de Boer process* has been used to purify small quantities of zirconium and boron. The impure element is heated with iodine, producing a volatile iodide  $\text{ZrI}_4$  or  $\text{BI}_3$ . These are decomposed by passing the gas over an electrically heated filament of tungsten or tantalum which is white hot. The element is deposited on the filament and the iodine is recycled. The filament grows fatter, and is eventually removed. The tungsten core is drilled out of the centre, and a small amount of high purity Zr or B is obtained.
5. Most oxides are thermally stable at temperatures up to  $1000^\circ\text{C}$  but the metals below hydrogen in the electrochemical series decompose fairly easily. Thus  $\text{HgO}$  and  $\text{Ag}_2\text{O}$  decompose on heating. The mineral cinnabar  $\text{HgS}$  is roasted in air to give the oxide, which then decomposes on heating. Silver residues from the laboratory and photographic processing are collected as  $\text{AgCl}$  and treated with  $\text{Na}_2\text{CO}_3$ , giving  $\text{Ag}_2\text{CO}_3$ , which decomposes on heating, first to  $\text{Ag}_2\text{O}$  and then to Ag.

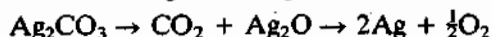
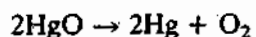

6. Oxygen may be produced by heating hydrogen peroxide  $\text{H}_2\text{O}_2$ , barium peroxide  $\text{BaO}_2$ , silver oxide  $\text{Ag}_2\text{O}$  or potassium chlorate  $\text{KClO}_3$ .

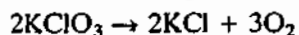
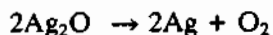
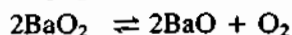
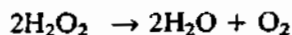

#### Displacement of one element by another

In principle any element may be displaced from solution by another element which is higher in the electrochemical series. The method is in-

applicable to elements which react with water, and to be economic must involve sacrificing a cheap element to obtain a more expensive element.

1. Copper ores which are too lean in CuS for the Cu to be extracted by roasting in air are left to be weathered by air and rain to form a solution of  $\text{CuSO}_4$ . The  $\text{Cu}^{2+}$  ions are displaced as Cu metal by sacrificing scrap iron which turns into  $\text{Fe}^{2+}$  because iron is above copper in the electrochemical series.

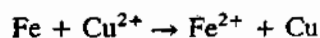

2. Cadmium occurs in small amounts with zinc ores. The Zn is recovered by electrolysing a solution of  $\text{ZnSO}_4$  which contains traces of  $\text{CdSO}_4$ . After a time the amount of  $\text{Cd}^{2+}$  has concentrated, and since Zn is above Cd in the electrochemical series some Zn metal is sacrificed to displace the  $\text{Cd}^{2+}$  from solution as Cd metal. The Zn which was sacrificed is subsequently recovered by electrolysis.



3. Sea water contains  $\text{Br}^-$  ions. Chlorine is above bromine in the electrochemical series, and bromine is obtained by passing chlorine into sea water.

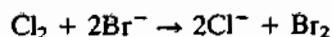

### High temperature chemical reduction methods

A large number of commercial processes come into this group. Carbon can be used to reduce a number of oxides and other compounds, and because of the low cost and availability of coke this method is widely used. The disadvantages are that a high temperature is needed, which is expensive and necessitates the use of a blast furnace, and many metals combine with carbon, forming carbides. Some examples are:

#### *Reduction by carbon*

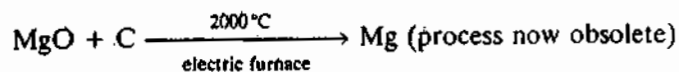
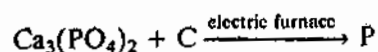
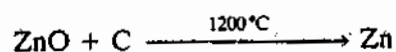
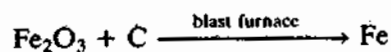

*Reduction by another metal*

If the temperature needed for carbon to reduce an oxide is too high for economic or practical purposes, the reduction may be effected by another highly electropositive metal such as aluminium, which liberates a large amount of energy ( $1675 \text{ kJ mol}^{-1}$ ) on oxidation to  $\text{Al}_2\text{O}_3$ . This is the basis of the *Thermite process*:

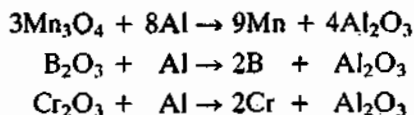

Magnesium is used in a similar way to reduce oxides. In certain cases where the oxide is too stable to reduce, electropositive metals are used to reduce halides.

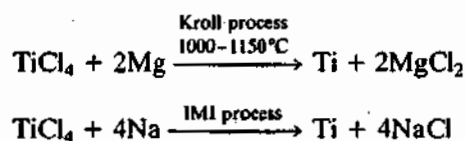
*Self-reduction*

A number of metals occur as sulphide ores (for example  $\text{PbS}$ ,  $\text{CuS}$  and  $\text{Sb}_2\text{S}_3$ ) which may be roasted first in air to partially convert them to the oxide, and then further roasted in the absence of air, causing self-reduction:

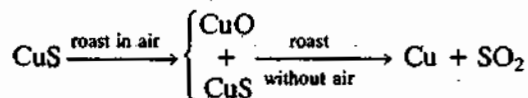
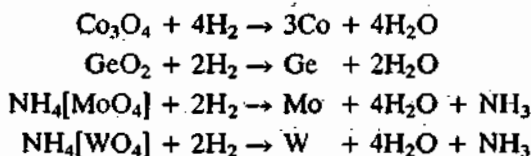
*Reduction of oxides with hydrogen*

This method is not widely used, because many metals react with hydrogen at elevated temperatures, forming hydrides. There is also a risk of explosion from hydrogen and oxygen in the air.

*Electrolytic reduction*

The strongest possible reducing agent is an electron. Any ionic material may be electrolysed, and reduction occurs at the cathode. This is an excellent method, and gives very pure products, but electricity is expensive. Electrolysis may be performed:



*In aqueous solution*

Provided that the products do not react with water, electrolysis can be carried out conveniently and cheaply in aqueous solution. Copper and zinc are obtained by electrolysis of aqueous solutions of their sulphates.

*In other solvents*

Electrolysis can be carried out in solvents other than water. Fluorine reacts violently with water, and it is produced by electrolysis of  $\text{KHF}_2$  dissolved in anhydrous HF. (The reaction has many technical difficulties in that HF is corrosive, the hydrogen produced at the cathode must be kept separate from the fluorine produced at the anode or an explosion will occur, water must be rigorously excluded, and the fluorine produced attacks the anode and the reaction vessel.)

*In fused melts*

Elements that react with water are often extracted from fused melts of their ionic salts. These melts are frequently corrosive, and involve large fuel bills to maintain the high temperatures required. Aluminium is obtained by electrolysis of a fused mixture of  $\text{Al}_2\text{O}_3$  and cryolite  $\text{Na}_3[\text{AlF}_6]$ . Both sodium and chlorine are obtained from the electrolysis of fused  $\text{NaCl}$ : in this case up to two thirds by weight of  $\text{CaCl}_2$  is added as an impurity to lower the melting point from  $803^\circ\text{C}$  to  $505^\circ\text{C}$ .

**Factors influencing the choice of extraction process**

The type of process used commercially for any particular element depends on a number of factors.

1. Is the element unreactive enough to exist in the free state?
2. Are any of its compounds unstable to heat?
3. Does the element exist as an ionic compound, and is the element stable in water? If both are true, is there a cheap element above it in the electrochemical series which can be sacrificed to displace it from solution?
4. Does the element occur as sulphide ores which can be roasted, or oxide ores which can be reduced – using carbon is the cheapest whilst the use of Mg, Al and Na as reducing agents is more expensive.
5. If all other methods fail, electrolysis usually works for ionic materials, but is expensive. If the element is stable in water, electrolysis of aqueous solutions is cheaper than using fused melts.

**Thermodynamics of reduction processes**

The extraction of metals from their oxides using carbon or other metals, and by thermal decomposition, involves a number of points which merit detailed discussion.

Table 6.14 Reduction potentials and extraction methods

Element	$E^\circ$ (V)	Materials	Extraction method
Lithium	$\text{Li}^+   \text{Li}$ -3.05	LiCl	Electrolysis of fused salts, usually chlorides
Potassium	$\text{K}^+   \text{K}$ -2.93	KCl, $[\text{KCl} \cdot \text{MgCl}_2 \cdot 6\text{H}_2\text{O}]$	
Calcium	$\text{Ca}^{2+}   \text{Ca}$ -2.84	$\text{CaCl}_2$	
Sodium	$\text{Na}^+   \text{Na}$ -2.71	NaCl	
Magnesium	$\text{Mg}^{2+}   \text{Mg}$ -2.37	$\text{MgCl}_2$ , MgO	Electrolysis of $\text{MgCl}_2$ High temperature reduction with C
Aluminium	$\text{Al}^{3+}   \text{Al}$ -1.66	$\text{Al}_2\text{O}_3$	Electrolysis of $\text{Al}_2\text{O}_3$ dissolved in molten $\text{Na}_3[\text{AlF}_6]$
Manganese	$\text{Mn}^{2+}   \text{Mn}$ -1.08	$\text{Mn}_3\text{O}_4$ , $\text{MnO}_2$	Reduction with Al Thermite process
Chromium	$\text{Cr}^{3+}   \text{Cr}$ -0.74	$\text{FeCr}_2\text{O}_4$	
Zinc	$\text{Zn}^{2+}   \text{Zn}$ -0.76	ZnS	Chemical reduction of oxides by C Sulphides are converted to oxides then reduced by C, or sometimes $\text{H}_2$
Iron	$\text{Fe}^{2+}   \text{Fe}$ -0.44	$\text{Fe}_2\text{O}_3$ , $\text{Fe}_3\text{O}_4$	
Cobalt	$\text{Co}^{2+}   \text{Co}$ -0.27	CoS	
Nickel	$\text{Ni}^{2+}   \text{Ni}$ -0.23	NiS, NiAs <sub>2</sub>	
Tin	$\text{Sn}^{2+}   \text{Sn}$ -0.14	$\text{SnO}_2$	
Lead	$\text{Pb}^{2+}   \text{Pb}$ -0.13	PbS	Found as native metal, or compounds easily decomposed by heat. (Also cyanide extraction)
Copper	$\text{Cu}^{2+}   \text{Cu}$ +0.35	Cu(metal), CuS	
Silver	$\text{Ag}^+   \text{Ag}$ +0.80	Ag(metal), $\text{Ag}_2\text{S}$ , AgCl	
Mercury	$\text{Hg}^{2+}   \text{Hg}$ +0.85	HgS	
Gold	$\text{Au}^{3+}   \text{Au}$ +1.38	Au(metal)	

For a spontaneous reaction, the free energy change  $\Delta G$  must be negative.

$$\Delta G = \Delta H - T\Delta S$$

$\Delta H$  is the enthalpy change during the reaction,  $T$  is the absolute temperature, and  $\Delta S$  is the change in entropy during the reaction. Consider a reaction such as the formation of an oxide:

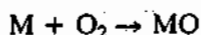

Oxygen is used up in the course of this reaction. Gases have a more random structure (less ordered) than liquids or solids. Consequently gases have a higher entropy than liquids or solids. In this reaction  $S$  the entropy or randomness decreases, and hence  $\Delta S$  is negative. Thus if the temperature is raised then  $T\Delta S$  becomes more negative. Since  $T\Delta S$  is subtracted in the equation, then  $\Delta G$  becomes less negative. Thus the free energy change decreases with an increase of temperature.

The free energy changes that occur when one gram molecule of a

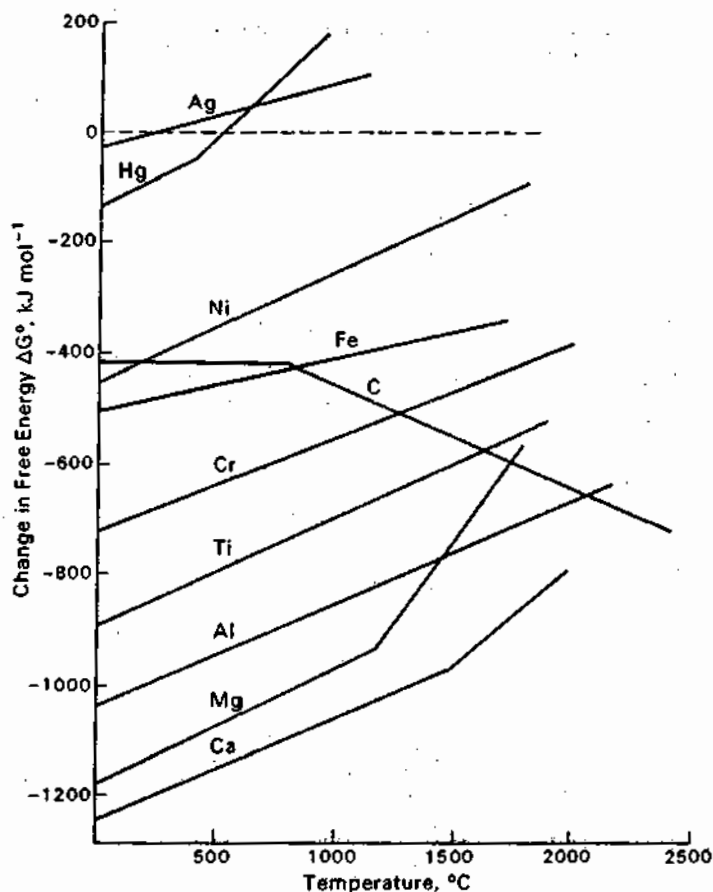

Figure 6.5 Ellingham diagram showing the change in free energy  $\Delta G$  with temperature for oxides (based on 1 g mol of oxygen in each case).

common reactant (in this case oxygen) is used may be plotted graphically against temperature for a number of reactions of metals to their oxides. This graph is shown in Figure 6.5 and is called an Ellingham diagram (for oxides). Similar diagrams can be produced for one gram molecule of sulphur, giving an Ellingham diagram for sulphides, and similarly for halides.

The Ellingham diagram for oxides shows several important features:

1. The graphs for metal to metal oxide all slope upwards, because the free energy change decreases with an increase of temperature as discussed above.
2. The free energy changes all follow a straight line unless the materials melt or vaporize, when there is a large change in entropy associated with the change of state, which changes the slope of the line (for example the Hg-HgO line changes slope at 356°C when Hg boils, and similarly Mg-MgO changes at 1120°C).

3. When the temperature is raised, a point will be reached where, the graph crosses the  $\Delta G = 0$  line. Below this temperature the free energy of formation of the oxide is negative, so the oxide is stable. Above this temperature the free energy of formation of the oxide is positive, and the oxide becomes unstable, and should decompose into the metal and oxygen.

Theoretically all oxides can be decomposed to give the metal and oxygen if a sufficiently high temperature can be attained. In practice the oxides of Ag, Au and Hg are the only oxides which can be decomposed at temperatures which are easily attainable, and these metals can therefore be extracted by thermal decomposition of their oxides.

4. In a number of processes, one metal is used to reduce the oxide of another metal. Any metal will reduce the oxide of other metals which lie above it in the Ellingham diagram because the free energy will become more negative by an amount equal to the difference between the two graphs at that particular temperature. Thus Al reduces FeO, CrO and NiO in the well known Thermite reaction, but Al will not reduce MgO at temperatures below  $1500^{\circ}\text{C}$ .

In the case of carbon reacting with oxygen, two reactions are possible:

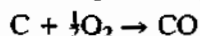
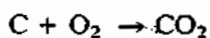

In the first reaction, the volume of  $\text{CO}_2$  produced is the same as the volume of  $\text{O}_2$  used, so the change in entropy is very small, and  $\Delta G$  hardly changes with temperature. Thus the graph of  $\Delta G$  against  $T$  is almost horizontal.

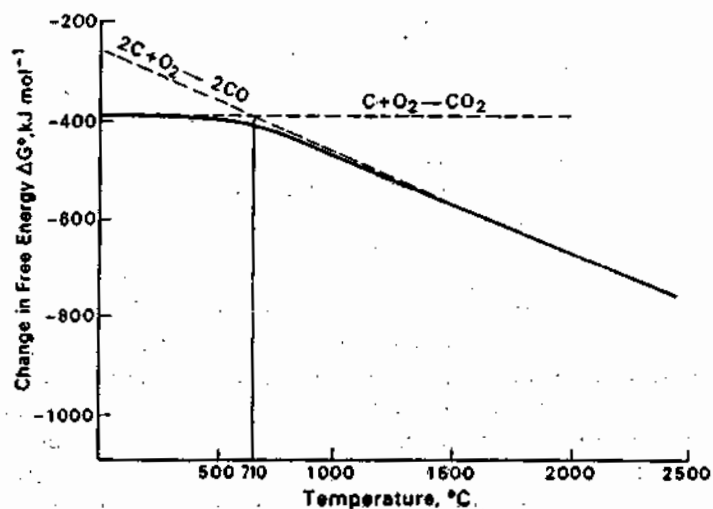
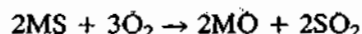

Figure 6.6 Ellingham diagram for carbon. (The composite curve is the solid line.)

The second reaction produces two volumes of CO for every one volume of oxygen used. Thus  $\Delta S$  is positive, and hence  $\Delta G$  becomes increasingly negative as  $T$  increases. Consequently the line on the Ellingham diagram slopes downwards (Figure 6.6). The two lines for  $C \rightarrow CO_2$  and  $C \rightarrow CO$  cross at about  $710^\circ C$ . Below this temperature the reaction to form  $CO_2$  is energetically more favourable, but above  $710^\circ C$  the formation of CO is preferred.

Carbon is extensively used to reduce iron oxide in the extraction of iron, but it may also be used to reduce any other of the oxides above it on the Ellingham diagram. Since the  $\Delta G$  line slopes downwards it will eventually cross and lie below all the other graphs for metal/metal oxide. Thus in principle carbon could be used to reduce any metal oxide if a sufficiently high temperature were used. At one time MgO was reduced by C at  $2000^\circ C$ , followed by shock (i.e. rapid) cooling, though this process is now obsolete. Similarly the reduction of very stable oxides like  $TiO_2$ ,  $Al_2O_3$  and MgO is theoretically possible, but is not attempted because of the high cost and practical difficulties of using extremely high temperatures. A further limitation on the use of carbon for extracting metals is that at high temperatures many metals react with carbon, forming carbides.

Many metals occur as sulphide ores. Though carbon is a good reducing agent for oxides, it is a poor reducing agent for sulphides. The reason why carbon reduces so many oxides at elevated temperatures is that the  $\Delta G^\circ/T$  line for CO has a negative slope. There is no compound CS analogous to CO with a steep negative  $\Delta G^\circ/T$  line. Thus sulphides are normally roasted in air to form oxides before reducing with carbon.



In a similar way hydrogen is of limited use as a reducing agent for extracting metals from their oxides since the  $\Delta G^\circ/T$  line has a positive slope, and runs parallel to many metal oxide lines.



Thus only those metals with metal  $\rightarrow$  metal oxide lines above the hydrogen line will be reduced, and this does not change with temperature. A further problem with  $H_2$  is that many metals react with hydrogen, forming hydrides, and if hydrogen remains dissolved in the metal (interstitial hydrides) it significantly affects the properties of the metal.

Thermodynamic arguments about what will reduce a given compound have two limitations. They assume that the reactants and products are in equilibrium, which is often untrue, and they indicate whether a reaction is possible but do not predict the rate of reaction, or if some alternative reaction is even more favourable.

Further details of extraction processes and Ellingham diagrams for halides and sulphides are given in Further Reading see Ives D.J.G., and Ellingham, H.J.T.

Table 6.15 Extraction methods and the periodic table

Group \ Period	s-block		p-block													
	I	II	III	IV	V	VI	VII	0								
1	<sup>1</sup> H		Fractional distillation of liquid air													
2	<sup>3</sup> Li	<sup>4</sup> Be	<sup>5</sup> B									<sup>9</sup> F				
3	<sup>11</sup> Na	<sup>12</sup> Mg	d-block							<sup>13</sup> Al	<sup>14</sup> Si	<sup>15</sup> P		<sup>17</sup> Cl		
4	<sup>19</sup> K	<sup>20</sup> Ca	<sup>21</sup> Sc				<sup>26</sup> Fe	<sup>27</sup> Co	<sup>28</sup> Ni	<sup>29</sup> Cu	<sup>30</sup> Zn	<sup>31</sup> Ga	<sup>32</sup> Ge	<sup>33</sup> As	<sup>34</sup> Se	<sup>35</sup> Br
5	<sup>37</sup> Rb	<sup>38</sup> Sr	<sup>39</sup> Y			<sup>42</sup> Mo	<sup>43</sup> Tc				<sup>48</sup> Cd	<sup>49</sup> In	<sup>50</sup> Sn	<sup>51</sup> Sb	<sup>52</sup> Te	<sup>53</sup> I
6	<sup>55</sup> Cs	<sup>56</sup> Ba	<sup>57</sup> La			<sup>74</sup> W	<sup>75</sup> Re				<sup>80</sup> Hg	<sup>81</sup> Tl	<sup>82</sup> Pb	<sup>83</sup> Bi		

Electrolysis of fused salts (often chlorides)

Electrolysis or chemical reduction

Found free in nature or compounds easily decomposed by heat

Oxides reduced by carbon or sulphides converted to oxides then reduced by carbon

Notes

1. Al, F and Cl are obtained by electrolysis of solutions
2. Br is obtained by displacement
3. I is obtained by reduction
4. Tc does not occur in nature

### HORIZONTAL, VERTICAL AND DIAGONAL RELATIONSHIPS IN THE PERIODIC TABLE

On moving across a period in the periodic table, the number of electrons in the outer shell increases from one to eight. Thus Group I elements all have one electron in their outer shell. When they react they are univalent, because the loss of one electron leaves a noble gas structure. Similarly Group II elements have two electrons in their outer shell and are divalent. The valency of an element in one of the main groups is either the group number, which is the same as the number of outer electrons, or eight minus the group number. Group V elements (e.g. nitrogen) have five outer electrons. If three of these are shared in covalent bonds with other atoms, the nitrogen atom has a share in eight electrons and has a stable configuration. Thus nitrogen is trivalent, for example in ammonia  $\text{NH}_3$ . The halogens are in Group VII and have seven outer electrons. The valency should be  $8 - 7 = 1$ . A stable structure is attained by gaining one electron either by forming an ionic or a covalent bond. The number of outer electrons thus determines the valency of the element.

On moving from left to right across a period, the size of the atoms decreases because of the additional nuclear charge. Thus the orbital electrons are more tightly held, and the ionization energy increases. The metallic character of the element also decreases, and the oxides of the elements become less basic. Thus  $\text{Na}_2\text{O}$  is strongly basic;  $\text{Al}_2\text{O}_3$  is amphoteric and reacts with both acids and bases;  $\text{SO}_2$  is an acidic oxide since it dissolves in water to form sulphurous acid ( $\text{H}_2\text{SO}_3$ ) and reacts with bases to form sulphites. Generally, metallic oxides are basic, whilst non-metallic oxides are acidic.

On descending a group in the periodic table, the elements all have the same number of outer electrons and the same valency, but the size increases. Thus the ionization energy decreases and the metallic character increases. This is particularly apparent in Groups IV and V which begin with the non-metals carbon and nitrogen and end with the metals lead and bismuth. The oxides become increasingly basic on descending the group.

On moving diagonally across the periodic table the elements show certain similarities. These are usually weaker than the similarities within a group, but are quite pronounced in the following pairs of elements:

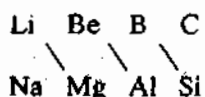

On moving across a period, the charge on the ions increases and the size decreases, causing the polarizing power to increase. On moving down a group, the size increases and the polarizing power decreases. On moving diagonally these two effects partly cancel each other, so that there is no marked change in properties. The type and strength of bond formed and the properties of the compounds are often similar, although the valency is different. Thus lithium is similar to magnesium in many of its properties

and beryllium is similar to aluminium. These similarities are examined in more detail in the chapters on Groups I, II and III. Diagonal similarities are most important among the lighter elements, but the line separating the metals from the non-metals also runs diagonally.

#### FURTHER READING

##### Size, ionization energy, electron affinity, energetics and Born–Haber cycle, electronegativity

- Allred, A.L. and Rochow, E.G. (1958) *J. Inorg. Nucl. Chem.*, **5**, 264. (Original paper on Allred and Rochow scale of electronegativity values.)
- Allred, A.L. (1961) *J. Inorg. Nucl. Chem.*, **17**, 215. (More on electronegativity values.)
- Ashcroft, S.J. and Beech, G. (1973) *Inorganic Thermodynamics*, Van Nostrand.
- Bratsch, S.G. (1988) Revised Mulliken electronegativities, *J. Chem. Ed.*, Part I: **65**, 34–41; Part II: **65**, 223–226.
- Blustin, P.H. and Raynes, W.T. (1981) An electronegativity scale based on geometry changes on ionization, *J. Chem. Soc. (Dalton)*, 1237.
- Emeléus, H.J. and Sharpe A.G. (1973) *Modern Aspects of Inorganic Chemistry*, 4th ed., (Chapter 5: Structures and energetics of inorganic molecules; Chapter 6: Inorganic chemistry in aqueous media), Routledge and Kegan Paul, London.
- Huheey, J.E. (1972) *Inorganic Chemistry*, Harper and Row, New York. (Discussion on electronegativity.)
- Lieberman, J.F. (1973) Ionization enthalpies and electron attachment enthalpies, *J. Chem. Ed.*, **50**, 831.
- Mulliken, R.S. (1934, 1935) *J. Chem. Phys.*, **2**, 782; **3**, 573. (Mulliken electronegativity scale.)
- Pauling, L. (1960) *The Nature of the Chemical Bond*, 3rd ed., Oxford University Press, London. (An old but classic text.)
- Sanderson, R.T. (1945) A scale of electronegativity, *J. Chem. Ed.*, **31**, 2. (Original paper on Sanderson electronegativity scale.)
- Sanderson, R.T. (1986) The Inert Pair Effect and Electronegativity, *Inorganic Chemistry*, **25**, 1856–1858.
- Sanderson, R.T. (1988) Principles of electronegativity, *J. Chem. Ed.*, Part I: **65**, 112–118; Part II: **65**, 227–231.
- Shannon, R.D. (1976) Revised effective ionic radii, *Acta Cryst.*, **A32**, 751–767. (The most recent and widely accepted values for ionic radii.)
- Sharpe, A.G. (1981) *Inorganic Chemistry* (Chapter 3: Electronic configurations and some physical properties of atoms.), Longmans, London.
- Zhang, Y. (1982) Electronegativities of elements in valence states, *Inorganic Chemistry*, **21**, 3886–3889.

##### Standard electrode potentials, redox reactions

- Baes, C.F. and Mesmer, R.E. (1976) *The Hydrolysis of Cations*, Wiley-Interscience, London, 1976. (Comprehensive but understandable.)
- Bard, A.J., Parsons, R. and Jordan, J. (1985) *Standard Potentials in Aqueous Solution* (Monographs in Electroanalytical Chemistry and Electrochemistry Series, Vol. 6), Marcel Dekker, New York. (Commissioned by IUPAC to replace the earlier values in Latimer's book.)
- Burgess, J. (1988) *Ions in Solution*, Ellis-Horwood, Chichester.
- Fromhold, A.T., Jr (1980) *Theory of Metal Oxidation*, North Holland Publishing Co., Amsterdam and Oxford.



- Jolly, W.L. (1976) *Inorganic Chemistry*, McGraw Hill, New York. (Redox reactions, and aqueous solutions.)
- Johnson, D.A. (1968) *Some Thermodynamic Aspects of Inorganic Chemistry*, Cambridge University Press, Cambridge. (Lattice energies etc.)
- Latimer, W.M. (1952) *The Oxidation States of the Elements and Their Potentials in Aqueous Solution*, 2nd ed., Prentice Hall, New York. (Old, but until very recently the standard source of oxidation potential data.)
- Rosotti, H. (1978) *The Study of Ionic Equilibria in Aqueous Solution*, Longmans, London. (Redox reactions, solubility.)
- Sanderson, R.T. (1966) The significance of electrode potentials, *J. Chem. Ed.*, 43, 584-586.
- Sharpe, A.G. (1969) *Principles of Oxidation and Reduction* (Royal Institute of Chemistry Monographs for Teachers No. 2), London.
- Sharpe A.G. (1981) *Inorganic Chemistry*, (Chapter 7: Inorganic chemistry in aqueous media), Longmans, London.
- Vincent, A. (1985) *Oxidation and Reduction in Inorganic and Analytical Chemistry: A Programmed Introduction*, John Wiley, Chichester.

#### Abundance and extraction of the elements

- Cox, P.A. (1989) *The Elements: Their origins, Abundance and Distribution*, Oxford University Press, Oxford.
- Ellingham, H.J.T. (1944, 1948) *J. Soc. Chem. Ind. Lond.*, 63, 125; *Disc. Faraday Soc.*, 4, 126, 161. (Original paper on Ellingham diagrams.)
- Fergusson, J.E. (1982) *Inorganic Chemistry and the Earth: Chemical Resources, Their Extraction, Use and Environmental Impact* (Pergamon Series on Environmental Science, Vol. 6), Pergamon Press, Oxford.
- Ives, D.J.G. (1969) *Principles of the Extraction of Metals* (Royal Institute of Chemistry Monographs for Teachers No. 3), London.
- Jeffes, J.H.E. (1969) Extraction Metallurgy, *Chemistry in Britain*, 5, 189-192.

#### PROBLEMS

- How does the size of atoms vary from left to right in a period, and on descending a group in the periodic table? What are the reasons for these changes?
  - Can you explain the large atomic radii of the noble gases?
  - Why is the decrease in size between Li and Be much greater than that between Na and Mg or K and Ca?
- Explain what is meant by the ionization energy of an element. How does this vary between hydrogen and neon in the periodic table? Discuss how the variation can be related to the electronic structure of the atoms.
- What is the correlation between atomic size and ionization energy?
  - Account for the fact that there is a decrease in first ionization energy from Be to B, and Mg to Al.
  - Suggest the reason for the decrease in first ionization energy from N to O, and P to S.
  - Explain why the substantial decrease in first ionization energy

observed between Na and K, and Mg and Ca, is not observed between A and Ga.

- (e) What is the significance of the large increase in the third ionization energy of Ca and the fifth ionization energy of Si?
  - (f) Why is the first ionization energy of the transition elements reasonably constant?
4. (a) What is electronegativity, and how is it related to the type of bond formed?  
(b) What are Fajans' rules?  
(c) Predict the type of bonds formed in HCl, CsCl, NH<sub>3</sub>, CS<sub>2</sub> and GeBr<sub>4</sub>.
  5. (a) List the different scales of electronegativity and briefly describe the theoretical basis behind each.  
(b) Give four examples to show how electronegativity values may be used to predict the type of bond formed in a compound.
  6. Use a modified Born-Haber cycle suitable for the estimation of electrode potentials to explain:  
(a) Why Li is as strong a reducing agent as Cs  
(b) Why Ag is a noble metal and K a highly reactive metal.
  7. (a) What are the standard electrode potentials, and how are they related to the electrochemical series?  
(b) Explain the recovery of copper from solution using scrap iron.  
(c) How is it possible to preferentially deposit metals electrolytically, e.g. Cu, Ni, and Zn from a solution containing all three?  
(d) Why is it possible to obtain zinc by electrolysis of an aqueous solution even though the electrode potentials would suggest that the water should decompose first?
  8. (a) Explain why Cu<sup>+</sup> disproportionates in solution.  
(b) Explain why the standard reduction potentials for Cu<sup>2+</sup> → Cu<sup>+</sup> and Cu<sup>+</sup> → Cu are +0.15 and +0.50 volt, respectively, yet that for Cu<sup>2+</sup> → Cu is + 0.34 volt.
  9. Name the eight most abundant elements in the earth's crust and place them in the correct order.
  10. Describe the following named metallurgical processes: (a) Bessemer, (b) BOP, (c) Kroll, (d) Van Arkel, (e) Hall-Hérout, (f) Parkes.
  11. Which elements occur in the native state?
  12. List five ores which are smelted, and give equations to show what occurs during smelting.
  13. Describe the extraction of three different elements using carbon as the reducing agent.
  14. Draw an Ellingham diagram for metal oxides and explain what information can be obtained from it. In addition explain why most of

the lines slope upwards from left to right, why the lines change in slope, and what happens when a line crosses the  $\Delta G = 0$  axis.

15. Use the Ellingham diagram for oxides to find:
  - (a) if Al will reduce chromium oxide
  - (b) at what temperature C will reduce magnesium oxide, and
  - (c) at what temperature mercuric oxide will decompose into its elements.
16. Explain in detail the processes involved in the production of pig iron and steel.
17. Describe the extraction of two metals and two non-metals by electrolysis.
18. Describe the extraction of magnesium and bromine from sea water.

## DOUBLE SALTS AND COORDINATION COMPOUNDS

Addition compounds are formed when stoichiometric amounts of two or more stable compounds join together. For example:

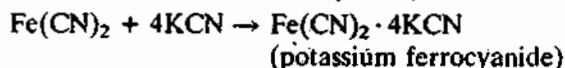
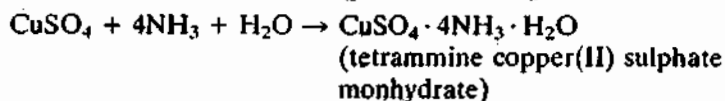
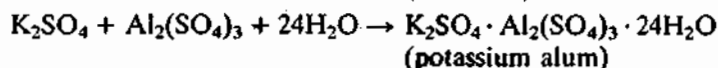
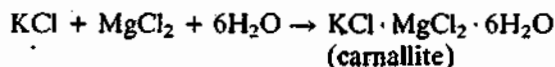

Addition compounds are of two types:

1. Those which lose their identity in solution (double salts)
2. Those which retain their identity in solution (complexes)

When crystals of carnallite are dissolved in water, the solution shows the properties of  $\text{K}^+$ ,  $\text{Mg}^{2+}$  and  $\text{Cl}^-$  ions. In a similar way, a solution of potassium alum shows the properties of  $\text{L}^+$ ,  $\text{Al}^{3+}$  and  $\text{SO}_4^{2-}$  ions. These are both examples of double salts which exist only in the crystalline state.

When the other two examples of coordination compounds dissolve they do not form simple ions –  $\text{Cu}^{2+}$ , or  $\text{Fe}^{2+}$  and  $\text{CN}^-$  – but instead their complex ions remain intact. Thus the cuproammonium ion  $[\text{Cu}(\text{H}_2\text{O})_2(\text{NH}_3)_4]^{2+}$  and the ferrocyanide ion  $[\text{Fe}(\text{CN})_6]^{4-}$  exist as distinct entities both in the solid and in solution. Complex ions are shown by the use of square brackets. Compounds containing these ions are called coordination compounds. *The chemistry of metal ions in solution is essentially the chemistry of their complexes. Transition metal ions, in particular, form many stable complexes.* In solution 'free' metal ions are coordinated either to water or to other ligands. Thus  $\text{Cu}^{2+}$  exists as the pale blue complex ion  $[\text{Cu}(\text{H}_2\text{O})_6]^{2+}$  in aqueous solution (and also in hydrated

crystalline salts). If aqueous ammonia is added to this solution, the familiar deep blue cuproammonium ion is formed:

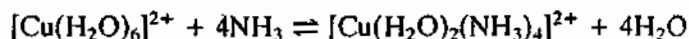

Note that this reaction is a substitution reaction, and the  $\text{NH}_3$  replaces water in the complex ion.

### WERNER'S WORK

Werner's coordination theory in 1893 was the first attempt to explain the bonding in coordination complexes. It must be remembered that this imaginative theory was put forward before the electron had been discovered by J.J. Thompson in 1896, and before the electronic theory of valency. This theory and his painstaking work over the next 20 years won Alfred Werner the Nobel Prize for Chemistry in 1913.

Complexes must have been a complete mystery without any knowledge of bonding or structure. For example, why does a stable salt like  $\text{CoCl}_3$  react with a varying number of stable molecules of a compound such as  $\text{NH}_3$  to give several new compounds:  $\text{CoCl}_3 \cdot 6\text{NH}_3$ ,  $\text{CoCl}_3 \cdot 5\text{NH}_3$  and  $\text{CoCl}_3 \cdot 4\text{NH}_3$ ? What are their structures? At that time X-ray diffraction, which is the most powerful method of determining the structures of crystals, had yet to be discovered. Werner did not have at his disposal any of the modern instrumental techniques, and all his studies were made using simple reaction chemistry. *Werner was able to explain the nature of bonding in complexes, and he concluded that in complexes the metal shows two different sorts of valency:*

1. *Primary valencies.* These are non-directional. The modern explanation would be as follows. The complex commonly exists as a positive ion. The primary valency is the number of charges on the complex ion. In compounds, this charge is matched by the same number of charges from negative ions. Primary valency applies equally well to simple salts and to complexes. Thus in  $\text{CoCl}_2$  ( $\text{Co}^{2+} + 2\text{Cl}^-$ ) there are two primary valencies, i.e. two ionic bonds. The complex  $[\text{Co}(\text{NH}_3)_6]\text{Cl}_3$  actually exists as  $[\text{Co}(\text{NH}_3)_6]^{3+}$  and  $3\text{Cl}^-$ . Thus the primary valency is 3, as there are three ionic bonds.
2. *Secondary valencies.* These are directional. In modern terms the number of secondary valencies equals the number of ligand atoms coordinated to the metal. This is now called the coordination number. Ligands are commonly negative ions such as  $\text{Cl}^-$ , or neutral molecules such as  $\text{NH}_3$ . Less commonly, ligands may be positive ions such as  $\text{NO}^+$ . Each metal has a characteristic number of secondary valencies. Thus in  $[\text{Co}(\text{NH}_3)_6]\text{Cl}_3$  the three  $\text{Cl}^-$  are held by primary valencies. The six  $\text{NH}_3$  groups are held by secondary valencies.

Secondary valencies are directional, and so a complex ion has a particular shape, e.g. the complex ion  $[\text{Co}(\text{NH}_3)_6]^{3+}$  is octahedral. Werner deduced the shapes of many complexes. He did this by preparing as many

different isomeric complexes of a system as was possible. He noted the number of isomers formed and related this number to the number of isomers predicted for different geometric shapes. The most common coordination number in transition metal complexes is 6, and the shape is usually octahedral. The coordination number 4 is also common, and this gives rise to either tetrahedral or square planar complexes.

Werner treated cold solutions of a series of coordination complexes with an excess of silver nitrate, and weighed the silver chloride precipitated. The stoichiometries of complex-AgCl formed were as follows:

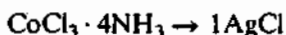

Werner deduced that in  $\text{CoCl}_3 \cdot 6\text{NH}_3$  the three chlorines acted as primary valencies, and the six ammonias as secondary valencies. In modern terms the complex is written  $[\text{Co}(\text{NH}_3)_6]\text{Cl}_3$ . The three  $\text{Cl}^-$  are ionic and hence are precipitated as AgCl by  $\text{AgNO}_3$ . The six  $\text{NH}_3$  ligands form coordinate bonds to  $\text{Co}^{3+}$ , forming a complex ion  $[\text{Co}(\text{NH}_3)_6]^{3+}$  (Figure 7.1a).

Werner deduced that loss of one  $\text{NH}_3$  from  $\text{CoCl}_3 \cdot 6\text{NH}_3$  should give  $\text{CoCl}_3 \cdot 5\text{NH}_3$ , and at the same time one Cl changed from being a primary valency to a secondary valency. Thus this complex had two primary valencies and six secondary valencies. In modern terms the complex  $[\text{Co}(\text{NH}_3)_5\text{Cl}]\text{Cl}_2$  ionizes to give  $[\text{Co}(\text{NH}_3)_5\text{Cl}]^{2+}$  and two  $\text{Cl}^-$  ions. Thus only two of the three chlorine atoms are ionic and thus only two are precipitated as AgCl with  $\text{AgNO}_3$ . Five  $\text{NH}_3$  and one Cl form coordinate bonds to  $\text{Co}^{3+}$ , forming a complex ion (Figure 7.1b).

Similarly in  $\text{CoCl}_3 \cdot 4\text{NH}_3$  Werner deduced that one Cl formed a primary valency, and that there were six secondary valencies (two Cl and four  $\text{NH}_3$ ). In modern terms the complex  $[\text{Co}(\text{NH}_3)_4\text{Cl}_2]\text{Cl}$  ionizes to give  $[\text{Co}(\text{NH}_3)_4\text{Cl}_2]^+$  and  $\text{Cl}^-$  and so only one  $\text{Cl}^-$  can be precipitated as AgCl. The coordination number of  $\text{Co}^{3+}$  is 6; in this case four  $\text{NH}_3$  and two  $\text{Cl}^-$  form coordinate bonds to  $\text{Co}^{3+}$ . The old and modern ways of writing the formulae of these complexes are shown in Table 7.1.

Thus Werner established that the number of secondary valencies (that is the coordination number) was 6 in these complexes. He then attempted to

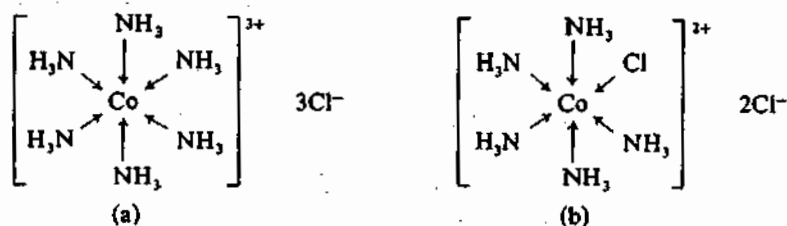

Figure 7.1 Structures of (a)  $[\text{Co}(\text{NH}_3)_6]\text{Cl}_3$  and (b)  $[\text{Co}(\text{NH}_3)_5\text{Cl}]\text{Cl}_2$ .

**Table 7.1** Formulae of some cobalt complexes

Old	New
$\text{CoCl}_3 \cdot 6\text{NH}_3$	$[\text{Co}(\text{NH}_3)_6]^{3+} \quad 3\text{Cl}^-$
$\text{CoCl}_3 \cdot 5\text{NH}_3$	$[\text{Co}(\text{NH}_3)_5\text{Cl}]^{2+} \quad 2\text{Cl}^-$
$\text{CoCl}_3 \cdot 4\text{NH}_3$	$[\text{Co}(\text{NH}_3)_4\text{Cl}_2]^+ \quad \text{Cl}^-$

find the shapes of the complexes. The possible arrangements of six groups round one atom are a planar hexagon, a trigonal prism, and an octahedron (Figure 7.2). Werner then compared the number of isomeric forms he had obtained with the theoretical number for each of the possible shapes (Table 7.2).

**Table 7.2** Number of isomers predicted and actually found

Complex	Observed	Predicted		
		Octahedral	Planar hexagon	Trigonal prism
$[\text{MX}_6]$	1	1	1	1
$[\text{MX}_5\text{Y}]$	1	1	1	1
$[\text{MX}_4\text{Y}_2]$	2	2	3	3
$[\text{MX}_3\text{Y}_3]$	2	2	3	3

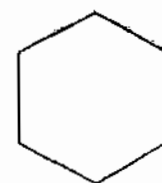

Planar hexagon

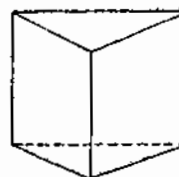

Trigonal prism

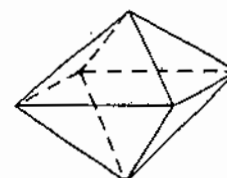

Octahedron

**Figure 7.2** Possible geometrical shapes for six-coordination.

These results strongly suggested that these complexes have an octahedral shape. This proof was not absolute proof, as it was just possible that the correct experimental conditions had not been found for preparing all the isomers. More recently the X-ray structures have been determined, and these establish that the shape is octahedral (Figure 7.3).

More recently, with a bidentate ligand such as ethylenediamine (1,2-diaminoethane), two optically active isomers have been found (Figure 7.4).

In a similar way, Werner studied a range of complexes which included  $[\text{Pt}^{\text{II}}(\text{NH}_3)_2\text{Cl}_2]$  and  $[\text{Pd}^{\text{II}}(\text{NH}_3)_2\text{Cl}_2]$ . The coordination number is 4, and the shape could be either tetrahedral or square planar. Werner was able to prepare two different isomers for these complexes. A tetrahedral complex can only exist in one form, but a square planar complex can exist in two isomeric forms. This proved these complexes are square planar rather than tetrahedral (Figure 7.5).

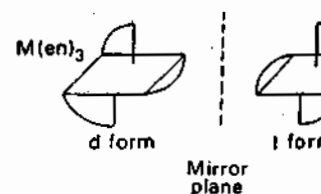
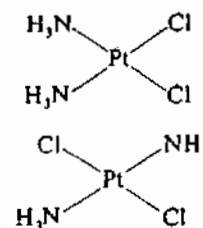

**Figure 7.4** Optical isomerism octahedral complexes.

**MORE RECENT METHODS OF STUDYING COMPLEXES**

The electrical conductivity of a solution of an ionic material depends on:

1. The concentration of solute.
2. The number of charges on the species which are formed on dissolution.



**Figure 7.5** Isomerism in square planar complexes.

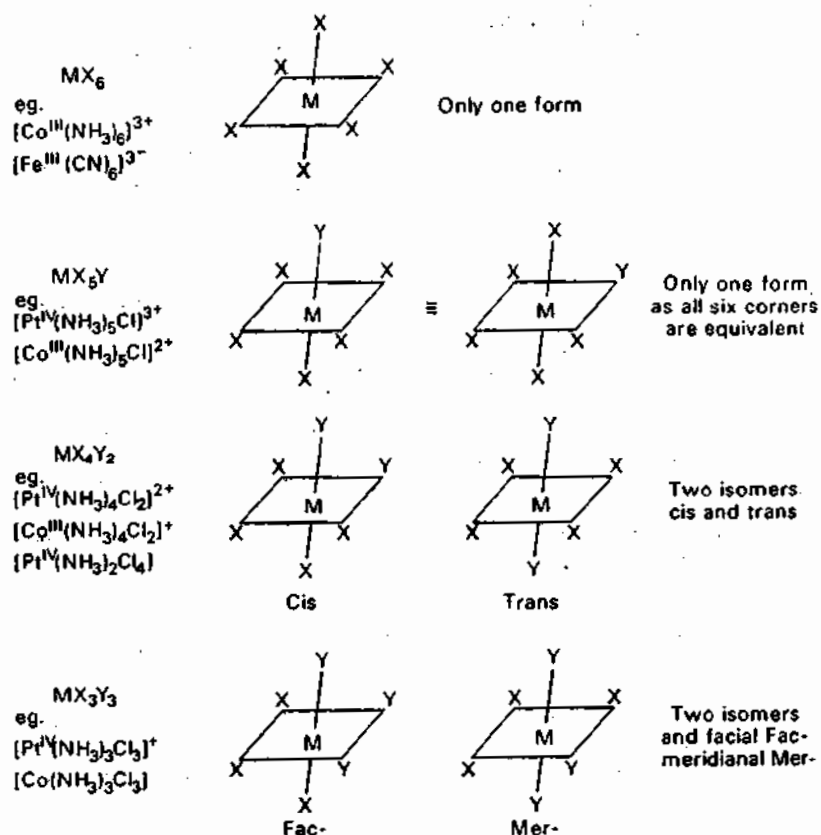

Figure 7.3 Isomers in octahedral complexes.

Molar conductivities relate to a 1 M solution and thus the concentration factor is removed. The total number of charges on the species formed when the complex dissolves can be deduced by comparison of its molar conductivity with that of known simple ionic materials (Table 7.3). These conductivities suggest the same structures for the cobalt/ammonia/chlorine

Table 7.3 Conductivities of salts and complexes (Molar conductivities measured at 0.001 M concentration)

			$ohm^{-1} cm^2 mol^{-1}$
LiCl	$\rightarrow Li^+ Cl^-$	(total of 2 charges)	112.0
CaCl <sub>2</sub>	$\rightarrow Ca^{2+} 2Cl^-$	(total of 4 charges)	260.8
CoCl <sub>3</sub> · 5NH <sub>3</sub>			261.3
CoBr <sub>3</sub> · 5NH <sub>3</sub>			257.6
LaCl <sub>3</sub>	$\rightarrow La^{3+} 3Cl^-$	(total of 6 charges)	393.5
CoCl <sub>3</sub> · 6NH <sub>3</sub>			431.6
CoBr <sub>3</sub> · 6NH <sub>3</sub>			426.9

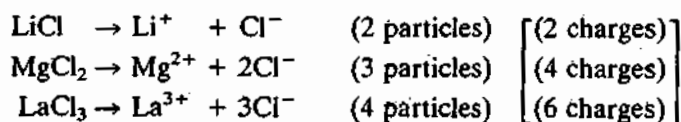

Table 7.4 Number of charges related to modern and Werner structures

	Charges	Primary valency ionizable chlorines	Secondary valency
$[\text{Co}(\text{NH}_3)_6]^{3+}$	$3\text{Cl}^-$	6	3
$[\text{Co}(\text{NH}_3)_5\text{Cl}]^{2+}$	$2\text{Cl}^-$	4	2
$[\text{Co}(\text{NH}_3)_4\text{Cl}_2]^+$	$\text{Cl}^-$	2	1
			$6\text{NH}_3 = 6$
			$5\text{NH}_3 + 1\text{Cl}^- = 6$
			$4\text{NH}_3 + 2\text{Cl}^- = 6$

complexes mentioned earlier, as do the results from Werner's AgCl experiments, shown in Table 7.4.

The freezing point of a liquid is lowered when a chemical substance is dissolved in it. Cryoscopic measurements involve measuring how much the freezing point is lowered. The depression of freezing point obtained depends on the number of particles present. Cryoscopic measurements can be used to find if a molecule dissociates, and how many ions are formed. If a molecule dissociates into two ions it will give twice the expected depression for a single particle. If three ions are formed this will give three times the expected depression. Thus:



The number of particles formed from a complex molecule determines the size of the depression of freezing point. Note that the number of particles formed may be different from the total number of charges which can be obtained from conductivity measurements. The two types of information can be used together to establish the structure (Table 7.5).

The magnetic moment can be measured (see Chapter 18 - Magnetic properties). This provides information about the number of unpaired electron spins present in a complex. From this it is possible to decide how the electrons are arranged and which orbitals are occupied. Sometimes the structure of the complex can be deduced from this. For example, the compound  $\text{Ni}^{II}(\text{NH}_3)_4(\text{NO}_3)_2 \cdot 2\text{H}_2\text{O}$  might contain four ammonia mole-

Table 7.5 Establishing the structure of complexes

Formula	Cryoscopic measurement	Molar conductivity	Structure
$\text{CoCl}_3 \cdot 6\text{NH}_3$	4 particles	6 charges	$[\text{Co}(\text{NH}_3)_6]^{3+} \quad 3\text{Cl}^-$
$\text{CoCl}_3 \cdot 5\text{NH}_3$	3 particles	4 charges	$[\text{Co}(\text{NH}_3)_5\text{Cl}]^{2+} \quad 2\text{Cl}^-$
$\text{CoCl}_3 \cdot 4\text{NH}_3$	2 particles	2 charges	$[\text{Co}(\text{NH}_3)_4\text{Cl}_2]^+ \quad \text{Cl}^-$
$\text{CoCl}_3 \cdot 3\text{NH}_3$	1 particle	0 charge	$[\text{Co}(\text{NH}_3)_3\text{Cl}_3]$
$\text{Co}(\text{NO}_2)_3 \cdot \text{KNO}_2 \cdot 2\text{NH}_3$	2 particles	2 charges	$\text{K}^+ \quad [\text{Co}(\text{NH}_3)_2(\text{NO}_2)_4]^-$
$\text{Co}(\text{NO}_2)_3 \cdot 2\text{KNO}_2 \cdot \text{NH}_3$	3 particles	4 charges	$2\text{K}^+ \quad [\text{Co}(\text{NH}_3)(\text{NO}_2)_5]^{2-}$
$\text{Co}(\text{NO}_2)_3 \cdot 3\text{KNO}_2$	4 particles	6 charges	$3\text{K}^+ \quad [\text{Co}(\text{NO}_2)_6]^{3-}$

cules coordinated to Ni in a square planar  $[\text{Ni}(\text{NH}_3)_4]^{2+}$  ion and two molecules of water of crystallization and have no unpaired electrons. Alternatively the water might be coordinated to the metal, giving an octahedral  $[\text{Ni}(\text{H}_2\text{O})_2(\text{NH}_3)_4]^{2+}$  complex with two unpaired electrons. Both these complex ions exist and their structures can be deduced from magnetic measurements.

Dipole moments may also yield structural information but only for non-ionic complexes. For example, the complex  $[\text{Pt}(\text{NH}_3)_2\text{Cl}_2]$  is square planar, and can exist as *cis* or *trans* forms. The dipole moments from the various metal-ligand bonds cancel out in the *trans* configuration. However, a finite dipole moment is given by the *cis* arrangement.

Electronic spectra (UV and visible) also provide valuable information on the energy of the orbitals, and on the shape of the complex. By this means it is possible to distinguish between tetrahedral and octahedral complexes, and whether the shape is distorted or regular.

The most powerful method, however, is the X-ray determination of the crystal structure. This provides details of the exact shape and the bond lengths and angles of the atoms in the structure.

### EFFECTIVE ATOMIC NUMBERS

The number of secondary valencies in the Werner theory is now called the coordination number of the central metal in the complex. This is the number of ligand atoms bonded to the central metal ion. Each ligand donates an electron pair to the metal ion, thus forming a coordinate bond. Transition metals form coordination compounds very readily because they have vacant *d* orbitals which can accommodate these electron pairs. The electronic arrangement of the noble gases is known to be very stable. Sidgwick, with his effective atomic number rule, suggested that electron pairs from ligands were added until the central metal was surrounded by the same number of electrons as the next noble gas. Consider potassium hexacyanoferrate(II)  $\text{K}_4[\text{Fe}(\text{CN})_6]$  (formerly called potassium ferrocyanide). An iron atom has 26 electrons, and so the central metal ion  $\text{Fe}^{2+}$  has 24 electrons. The next noble gas Kr has 36 electrons. Thus the addition of six electron pairs from six  $\text{CN}^-$  ligands adds 12 electrons, thus raising the effective atomic number (EAN) of  $\text{Fe}^{2+}$  in the complex  $[\text{Fe}(\text{CN})_6]^{4-}$  to 36.

$$[24 + (6 \times 2) = 36]$$

Further examples are given in Table 7.6.

The EAN rule correctly predicts the number of ligands in many complexes. There are, however, a significant number of exceptions where the EAN is not quite that of a noble gas. If the original metal ion has an odd number of electrons, for example, the adding of electron pairs cannot result in a noble gas structure. The tendency to attain a noble gas configuration is a significant factor but not a necessary condition for complex formation. It is also necessary to produce a symmetrical structure (tetra-

Table 7.6 Effective atomic numbers of some metals in complexes

Atom	Atomic number	Complex	Electrons lost in ion formation	Electrons gained by coordination	EAN
Cr	24	[Cr(CO) <sub>6</sub> ]	0	12	36
Fe	26	[Fe(CN) <sub>6</sub> ] <sup>4-</sup>	2	12	36
Fe	26	[Fe(CO) <sub>5</sub> ]	0	10	36
Co	27	[Co(NH <sub>3</sub> ) <sub>6</sub> ] <sup>3+</sup>	3	12	36
Ni	28	[Ni(CO) <sub>4</sub> ]	0	8	36
Cu	29	[Cu(CN) <sub>4</sub> ] <sup>3-</sup>	1	8	36
Pd	46	[Pd(NH <sub>3</sub> ) <sub>6</sub> ] <sup>4+</sup>	4	12	54
Pt	78	[PtCl <sub>6</sub> ] <sup>2-</sup>	4	12	86
					(Kr)
					(Xe)
					(Rn)
Fe	26	[Fe(CN) <sub>6</sub> ] <sup>3-</sup>	3	12	35
Ni	28	[Ni(NH <sub>3</sub> ) <sub>6</sub> ] <sup>2+</sup>	2	12	38
Pd	46	[PdCl <sub>4</sub> ] <sup>2-</sup>	2	8	52
Pt	78	[Pt(NH <sub>3</sub> ) <sub>4</sub> ] <sup>2+</sup>	2	8	84

hedra, square planar, octahedral) irrespective of the number of electrons involved.

### SHAPES OF *d* ORBITALS

Since *d* orbitals are often used in coordination complexes it is important to study their shapes and distribution in space. The five *d* orbitals are not identical and the orbitals may be divided into two sets. The three *t<sub>2g</sub>* orbitals have identical shape and point between the axes, *x*, *y* and *z*. The

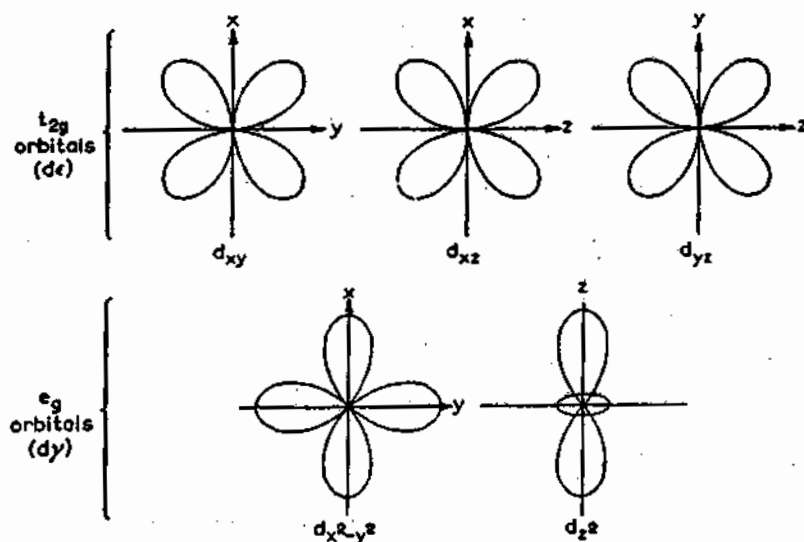
Figure 7.6 Shapes of *d* orbitals.

two  $e_g$  orbitals have different shapes and point along the axes (Figure 7.6). Alternative names for  $t_{2g}$  and  $e_g$  are  $d_{xy}$  and  $d_{yz}$  respectively.

### BONDING IN TRANSITION METAL COMPLEXES

There are three theories of metal to ligand bonding in complexes, all dating back to the 1930s.

#### Valence bond theory

This theory was developed by Pauling. Coordination compounds contain complex ions, in which ligands form coordinate bonds to the metal. Thus the ligand must have a lone pair of electrons, and the metal must have an empty orbital of suitable energy available for bonding. The theory considers which atomic orbitals on the metal are used for bonding. From this the shape and stability of the complex are predicted. The theory has two main limitations. Most transition metal complexes are coloured, but the theory provides no explanation for their electronic spectra. Further, the theory does not explain why the magnetic properties vary with temperature. For these reasons it has largely been superseded by the crystal field theory. However, it is of interest for study as it shows the continuity of the development of modern ideas from Werner's theory.

#### Crystal field theory

This theory was proposed by Bethe and van Vleck. The attraction between the central metal and ligands in the complex is considered to be purely electrostatic. Thus bonding in the complex may be ion-ion attraction (between positive and negative ions such as  $\text{Co}^{3+}$  and  $\text{Cl}^-$ ). Alternatively, ion-dipole attractions may give rise to bonding (if the ligand is a neutral molecule such as  $\text{NH}_3$  or  $\text{CO}$ ).  $\text{NH}_3$  has a dipole moment with a  $\delta^-$  charge on N and  $\delta^+$  charges on H. Thus in  $[\text{Co}(\text{NH}_3)_6]^{3+}$  the  $\delta^-$  charge on the N atom of each  $\text{NH}_3$  points towards the  $\text{Co}^{3+}$ . This theory is simple. It has been remarkably successful in explaining the electronic spectra and magnetism of transition metal complexes, particularly when allowance is made for the possibility of some covalent interaction between the orbitals on the metal and ligand. When some allowance is made for covalency, the theory is often renamed as the ligand field theory. Three types of interaction are possible:  $\sigma$  overlap of orbitals,  $\pi$  overlap of orbitals, or  $d\pi-p\pi$  bonding (back bonding) due to  $\pi$  overlap of full  $d$  orbitals on the metal with empty  $p$  orbitals on the ligands.

#### Molecular orbital theory

Both covalent and ionic contributions are fully allowed for in this theory.

Though this theory is probably the most important approach to chemical bonding, it has not displaced the other theories. This is because the quantitative calculations involved are difficult and lengthy, involving the use

of extensive computer time. Much of the qualitative description can be obtained by other approaches using symmetry and group theory.

### VALENCE BOND THEORY

The formation of a complex may be considered as a series of hypothetical steps. First the appropriate metal ion is taken, e.g.  $\text{Co}^{3+}$ . A Co atom has the outer electronic structure  $3d^74s^2$ . Thus a  $\text{Co}^{3+}$  ion will have the structure  $3d^6$ , and the electrons will be arranged:

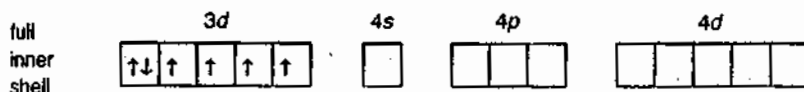

If this ion forms a complex with six ligands, then six empty atomic orbitals are required on the metal ion to receive the coordinated lone pairs of electrons. The orbitals used are the  $4s$ , three  $4p$  and two  $4d$ . These are hybridized to give a set of six equivalent  $sp^3d^2$  hybrid orbitals. A ligand orbital containing a lone pair of electrons forms a coordinate bond by overlapping with an empty hybrid orbital on the metal ion. In this way a  $\sigma$  bond is formed with each ligand. The  $d$  orbitals used are the  $4d_{x^2-y^2}$  and  $4d_{z^2}$ . In the diagrams below, electron pairs from the ligands are shown as  $\uparrow\downarrow$ .

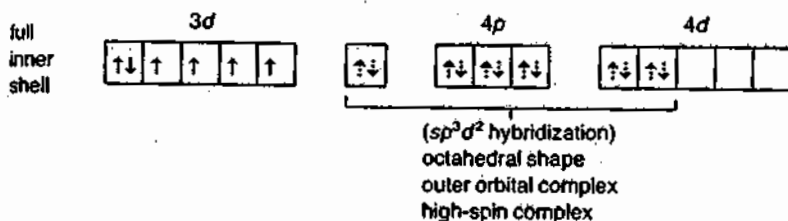

Since the outer  $4d$  orbitals are used for bonding this is called an *outer orbital complex*. The energy of these orbitals is quite high, so that the complex will be reactive or labile. The magnetic moment depends on the number of unpaired electrons. The  $3d$  level contains the maximum number of unpaired electrons for a  $d^6$  arrangement, so this is sometimes called a *high-spin* or a *spin-free complex*. An alternative octahedral arrangement is possible when the electrons on the metal ion are rearranged as shown below. As before, lone pairs from the ligands are shown as  $\uparrow\downarrow$ .

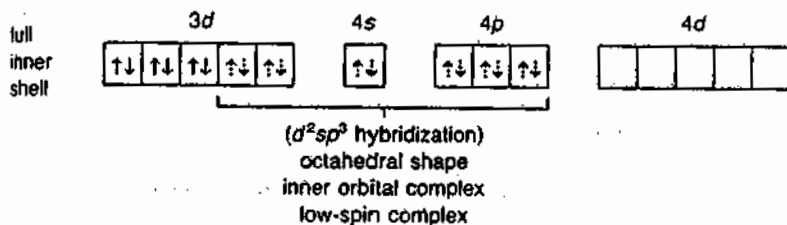

Since low energy inner  $d$  orbitals are used, this is called an *inner orbital complex*. Such complexes are more stable than the outer orbital complexes. The unpaired electrons in the metal ion have been forced to pair up, and so this is now a low-spin complex. In this particular case all the electrons are paired, so the complex will be diamagnetic.

The metal ion could also form four-coordinate complexes, and two different arrangements are possible. *It must be remembered that hybrid orbitals do not actually exist.* Hybridization is a mathematical manipulation of the wave equations for the atomic orbitals involved.

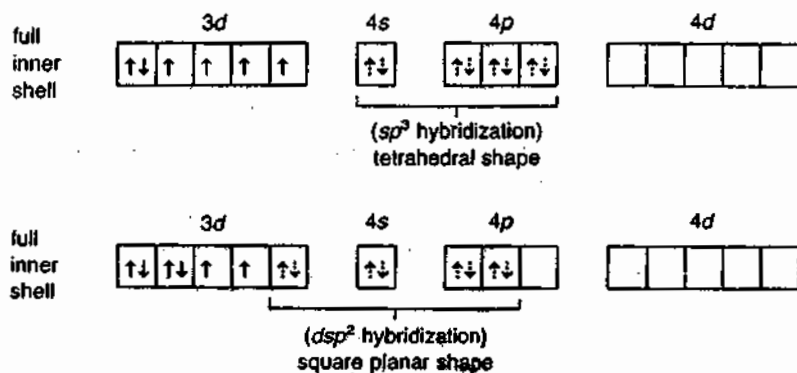

The theory does not explain the colour and spectra of complexes. The theory shows the number of unpaired electrons. From this the magnetic moment can be calculated (see Chapter 18). However, it does not explain why the magnetic moment varies with temperature.

### CRYSTAL FIELD THEORY

The crystal field theory is now much more widely accepted than the valence bond theory. It assumes that the attraction between the central metal and the ligands in a complex is purely electrostatic. The transition metal which forms the central atom in the complex is regarded as a positive ion of charge equal to the oxidation state. This is surrounded by negative ligands or neutral molecules which have a lone pair of electrons. If the ligand is a neutral molecule such as  $\text{NH}_3$ , the negative end of the dipole in the molecule is directed towards the metal ion. The electrons on the central metal are under repulsive forces from those on the ligands. Thus the electrons occupy the  $d$  orbitals furthest away from the direction of approach of ligands. In the crystal field theory the following assumptions are made.

1. Ligands are treated as point charges.
2. There is no interaction between metal orbitals and ligand orbitals.
3. The  $d$  orbitals on the metal all have the same energy (that is degenerate) in the free atom. However, when a complex is formed the ligands destroy the degeneracy of these orbitals, i.e. the orbitals now have

different energies. In an isolated gaseous metal ion, the five  $d$  orbitals do all have the same energy, and are termed degenerate. If a spherically symmetrical field of negative charges surrounds the metal ion, the  $d$  orbitals remain degenerate. However, the energy of the orbitals is raised because of repulsion between the field and the electrons on the metal. In most transition metal complexes, either six or four ligands surround the metal, giving octahedral or tetrahedral structures. In both of these cases the field produced by the ligands is not spherically symmetrical. Thus the  $d$  orbitals are not all affected equally by the ligand field.

### Octahedral complexes

In an octahedral complex, the metal is at the centre of the octahedron, and the ligands are at the six corners. The directions  $x$ ,  $y$  and  $z$  point to three adjacent corners of the octahedron as shown in Figure 7.7.

The lobes of the  $e_g$  orbitals ( $d_{x^2-y^2}$  and  $d_{z^2}$ ) point along the axes  $x$ ,  $y$  and  $z$ . The lobes of the  $t_{2g}$  orbitals ( $d_{xy}$ ,  $d_{xz}$  and  $d_{yz}$ ) point in between the axes. It follows that the approach of six ligands along the  $x$ ,  $y$ ,  $z$ ,  $-x$ ,  $-y$  and  $-z$  directions will increase the energy of the  $d_{x^2-y^2}$  and  $d_{z^2}$  orbitals (which point along the axes) much more than it increases the energy of the  $d_{xy}$ ,  $d_{xz}$  and  $d_{yz}$  orbitals (which point between the axes). Thus under the influence of an octahedral ligand field the  $d$  orbitals split into two groups of different energies (Figure 7.8).

Rather than referring to the energy level of an isolated metal atom, the weighted mean of these two sets of perturbed orbitals is taken as the zero: this is sometimes called the Bari centre. The difference in energy between the two  $d$  levels is given either of the symbols  $\Delta_o$  or  $10 Dq$ . It follows that

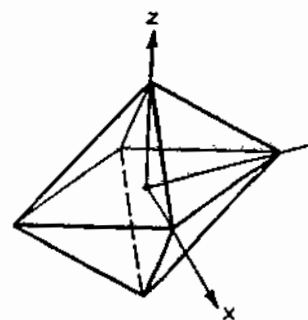

Figure 7.7 The directions in an octahedral complex.

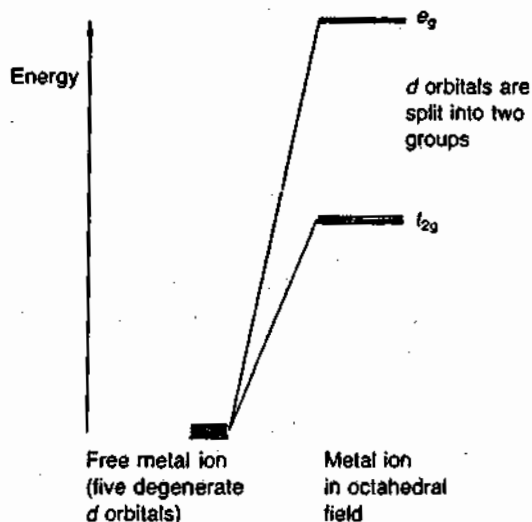

Figure 7.8 Crystal field splitting of energy levels in an octahedral field.

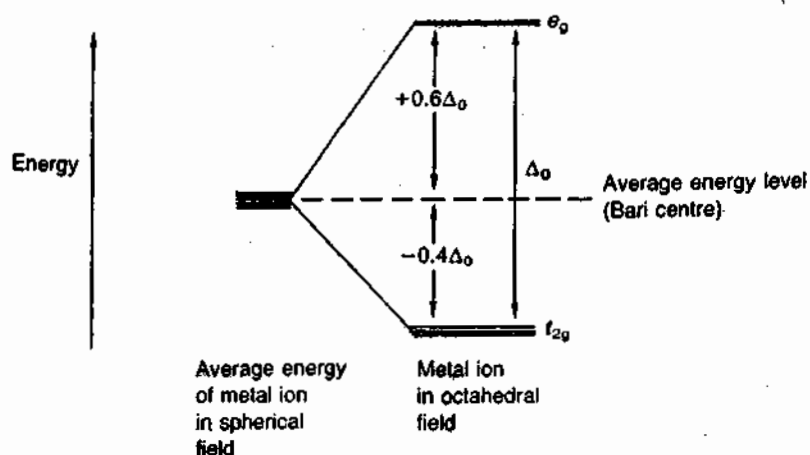

Figure 7.9 Diagram of the energy levels of  $d$  orbitals in an octahedral field.

the  $e_g$  orbitals are  $+0.6\Delta_o$  above the average level, and the  $t_{2g}$  orbitals are  $-0.4\Delta_o$  below the average (Figure 7.9).

The size of the energy gap  $\Delta_o$  between the  $t_{2g}$  and  $e_g$  levels can be measured easily by recording the UV-visible spectrum of the complex. Consider a complex like  $[\text{Ti}(\text{H}_2\text{O})_6]^{3+}$ . The  $\text{Ti}^{3+}$  ion has one  $d$  electron. In the complex this will occupy the orbital with the lowest energy, that is one of the  $t_{2g}$  orbitals (Figure 7.10a). The complex absorbs light of the correct wavelength (energy) to promote the electron from the  $t_{2g}$  level to the  $e_g$  level (Figure 7.10b).

The electronic spectrum for  $[\text{Ti}(\text{H}_2\text{O})_6]^{3+}$  is given in Figure 7.11. The steep part of the curve from 27 000 to 30 000  $\text{cm}^{-1}$  (in the UV region) is due to charge transfer. The  $d-d$  transition is the single broad peak with a maximum at 20 300  $\text{cm}^{-1}$ . Since  $1 \text{ kJ mol}^{-1} = 83.7 \text{ cm}^{-1}$ , the value of  $\Delta_o$

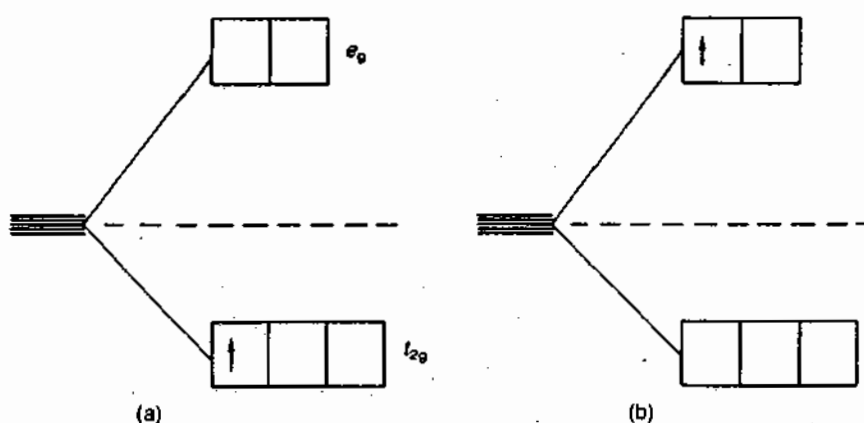

Figure 7.10  $d^1$  configuration: (a) ground state, (b) excited state.



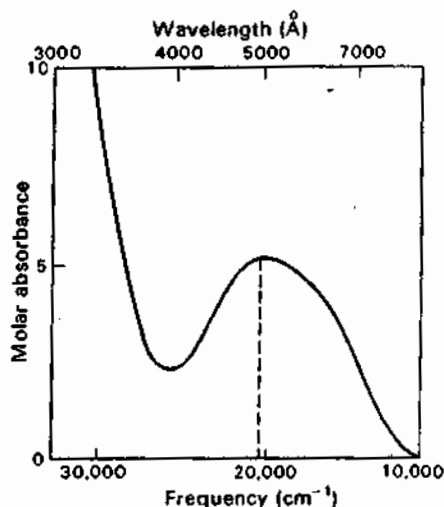

Figure 7.11 Ultraviolet and visible absorption spectrum of  $[\text{Ti}(\text{H}_2\text{O})_6]^{3+}$ .

for  $[\text{Ti}(\text{H}_2\text{O})]^{3+}$  is  $20\,300/83.7 = 243 \text{ kJ mol}^{-1}$ . This is much the same as the energy of many normal single bonds (see Appendix F).

The above method is the most convenient way of measuring  $\Delta_o$  values. However,  $\Delta_o$  values can also be obtained from values of observed lattice energies and those calculated using the Born-Landé equation (see Chapter 3).

Solutions containing the hydrated  $\text{Ti}^{3+}$  ion are reddish violet coloured. This is because yellow and green light are absorbed to excite the electron. Thus the transmitted light is the complementary colour red-violet (Table 7.7).

Because of the crystal field splitting of  $d$  orbitals, the single  $d$  electron in  $[\text{Ti}(\text{H}_2\text{O})]^{3+}$  occupies an energy level  $2/5\Delta_o$  below the average energy of the  $d$  orbitals. As a result the complex is more stable. The crystal field stabilization energy (CFSE) is in this case  $2/5 \times 243 = 97 \text{ kJ mol}^{-1}$ .

The magnitude of  $\Delta_o$  depends on three factors:

Table 7.7 Colours absorbed and colours observed

Colour absorbed	Colour observed	Wavenumber observed ( $\text{cm}^{-1}$ )
yellow-green	red-violet	24 000–26 000
yellow	indigo	23 000–24 000
orange	blue	21 000–23 000
red	blue-green	20 000–21 000
purple	green	18 000–20 000
red-violet	yellow-green	17 300–18 000
indigo	yellow	16 400–17 300
blue	orange	15 300–16 400
blue-green	red	12 800–15 300

Table 7.8 Crystal field splittings by various ligands

Complex	Absorption peak	
	( $\text{cm}^{-1}$ )	( $\text{kJ mol}^{-1}$ )
$[\text{Cr}^{\text{III}}\text{Cl}_6]^{3-}$	13640	163
$[\text{Cr}^{\text{III}}(\text{H}_2\text{O})_6]^{3+}$	17830	213
$[\text{Cr}^{\text{III}}(\text{NH}_3)_6]^{3+}$	21680	259
$[\text{Cr}^{\text{III}}(\text{CN})_6]^{3-}$	26280	314

1. The nature of the ligands.
2. The charge on the metal ion.
3. Whether the metal is in the first, second or third row of transition elements.

Examination of the spectra of a series of complexes of the same metal with different ligands shows that the position of the absorption band (and hence the value of  $\Delta_o$ ) varies depending on the ligands which are attached (Table 7.8).

Ligands which cause only a small degree of crystal field splitting are termed weak field ligands. Ligands which cause a large splitting are called strong field ligands. Most  $\Delta$  values are in the range  $7000 \text{ cm}^{-1}$  to  $30000 \text{ cm}^{-1}$ . The common ligands can be arranged in ascending order of crystal field splitting  $\Delta$ . The order remains practically constant for different metals, and this series is called the spectrochemical series (see Further Reading Tsuchida, 1938; Jørgensen, 1962).

#### Spectrochemical series

##### weak field ligands

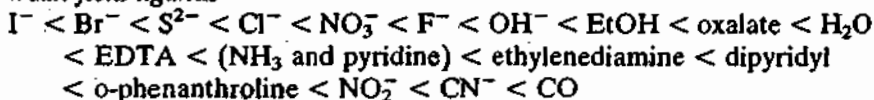

##### strong field ligands

The spectrochemical series is an experimentally determined series. It is difficult to explain the order as it incorporates both the effects of  $\sigma$  and  $\pi$  bonding. The halides are in the order expected from electrostatic effects. In other cases we must consider covalent bonding to explain the order. A pattern of increasing  $\sigma$  donation is followed:



The crystal field splitting produced by the strong field  $\text{CN}^-$  ligand is about double that for weak field ligands like the halide ions. This is attributed to  $\pi$  bonding in which the metal donates electrons from a filled  $t_{2g}$  orbital into a vacant orbital on the ligand. In a similar way, many unsaturated N donors and C donors may also act as  $\pi$  acceptors.

The magnitude of  $\Delta_o$  increases as the charge on the metal ion increases.

Table 7.9 Crystal field splittings for hexa-aqua complexes of  $M^{2+}$  and  $M^{3+}$ 

Oxidation state		Ti	V	Cr	Mn	Fe	Co	Ni	Cu
(+II)	Electronic configuration	$d^2$	$d^3$	$d^4$	$d^5$	$d^6$	$d^7$	$d^8$	$d^9$
	$\Delta_o$ in $\text{cm}^{-1}$	-	12 600	13 900	7 800	10 400	9 300	8 500	12 600
	$\Delta_o$ in $\text{kJ mol}^{-1}$	-	151	(166)	93	124	111	102	(151)
(+III)	Electronic configuration	$d^1$	$d^2$	$d^3$	$d^4$	$d^5$	$d^6$	$d^7$	$d^8$
	$\Delta_o$ in $\text{cm}^{-1}$	20 300	18 900	17 830	21 000	13 700	18 600	-	-
	$\Delta_o$ in $\text{kJ mol}^{-1}$	243	226	213	(251)	164	222	-	-

Values for  $d^4$  and  $d^9$  are approximate because of tetragonal distortion.

Table 7.10  $\Delta_o$  crystal field splittings in one group

	$\text{cm}^{-1}$	$\text{kJ mol}^{-1}$
$[\text{Co}(\text{NH}_3)_6]^{3+}$	24 800	296
$[\text{Rh}(\text{NH}_3)_6]^{3+}$	34 000	406
$[\text{Ir}(\text{NH}_3)_6]^{3+}$	41 000	490

For first row transition metal ions, the values of  $\Delta_o$  for  $M^{3+}$  complexes are roughly 50% larger than the values for  $M^{2+}$  complexes (Table 7.9).

The value of  $\Delta_o$  also increases by about 30% between adjacent members down a group of transition elements (Table 7.10). The crystal field stabilization energy in  $[\text{Ti}(\text{H}_2\text{O})_6]^{3+}$ , which has a  $d^1$  configuration, has previously been shown to be  $-0.4\Delta_o$ . In a similar way, complexes containing a metal ion with a  $d^2$  configuration will have a CFSE of  $2 \times -0.4\Delta_o = -0.8\Delta_o$  by singly filling two of the  $t_{2g}$  orbitals. (This is in agreement with Hund's rule that the arrangement with the maximum number of unpaired electrons is the most stable.) Complexes of  $d^3$  metal ions have a CFSE of  $3 \times -0.4\Delta_o = -1.2\Delta_o$ .

Complexes with a metal ion with a  $d^4$  configuration would be expected to have an electronic arrangement in accordance with Hund's rule (Figure 7.12a) with four unpaired electrons, and the CFSE will be  $(3 \times -0.4\Delta_o) + (0.6\Delta_o) = -0.6\Delta_o$ . An alternative arrangement of electrons which does not comply with Hund's rule is shown in Figure 7.12b. This arrangement has two unpaired electrons, and the CFSE is  $(4 \times -0.4\Delta_o) = -1.6\Delta_o$ . The CFSE is larger than in the previous case. However, the energy  $P$  used to pair the electrons must be allowed for, so the total stabilization energy is  $-1.6\Delta_o + P$ . These two arrangements differ in the number of unpaired electrons. The one with the most unpaired electrons is called 'high-spin' or 'spin-free', and the other one the 'low-spin' or 'spin-paired' arrangement. Both arrangements have been found to exist. Which arrangement occurs for any particular complex depends on whether the energy to promote an

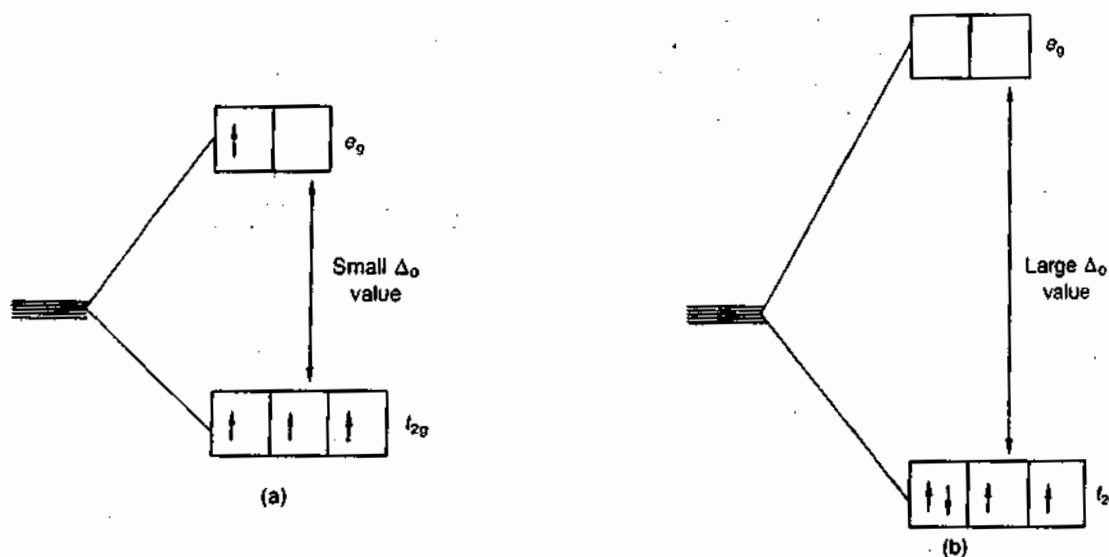

Figure 7.12 High- and low-spin complexes: (a)  $d^4$  high-spin arrangement (weak ligand field); (b)  $d^4$  low-spin arrangement (strong ligand field).

Table 7.11 CFSE and pairing energy for some complexes

Complex	Configuration	$\Delta_o$ ( $\text{cm}^{-1}$ )	$P$ ( $\text{cm}^{-1}$ )	Predicted	Found
$[\text{Fe}^{\text{II}}(\text{H}_2\text{O})_6]^{2+}$	$d^6$	10 400	17 600	high spin	high spin
$[\text{Fe}^{\text{II}}(\text{CN})_6]^{4-}$	$d^6$	32 850	17 600	low spin	low spin
$[\text{Co}^{\text{III}}\text{F}_6]^{3-}$	$d^7$	13 000	21 000	high spin	high spin
$[\text{Co}^{\text{III}}(\text{NH}_3)_6]^{3+}$	$d^7$	23 000	21 000	low spin	low spin

electron to the upper  $e_g$  level (that is the crystal field splitting  $\Delta_o$ ) is greater than the energy to pair electrons (that is  $P$ ) in the lower  $t_{2g}$  level. For given metal ion  $P$  is constant. Thus the amount of crystal field splitting is determined by the strength of the ligand field. A weak field ligand such as  $\text{Cl}^-$  will only cause a small splitting of energy levels  $\Delta_o$ . Thus it will be more favourable energetically for electrons to occupy the upper  $e_g$  level and have a high-spin complex, rather than to pair electrons. In a similar way, strong field ligands such as  $\text{CN}^-$  cause a large splitting  $\Delta_o$ . In this case it requires less energy to pair the electrons and form a low-spin complex.

Similar arguments apply to high- and low-spin complexes of metal ions with  $d^5$ ,  $d^6$  and  $d^7$  configurations. These are summarized in Table 7.12.

### EFFECTS OF CRYSTAL FIELD SPLITTING

In octahedral complexes, the filling of  $t_{2g}$  orbitals decreases the energy of the complex, that is makes it more stable by  $-0.4\Delta_o$  per electron. Filling

Table 7.12 CFSE and electronic arrangements in octahedral complexes

Number of $d$ electrons	Arrangement in weak ligand field				Arrangement in strong ligand field			
	$t_{2g}$	$e_g$	CFSE $\Delta_o$	Spin only magnetic moment $\mu_s(D)$	$t_{2g}$	$e_g$	CFSE $\Delta_o$	Spin only magnetic moment $\mu_s(D)$
$d^1$	$\uparrow \square \square$	$\square \square$	-0.4	1.73	$\uparrow \square \square$	$\square \square$	-0.4	1.73
$d^2$	$\uparrow \uparrow \square$	$\square \square$	-0.8	2.83	$\uparrow \uparrow \square$	$\square \square$	-0.8	2.83
$d^3$	$\uparrow \uparrow \uparrow$	$\square \square$	-1.2	3.87	$\uparrow \uparrow \uparrow$	$\square \square$	-1.2	3.87
$d^4$	$\uparrow \uparrow \uparrow$	$\uparrow \square$	-1.2 +0.6 = -0.6	4.90	$\uparrow \downarrow \uparrow \uparrow$	$\square \square$	-1.6	2.83
$d^5$	$\uparrow \uparrow \uparrow$	$\uparrow \uparrow$	-1.2 +1.2 = -0.0	5.92	$\uparrow \downarrow \uparrow \downarrow \uparrow$	$\square \square$	-2.0	1.73
$d^6$	$\uparrow \downarrow \uparrow \uparrow$	$\uparrow \uparrow$	-1.6 +1.2 = -0.4	4.90	$\uparrow \downarrow \uparrow \downarrow \uparrow$	$\square \square$	-2.4	0.00
$d^7$	$\uparrow \downarrow \uparrow \downarrow \uparrow$	$\uparrow \uparrow$	-2.0 +1.2 = -0.8	3.87	$\uparrow \downarrow \uparrow \downarrow \uparrow$	$\uparrow \square$	-2.4 +0.6 = -1.8	1.73
$d^8$	$\uparrow \downarrow \uparrow \downarrow \uparrow$	$\uparrow \uparrow$	-2.4 +1.2 = -1.2	2.83	$\uparrow \downarrow \uparrow \downarrow \uparrow$	$\uparrow \uparrow$	-2.4 +1.2 = -1.2	2.83
$d^9$	$\uparrow \downarrow \uparrow \downarrow \uparrow$	$\uparrow \uparrow$	-2.4 +1.8 = -0.6	1.73	$\uparrow \downarrow \uparrow \downarrow \uparrow$	$\uparrow \uparrow$	-2.4 +1.8 = -0.6	1.73
$d^{10}$	$\uparrow \downarrow \uparrow \downarrow \uparrow$	$\uparrow \downarrow \uparrow \downarrow$	-2.4 +2.4 = 0.0	0.00	$\uparrow \downarrow \uparrow \downarrow \uparrow$	$\uparrow \downarrow \uparrow \downarrow$	-2.4 +2.4 = 0.0	0.00

orbitals increases the energy by  $+0.6\Delta_o$  per electron. The total crystal field stabilization energy is given by

$$\text{CFSE}_{(\text{octahedral})} = -0.4n_{(t_{2g})} + 0.6n_{(e_g)}$$

where  $n_{(t_{2g})}$  and  $n_{(e_g)}$  are the number of electrons occupying the  $t_{2g}$  and  $e_g$  orbitals respectively. The CFSE is zero for ions with  $d^0$  and  $d^{10}$  configurations in both strong and weak ligand fields. The CFSE is also zero for  $d^5$  configurations in a weak field. All the other arrangements have some

Table 7.13 Measured and calculated lattice energies

Compound	Structure	Measured lattice energy (kJ mol <sup>-1</sup> )	Calculated lattice energy (kJ mol <sup>-1</sup> )	Difference (measured - calculated) (kJ mol <sup>-1</sup> )
NaCl	Sodium chloride	-764	-764	0
AgCl	Sodium chloride	-916	-784	-132
AgBr	Sodium chloride	-908	-759	-149
MgF <sub>2</sub>	Rutile	-2908	-2915	+7
MnF <sub>2</sub>	Rutile	-2770	-2746	-24
FeF <sub>2</sub>	Rutile	-2912	-2752	-160
NiF <sub>2</sub>	Rutile	-3046	-2917	-129
CuF <sub>2</sub>	Rutile	-3042	-2885	-157

CFSE, which increases the thermodynamic stability of the complexes. Thus many transition metal compounds have a higher measured lattice energy (obtained by calculations using the terms in the Born-Haber cycle) than is calculated using the Born-Landé, Born-Meyer or Kapustinskii equations. In contrast, the measured (Born-Haber) and calculated values for compounds of the main groups (which have no CFSE) are in close agreement (Table 7.13). There is also close agreement in MnF<sub>2</sub> which has a *d*<sup>5</sup> configuration and a weak field ligand: hence there is no CFSE.

A plot of the lattice energies of the halides of the first row transition elements in the divalent state is given in Figure 7.13. In the solid, the coordination number of these metals is 6, and so the structures are analogous to octahedral complexes. The graphs for each halide show a minimum at Mn<sup>2+</sup>, which has a *d*<sup>5</sup> configuration. In a weak field this has a high-spin arrangement with zero CFSE. The configurations *d*<sup>0</sup> and *d*<sup>10</sup> also have zero CFSE. The broken line through Ca<sup>2+</sup>, Mn<sup>2+</sup> and Zn<sup>2+</sup> represents zero stabilization. The heights of other points above this line are the crystal field stabilization energies.

The hydration energies of the M<sup>2+</sup> ions of the first row transition elements are plotted in Figure 7.14a.

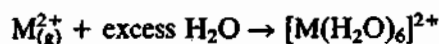

The ions Ca<sup>2+</sup>, Mn<sup>2+</sup> and Zn<sup>2+</sup> have *d*<sup>0</sup>, *d*<sup>5</sup> and *d*<sup>10</sup> configurations, and have zero CFSE. An almost straight line can be drawn through these points. The distance of the other points above this line corresponds to the CFSE. Values obtained in this way agree with those obtained spectroscopically. A similar graph of the M<sup>3+</sup> ions is shown in Figure 7.14b: here the *d*<sup>0</sup>, *d*<sup>5</sup> and *d*<sup>10</sup> species are Sc<sup>3+</sup>, Fe<sup>3+</sup> and Ga<sup>3+</sup>.

The ionic radii for M<sup>2+</sup> ions might be expected to decrease smoothly from Ca<sup>2+</sup> to Zn<sup>2+</sup> because of the increasing nuclear charge, and the poor shielding by *d* electrons. A plot of these radii is given in Figure 7.15. The change in size is not regular.

A smooth (broken) line is drawn through Ca<sup>2+</sup>, Mn<sup>2+</sup> and Zn<sup>2+</sup>. These

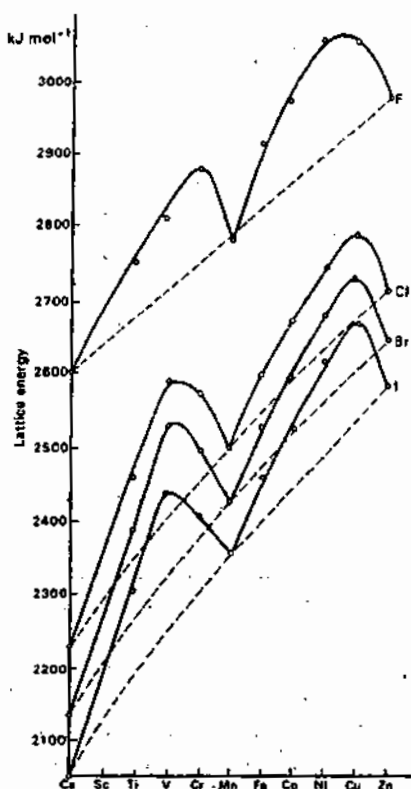

Figure 7.13 CFSE of dihalides of the first transition series. (After T.C. Waddington, Lattice energies and their significance in inorganic chemistry, *Advances in Inorganic Chemistry and Radiochemistry*, 1, Academic Press, New York, 1959.)

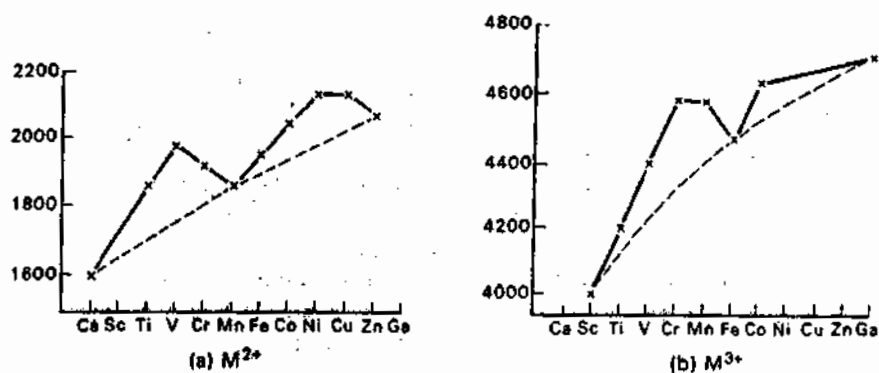

Figure 7.14 Enthalpies of hydration for  $M^{2+}$  and  $M^{3+}$ , in  $\text{kJ mol}^{-1}$ .

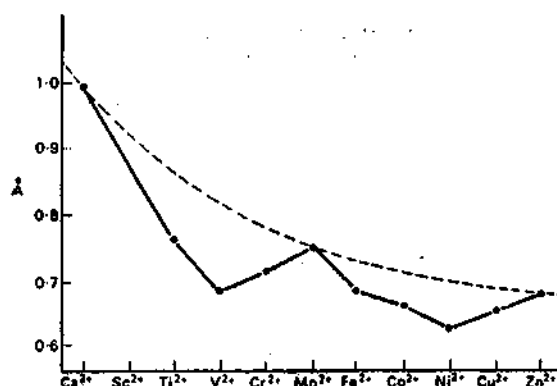

Figure 7.15 Octahedral ionic radii of  $M^{2+}$  for first row transition elements.

have  $d^0$ ,  $d^5$  and  $d^{10}$  configurations as the  $d$  orbitals are empty, half full or full. These arrangements constitute an almost spherical field round the nucleus. In  $Ti^{2+}$  the  $d$  electrons occupy orbitals away from the ligands, providing little or no shielding of the nuclear charge. Thus the ligands are drawn closer to the nucleus. The increased nuclear charge has an even greater effect in the case of  $V^{2+}$ . At  $Cr^{2+}$  the  $e_g$  level contains one electron. This is concentrated in the direction of the ligands, thus providing very good shielding. Thus the ligands can no longer approach so closely and the ionic radius increases. This increase in size is continued with the filling of the second  $e_g$  orbital at  $Mn^{2+}$ . The screening by the  $e_g$  orbitals is so good that the radius of  $Mn^{2+}$  is slightly smaller than it would be if it were in a truly spherical field. The same sequence of size changes is repeated in the second half of the series.

#### TETAGONAL DISTORTION OF OCTAHEDRAL COMPLEXES (JAHN-TELLER DISTORTION)

The shape of transition metal complexes is determined by the tendency of electron pairs to occupy positions as far away from each other as possible. This is the same as for the main group compounds and complexes. In addition, the shapes of transition metal complexes are affected by whether the  $d$  orbitals are symmetrically or asymmetrically filled.

Repulsion by six ligands in an octahedral complex splits the  $d$  orbitals on the central metal into  $t_{2g}$  and  $e_g$  levels. It follows that there is a corresponding repulsion between the  $d$  electrons and the ligands. If the  $d$  electrons are symmetrically arranged, they will repel all six ligands equally. Thus the structure will be a completely regular octahedron. The symmetrical arrangements of  $d$  electrons are shown in Table 7.14.

All other arrangements have an asymmetrical arrangement of  $d$  electrons. If the  $d$  electrons are asymmetrically arranged, they will repel some ligands in the complex more than others. Thus the structure is distorted because some ligands are prevented from approaching the metal



Table 7.14 Symmetrical electronic arrangements

Electronic configuration	$t_{2g}$	$e_g$	Nature of ligand field	Examples
$d^0$			Strong or weak	$Ti^{IV}O_2$ , $[Ti^{IV}F_6]^{2-}$ $[Ti^{IV}Cl_6]^{2-}$
$d^3$			Strong or weak	$[Cr^{III}(oxalate)_3]^{3-}$ $[Cr^{III}(H_2O)_6]^{3+}$
$d^5$			Weak	$[Mn^{II}F_6]^{4-}$ $[Fe^{III}F_6]^{3-}$
$d^6$			Strong	$[Fe^{II}(CN)_6]^{4-}$ $[Co^{III}(NH_3)_6]^{3+}$
$d^8$			Weak	$[Ni^{II}F_6]^{4-}$ $[Ni^{II}(H_2O)_6]^{2+}$
$d^{10}$			Strong or weak	$[Zn^{II}(NH_3)_6]^{2+}$ $[Zn^{II}(H_2O)_6]^{2+}$

as closely as others. The  $e_g$  orbitals point directly at the ligands. Thus asymmetric filling of the  $e_g$  orbitals results in some ligands being repelled more than others. This causes a significant distortion of the octahedral shape. In contrast the  $t_{2g}$  orbitals do not point directly at the ligands, but point in between the ligand directions. Thus asymmetric filling of the  $t_{2g}$  orbitals has only a very small effect on the stereochemistry. Distortion caused by asymmetric filling of the  $t_{2g}$  orbitals is usually too small to measure. The electronic arrangements which will produce a large distortion are shown in Table 7.15.

The two  $e_g$  orbitals  $d_{x^2-y^2}$  and  $d_{z^2}$  are normally degenerate. However, if they are asymmetrically filled then this degeneracy is destroyed, and the two orbitals are no longer equal in energy. If the  $d_{z^2}$  orbital contains one

Table 7.15 Asymmetrical electronic arrangements

Electronic configuration	$t_{2g}$	$e_g$	Nature of ligand field	Examples
$d^4$			Weak field (high-spin complex)	Cr(+II), Mn(+III)
$d^7$			Strong field (low-spin complex)	Co(+II), Ni(+III)
$d^9$			Either strong or weak	Cu(+II)

more electron than the  $d_{x^2-y^2}$  orbital then the ligands approaching along  $+z$  and  $-z$  will encounter greater repulsion than the other four ligands. The repulsion and distortion result in elongation of the octahedron along the  $z$  axis. This is called tetragonal distortion. Strictly it should be called tetragonal elongation. This form of distortion is commonly observed.

If the  $d_{x^2-y^2}$  orbital contains the extra electron, then elongation will occur along the  $x$  and  $y$  axes. This means that the ligands approach more closely along the  $z$  axis. Thus there will be four long bonds and two short bonds. This is equivalent to compressing the octahedron along the  $z$  axis, and is called tetragonal compression. Tetragonal elongation is much more common than tetragonal compression, and it is not possible to predict which will occur.

For example, the crystal structure of  $\text{CrF}_2$  is a distorted rutile ( $\text{TiO}_2$ ) structure.  $\text{Cr}^{2+}$  is octahedrally surrounded by six  $\text{F}^-$ , and there are four  $\text{Cr}-\text{F}$  bonds of length 1.98–2.01 Å, and two longer bonds of length 2.43 Å. The octahedron is said to be tetragonally distorted. The electronic arrangement in  $\text{Cr}^{2+}$  is  $d^4$ .  $\text{F}^-$  is a weak field ligand, and so the  $t_{2g}$  level contains three electrons and the  $e_g$  level contains one electron. The  $d_{x^2-y^2}$  orbital has four lobes whilst the  $d_{z^2}$  orbital has only two lobes pointing at the ligands. To minimize repulsion with the ligands, the single  $e_g$  electron will occupy the  $d_{z^2}$  orbital. This is equivalent to splitting the degeneracy of the  $e_g$  level so that  $d_{z^2}$  is of lower energy, i.e. more stable, and  $d_{x^2-y^2}$  is of higher energy, i.e. less stable. Thus the two ligands approaching along the  $+z$  and  $-z$  directions are subjected to greater repulsion than the four ligands along  $+x$ ,  $-x$ ,  $+y$  and  $-y$ . This causes tetragonal distortion with four short bonds and two long bonds. In the same way  $\text{MnF}_3$  contains  $\text{Mn}^{3+}$  with a  $d^4$  configuration, and forms a tetragonally distorted octahedral structure.

Many  $\text{Cu}(+II)$  salts and complexes also show tetragonally distorted octahedral structures.  $\text{Cu}^{2+}$  has a  $d^9$  configuration:



To minimize repulsion with the ligands, two electrons occupy the  $d_{z^2}$  orbital and one electron occupies the  $d_{x^2-y^2}$  orbital. Thus the two ligands along  $+z$  and  $-z$  are repelled more strongly than are the other four ligands (see Chapter 27, under  $+II$  state for copper).

The examples above show that whenever the  $d_{z^2}$  and  $d_{x^2-y^2}$  orbitals are unequally occupied, distortion occurs. This is known as Jahn–Teller distortion. The Jahn–Teller theorem states that 'Any non-linear molecular system in a degenerate electronic state will be unstable, and will undergo some sort of distortion to lower its symmetry and remove the degeneracy'. More simply, molecules or complexes (of any shape except linear), which have an unequally filled set of orbitals (either  $t_{2g}$  or  $e_g$ ), will be distorted. In octahedral complexes distortions from the  $t_{2g}$  level are too small to be

detected. However, distortions resulting from uneven filling of the  $e_g$  orbitals are very important.

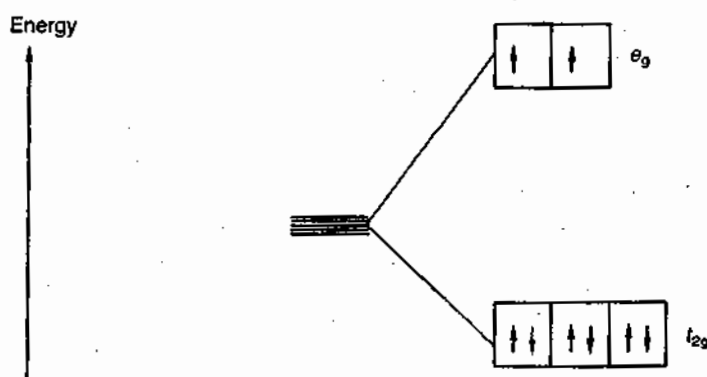

Figure 7.16  $d^8$  arrangement in weak octahedral field.

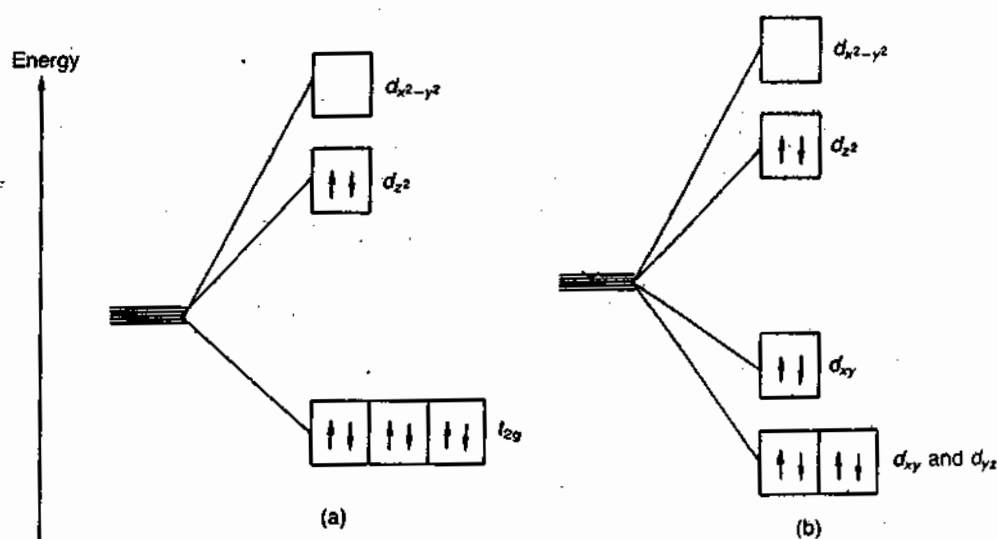
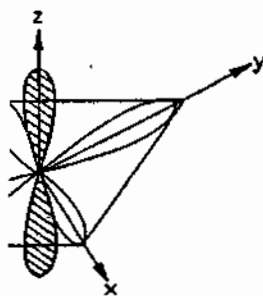

Figure 7.17  $d^8$  arrangement in very strong octahedral field. Tetragonal distortion splits (a) the  $e_g$  level; and (b) also splits the  $t_{2g}$  level. The  $d_{xy}$  orbital is higher in energy than the  $d_{xz}$  or  $d_{yz}$ . (For simplicity this is sometimes ignored.)

## SQUARE PLANAR ARRANGEMENTS

If the central metal ion in a complex has a  $d^8$  configuration, six electrons will occupy the  $t_{2g}$  orbitals and two electrons will occupy the  $e_g$  orbitals. The arrangement is the same in a complex with weak field ligands. The electrons are arranged as shown in Figure 7.16. The orbitals are symmetrically filled, and a regular octahedral complex is formed, for example by  $[\text{Ni}^{\text{II}}(\text{H}_2\text{O})_6]^{2+}$  and  $[\text{Ni}^{\text{II}}(\text{NH}_3)_6]^{2+}$ .

The single electron in the  $d_{x^2-y^2}$  orbital is being repelled by four ligands, whilst the electron in the  $d_{z^2}$  orbital is only being repelled by two ligands. Thus the energy of the  $d_{x^2-y^2}$  increases relative to that of  $d_{z^2}$ . If the ligand field is sufficiently strong, the difference in energy between these two orbitals becomes larger than the energy needed to pair the electrons. Under these conditions, a more stable arrangement arises when both the  $e_g$  electrons pair up and occupy the lower energy  $d_{z^2}$  orbital. This leaves the  $d_{x^2-y^2}$  orbital empty (Figure 7.17). Thus four ligands can now approach along the  $+x$ ,  $-x$ ,  $+y$  and  $-y$  directions without any difficulty, as the  $d_{x^2-y^2}$  orbital is empty. However, ligands approaching along the  $+z$  and  $-z$  directions meet very strong repulsive forces from the filled  $d_{z^2}$  orbital (Figure 7.18). Thus only four ligands succeed in bonding to the metal. A square planar complex is formed, the attempt to form an octahedral complex being unsuccessful.



8  $d^8$  arrangement,  $d_{z^2}$ . (The  $d_{x^2-y^2}$  orbital is empty.)

The amount of tetragonal distortion that occurs depends on the particular metal ion and ligands. Sometimes the tetragonal distortion may become so large that the  $d_{z^2}$  orbital is lower in energy than the  $d_{xy}$  orbital as shown in Figure 7.19. In square planar complexes of  $\text{Co}^{II}$ ,  $\text{Ni}^{II}$  and  $\text{Cu}^{II}$  the  $d_{z^2}$  orbital has nearly the same energy as the  $d_{xz}$  and  $d_{yz}$  orbitals. In  $[\text{PtCl}_4]^{2-}$  the  $d_{z^2}$  orbital is lower in energy than the  $d_{xz}$  and  $d_{yz}$  orbitals.

Square planar complexes are formed by  $d^8$  ions with strong field ligands, for example  $[\text{Ni}^{II}(\text{CN})_4]^{2-}$ . The crystal field splitting  $\Delta_o$  is larger for second and third row transition elements, and for more highly charged species. All the complexes of  $\text{Pt}(+II)$  and  $\text{Au}(+III)$  are square planar – including those with weak field ligands such as halide ions.

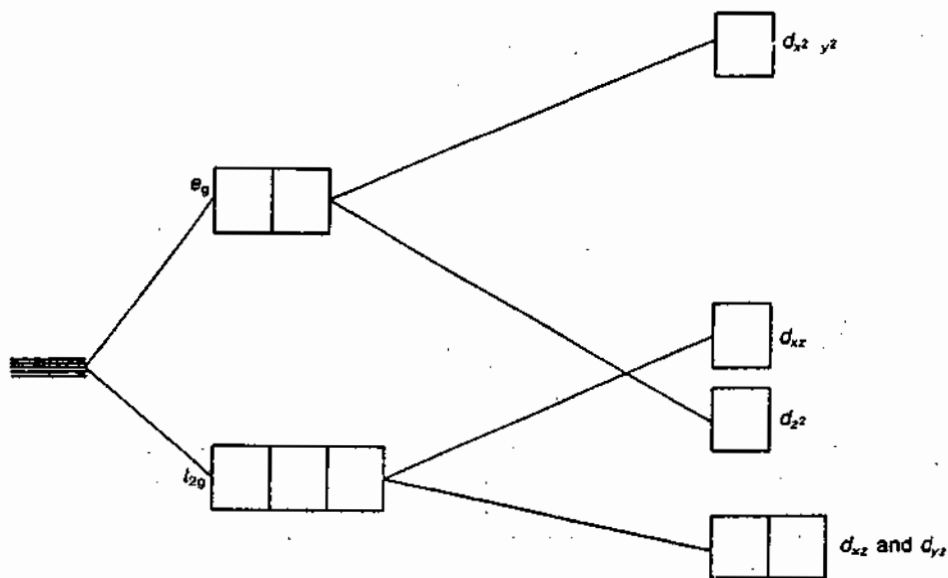

Figure 7.19 Tetragonal distortion.

Table 7.16 Ions that form square planar complexes

Electronic configuration	Ions	Type of field	Number of unpaired electrons
$d^4$	Cr(+II)	Weak	4
$d^6$	Fe(+II)	(Haem)	2
$d^7$	Co(+II)	Strong	1
$d^8$	Ni(+II), Rh(+I), Ir(+I)	Strong	0
	Pd(+II), Pt(+II), Au(+III)	Strong and weak	0
$d^9$	Cu(+II), Ag(+II)	Strong and weak	1

Square planar structures can also arise from  $d^4$  ions in a weak ligand field. In this case the  $d_{z^2}$  orbital only contains one electron.

### TETRAHEDRAL COMPLEXES

A regular tetrahedron is related to a cube. One atom is at the centre of the cube, and four of the eight corners of the cube are occupied by ligands as shown in Figure 7.20.

The directions  $x$ ,  $y$  and  $z$  point to the centres of the faces of the cube. The  $e_g$  orbitals point along  $x$ ,  $y$  and  $z$  (that is to the centres of the faces). The  $t_{2g}$  orbitals point between  $x$ ,  $y$  and  $z$  (that is towards the centres of the edges of the cube) (Figure 7.21).

The direction of approach of the ligands does not coincide exactly with

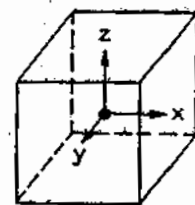
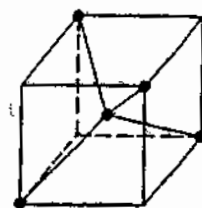

Figure 7.20 Relation of a tetrahedron to a cube.

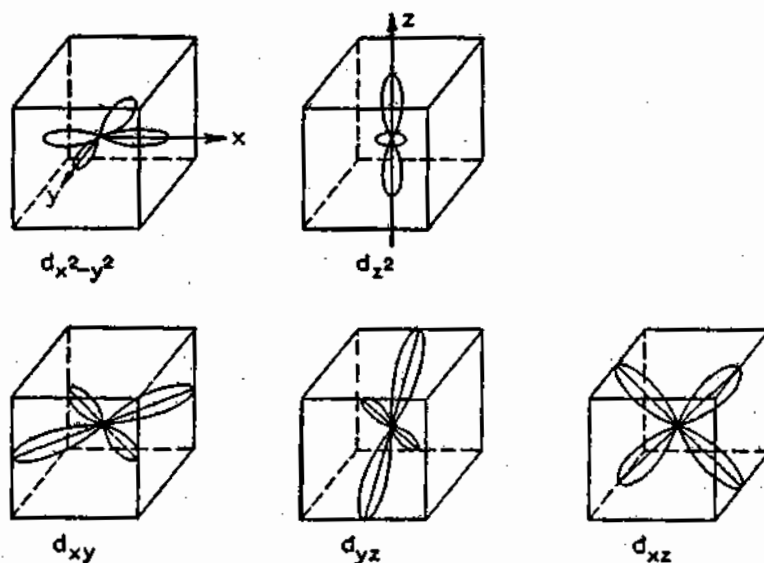

Figure 7.21 Orientation of  $d$  orbitals relative to a cube.

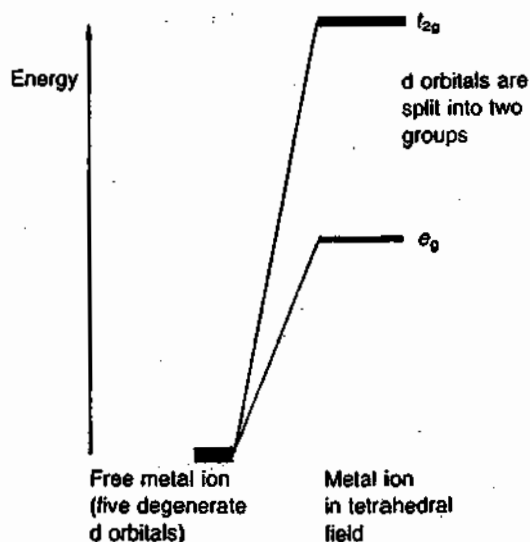

Figure 7.22 Crystal field splitting of energy levels in a tetrahedral field.

either the  $e_g$  or the  $t_{2g}$  orbitals. The angle between an  $e_g$  orbital, the central metal and the ligand is half the tetrahedral angle  $= 109^\circ 28' / 2 = 54^\circ 44'$ . The angle between a  $t_{2g}$  orbital, the central metal and the ligand is  $35^\circ 16'$ . Thus the  $t_{2g}$  orbitals are nearer to the direction of the ligands than the  $e_g$  orbitals. (Alternatively the  $t_{2g}$  orbitals are half the side of the cube away from the approach of the ligands, whilst the  $e_g$  orbitals are half the diagonal of the cube away.) The approach of the ligands raises the energy of both sets of orbitals. The energy of the  $t_{2g}$  orbitals is raised most because they are closest to the ligands. This crystal field splitting is the opposite way round to that in octahedral complexes (Figure 7.22).

The  $t_{2g}$  orbitals are  $0.4\Delta_t$  above the weighted average energy of the two groups (the Bari centre) and the  $e_g$  orbitals are  $0.6\Delta_t$  below the average (Figure 7.23).

The magnitude of the crystal field splitting  $\Delta_t$  in tetrahedral complexes is considerably less than in octahedral fields. There are two reasons for this:

1. There are only four ligands instead of six, so the ligand field is only two thirds the size: hence the ligand field splitting is also two thirds the size.
2. The direction of the orbitals does not coincide with the direction of the ligands. This reduces the crystal field splitting by roughly a further two thirds.

Thus the tetrahedral crystal field splitting  $\Delta_t$  is roughly  $2/3 \times 2/3 = 4/9$  of the octahedral crystal field splitting  $\Delta_o$ . Strong field ligands cause a bigger energy difference between  $t_{2g}$  and  $e_g$  than weak field ligands. However, the tetrahedral splitting  $\Delta_t$  is always much smaller than the octahedral splitting  $\Delta_o$ . Thus it is never energetically favourable to pair electrons, and all tetrahedral complexes are high-spin.

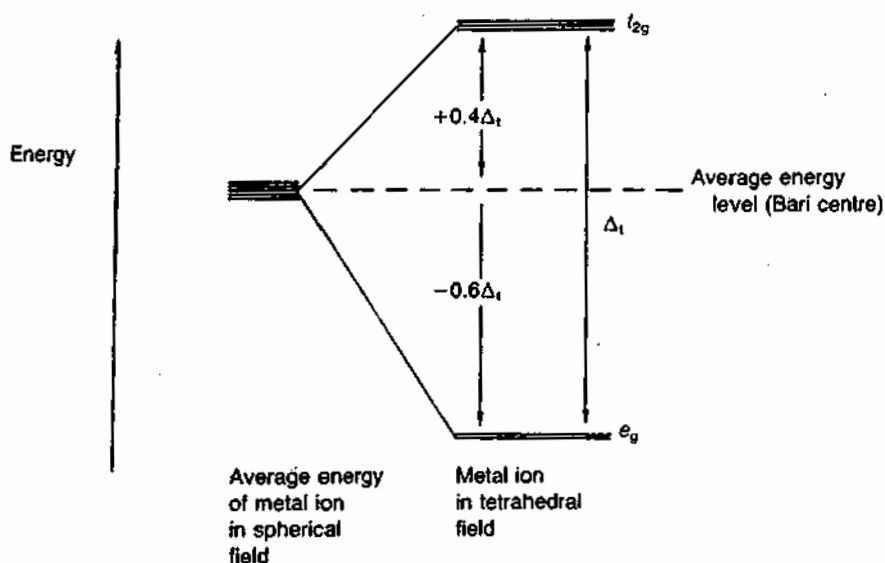

Figure 7.23 Energy levels for  $d$  orbitals in a tetrahedral field.

The CFSE in both octahedral and tetrahedral environments is given in Table 7.17. This shows that for  $d^0$ ,  $d^5$  and  $d^{10}$  arrangements the CFSE is zero in both octahedral and tetrahedral complexes. For all other electronic arrangements there is some CFSE, and the octahedral CFSE is greater than the tetrahedral CFSE. It follows that octahedral complexes are generally more stable and more common than tetrahedral complexes. This is partly because there are six bond energy terms rather than four, and partly because there is a larger CFSE term. Despite this some tetrahedral complexes are formed, and are stable. Tetrahedral complexes are favoured:

1. Where the ligands are large and bulky and could cause crowding in an octahedral complex.
2. Where attainment of a regular shape is important. For tetrahedral structures  $d^0$ ,  $d^2$ ,  $d^5$ ,  $d^7$  and  $d^{10}$  configurations are regular. Some tetrahedral complexes which are regular are:  $\text{Ti}^{\text{IV}}\text{Cl}_4$  ( $e_g^0, t_{2g}^0$ ),  $[\text{Mn}^{\text{VII}}\text{O}_4]^-$  ( $e_g^0, t_{2g}^0$ ),  $[\text{Fe}^{\text{VI}}\text{O}_4]^{2-}$  ( $e_g^2, t_{2g}^0$ ),  $[\text{Fe}^{\text{III}}\text{Cl}_4]^-$  ( $e_g^2, t_{2g}^3$ ),  $[\text{Co}^{\text{II}}\text{Cl}_4]^{2-}$  ( $e_g^4, t_{2g}^3$ ) and  $[\text{Zn}^{\text{II}}\text{Cl}_4]^{2-}$  ( $e_g^4, t_{2g}^0$ ).
3. When the ligands are weak field, and the loss in CFSE is thus less important.
4. Where the central metal has a low oxidation state. This reduces the magnitude of  $\Delta$ .
5. Where the electronic configuration of the central metal is  $d^0$ ,  $d^5$  or  $d^{10}$  as there is no CFSE.
6. Where the loss of CFSE is small, e.g.  $d^1$  and  $d^6$  where the loss in CFSE is  $0.13\Delta_o$  or  $d^2$  and  $d^7$  where the loss is  $0.27\Delta_o$ .

Many transition metal chlorides, bromides and iodides form tetrahedral structures.

Table 7.17 CFSE and electronic arrangements in tetrahedral complexes

Number of $d$ electrons	Arrangement of electrons		Spin only magnetic moment $\mu(D)$	Tetrahedral CFSE $\Delta_t$	Tetrahedral CFSE scaled for comparison with octahedral values, assuming $\Delta_t = \frac{4}{9}\Delta_o$	Octahedral CFSE $\Delta_o$	
	$e_g$	$t_{2g}$				Weak field	Strong field
$d^1$	$\uparrow$		1.73	-0.6	-0.27	-0.4	-0.4
$d^2$	$\uparrow \uparrow$		2.83	-1.2	-0.53	-0.8	-0.8
$d^3$	$\uparrow \uparrow$	$\uparrow$	3.87	$-1.2 + 0.4 = -0.8$	-0.36	-1.2	-1.2
$d^4$	$\uparrow \uparrow$	$\uparrow \uparrow$	4.90	$-1.2 + 0.8 = -0.4$	-0.18	-0.6	-1.6
$d^5$	$\uparrow \uparrow$	$\uparrow \uparrow \uparrow$	5.92	$-1.2 + 1.2 = 0.0$	0.00	0.0	-2.0
$d^6$	$\uparrow \downarrow \uparrow$	$\uparrow \uparrow \uparrow$	4.90	$-1.8 + 1.2 = -0.6$	-0.27	-0.4	-2.4
$d^7$	$\uparrow \downarrow \uparrow \downarrow$	$\uparrow \uparrow \uparrow$	3.87	$-2.4 + 1.2 = -1.2$	-0.53	-0.8	-1.8
$d^8$	$\uparrow \downarrow \uparrow \downarrow$	$\uparrow \downarrow \uparrow \uparrow$	2.83	$-2.4 + 1.6 = -0.8$	-0.36	-1.2	-1.2
$d^9$	$\uparrow \downarrow \uparrow \downarrow$	$\uparrow \downarrow \uparrow \downarrow \uparrow$	1.73	$-2.4 + 2.0 = -0.4$	-0.18	-0.6	-0.6
$d^{10}$	$\uparrow \downarrow \uparrow \downarrow$	$\uparrow \downarrow \uparrow \downarrow \uparrow \downarrow$	0.00	$-2.4 + 2.4 = 0.0$	0.00	0.0	0.0

## CHELATES

Some of the factors that favour complex formation have already been mentioned:

1. Small highly charged ions with suitable vacant orbitals of the right energy.
2. The attainment of a noble gas structure (effective atomic number rule).
3. The attainment of a symmetrical shape and a high CFSE.

In some complexes a ligand occupies more than one coordination position. Thus more than one atom in the ligand is bonded to the central metal. For example, ethylenediamine forms a complex with copper ions:



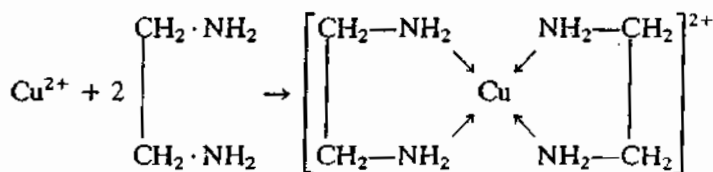

In this complex the copper is surrounded by four  $-\text{NH}_2$  groups. Thus each ethylenediamine molecule is bonded to the copper in two places. For this reason ethylenediamine is called a bidentate group or ligand. (Bidentate means literally two teeth!) A ring structure is thus formed (in this case a pair of five-membered rings) and such ring structures are called chelates. (Chelos is the Greek word for crab.) Chelated complexes are more stable than similar complexes with unidentate ligands, as dissociation of the complex involves breaking two bonds rather than one. Some common polydentate ligands are listed in Figure 7.24.

The more rings that are formed, the more stable the complex is. Chelating agents with three, four and six donor atoms are known and are termed tridentate, tetradentate and hexadentate ligands. An important example of the latter is ethylenediaminetetraacetic acid. This bonds through two N and four O atoms to the metal, and so forms five rings. Due to this

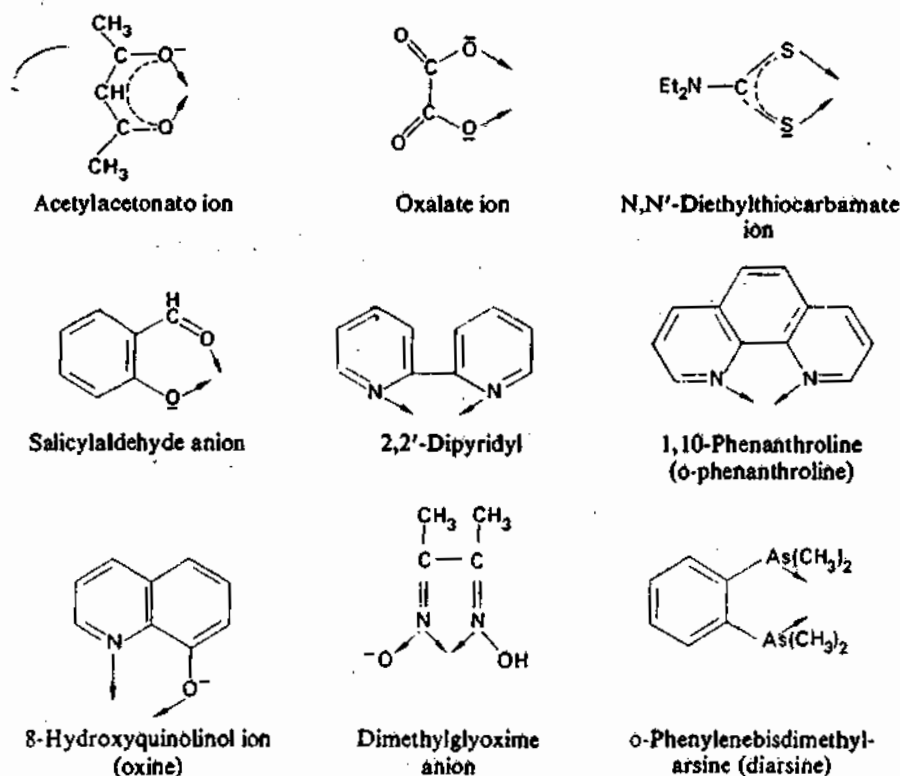

Figure 7.24 Some common polydentate ligands.

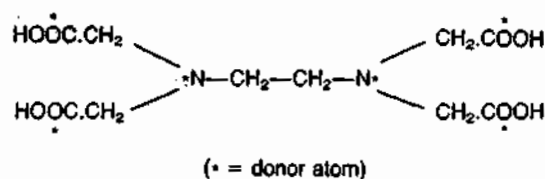

Figure 7.25 EDTA.

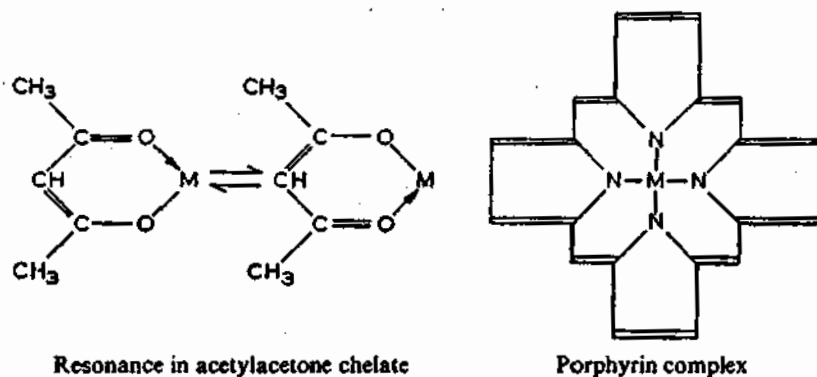

Figure 7.26 Some chelate complexes.

bonding, EDTA can form complexes with most metal ions. Even complexes with large ions such as  $\text{Ca}^{2+}$  are relatively stable. (The  $\text{Ca}^{2+}$ -EDTA complex is only formed completely at pH 8, not at lower pH.)

Chelate compounds are even more stable when they contain a system of alternate double and single bonds. This is better represented as a system in which electron density is delocalized and spread over the ring. Examples of this include acetylacetonate and porphyrin complexes with metals (Figure 7.26).

Several chelate compounds are of biological importance. Haemoglobin in the red blood cells contains an iron-porphyrin complex. Chlorophyll in green plants contains a magnesium-porphyrin complex. Vitamin  $\text{B}_{12}$  is a cobalt complex and the cytochrome oxidase enzymes contain iron and copper. The body contains several materials which will form chelate compounds with metals, for example adrenaline, citric acid and cortisone. Metal poisoning by lead, copper, iron, chromium and nickel results in these materials forming unwanted complexes, thus preventing normal metabolism. For this reason dermatitis from chromium or nickel salts is treated with EDTA cream. Lead and copper poisoning are treated by drinking an aqueous solution of EDTA. This complexes with the unwanted lead or copper ions. Unfortunately it also complexes with other metal ions which are needed, particularly  $\text{Ca}^{2+}$ . The metal-EDTA complexes are excreted in the urine. (The problem of excreting  $\text{Ca}^{2+}$  may be partly overcome by using the Ca-EDTA complex rather than EDTA itself.)

## MAGNETISM

The magnetic moment can be measured using a Gouy balance (see Chapter 18). If we assume that the magnetic moment arises entirely from unpaired electron spins then the 'spin only' formula can be used to estimate  $n$ , the number of unpaired electrons. This gives reasonable agreement for complexes of the first row of transition metals.

$$\mu_s = \sqrt{n(n+2)}$$

Once the number of unpaired electrons is known, either the valence bond or the crystal field theory can be used to work out the shape of the complex, the oxidation state of the metal, and, for octahedral complexes, whether inner or outer  $d$  orbitals are used. For example, Co(+III) forms many complexes, all of which are octahedral. Most of them are diamagnetic, but  $[\text{CoF}_6]^{3-}$  is paramagnetic with an observed magnetic moment of 5.3 BM. Crystal field theory explains this (Figure 7.27).

Co(+II) forms both tetrahedral and square planar four-coordinate complexes. These can be distinguished by magnetic measurements (Figure 7.28).

However, orbital angular momentum also contributes to a greater or lesser degree to the magnetic moment. For the second and third row transition elements not only is this contribution significant, but spin orbit coupling may occur. Because of this, the 'spin only' approximation is no longer valid, and there is extensive temperature dependent paramagnetism. Thus the simple interpretation of magnetic moments in terms of the number of unpaired electrons cannot be extended from the first row of

**Co<sup>3+</sup> octahedral complex with strong field ligands**

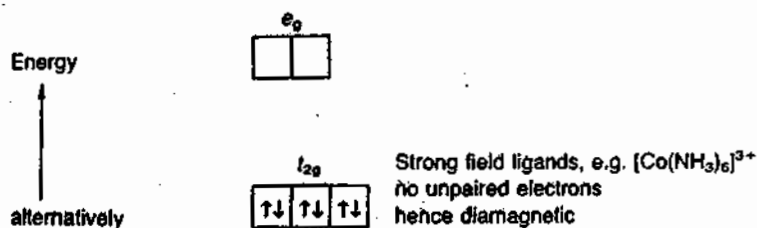

**Co<sup>3+</sup> octahedral complex with weak field ligands**

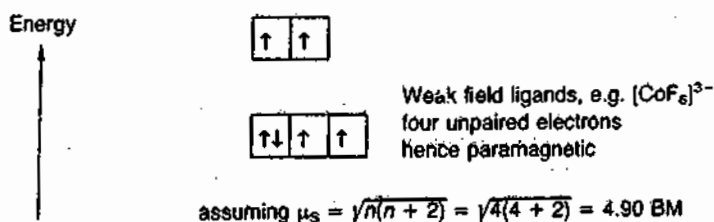

Figure 7.27 Co<sup>3+</sup> in high-spin and low-spin complexes.

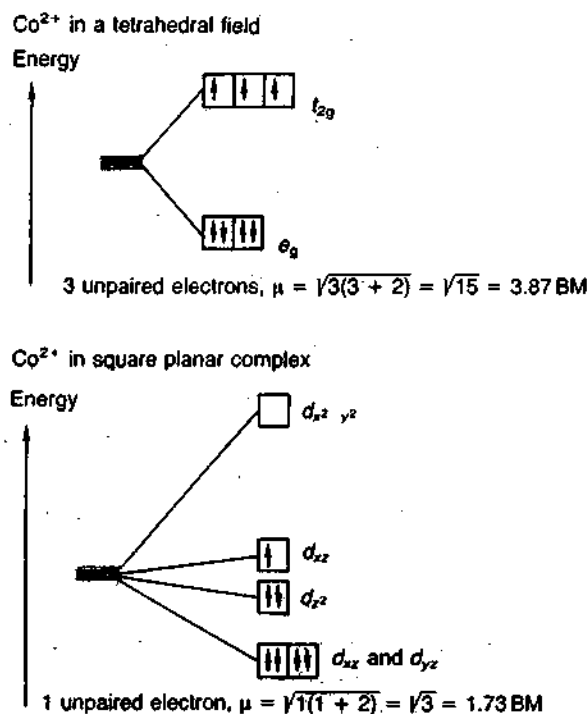

Figure 7.28 Co<sup>2+</sup> in tetrahedral and square planar complexes.

transition elements to the second and third rows. The temperature dependence is explained by the spin orbit coupling. This removes the degeneracy from the lowest energy level in the ground state. Thermal energy then allows a variety of levels to be populated.

#### EXTENSION OF THE CRYSTAL FIELD THEORY TO ALLOW FOR SOME COVALENCY

The crystal field theory is based on purely electrostatic attraction. At first sight this seems to be a most improbable assumption. Nevertheless, the theory is remarkably successful in explaining the shapes of complexes, their spectra and their magnetic properties. Calculations can be carried out quite simply. The disadvantage of the theory is that it ignores evidence that some covalent bonding does occur in at least some transition metal complexes:

1. Compounds in the zero oxidation state such as nickel carbonyl [Ni<sup>0</sup>(CO)<sub>4</sub>] have no electrostatic attraction between the metal and the ligands. Thus the bonding must be covalent.
2. The order of ligands in the spectrochemical series cannot be explained solely on electrostatic grounds.
3. There is some evidence from nuclear magnetic resonance and electron

spin resonance that there is some unpaired electron density on the ligands. This suggests the sharing of electrons, and hence some covalency.

The Racah interelectron repulsion parameter  $B$  is introduced into the interpretation of spectra. This makes some allowance for covalency arising from the delocalization of  $d$  electrons from the metal onto the ligand. If  $B$  is reduced below the value for a free metal ion, the  $d$  electrons are delocalized onto the ligand. The more  $B$  is reduced the greater the delocalization and the greater the amount of covalency. In a similar way an electron delocalization factor  $k$  can be used in interpreting magnetic measurements.

### MOLECULAR ORBITAL THEORY

The molecular orbital theory incorporates covalent bonding. Consider a first row transition element forming an octahedral complex, for example

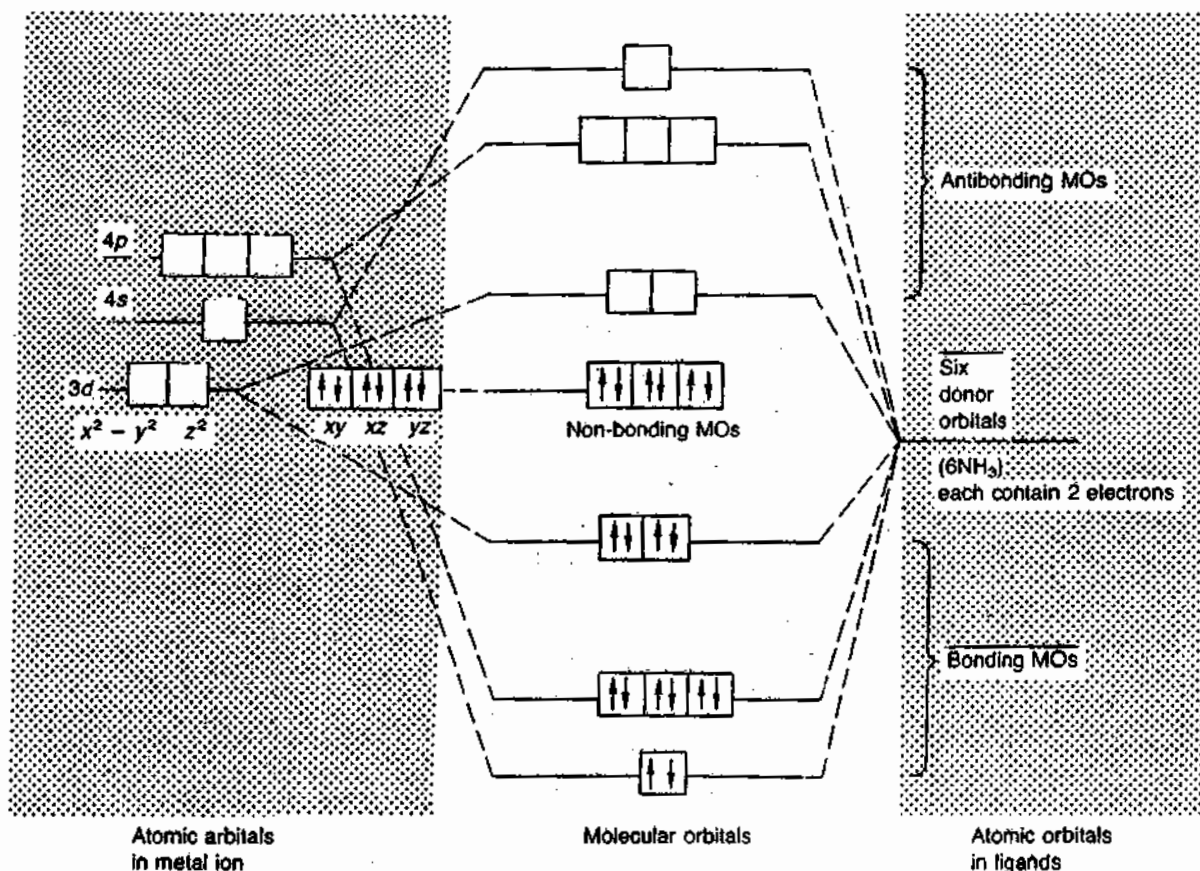

Figure 7.29 Molecular orbital diagram for  $[\text{Co}^{\text{III}}(\text{NH}_3)_6]^{3+}$ .

$[\text{Co}^{\text{III}}(\text{NH}_3)_6]^{3+}$ . The atomic orbitals on  $\text{Co}^{3+}$  which are used to make molecular orbitals are  $3d_{x^2-y^2}$ ,  $3d_{z^2}$ ,  $4s$ ,  $4p_x$ ,  $4p_y$  and  $4p_z$ . A  $2p$  atomic orbital from each  $\text{NH}_3$  containing a lone pair is also used to make molecular orbitals. Thus there are 12 atomic orbitals, which combine to give 12 molecular orbitals (six bonding MOs and six antibonding MOs). The 12 electrons from the six ligand lone pairs are placed in the six bonding MOs. This accounts for the six bonds. The transition metal  $\text{Co}^{3+}$  has other  $d$  orbitals, which have so far been ignored. These are the  $3d_{xy}$ ,  $3d_{xz}$  and  $3d_{yz}$  orbitals. These form non-bonding MOs, and in  $\text{Co}^{3+}$  they contain six electrons, but contribute nothing to the bonding. The antibonding MOs are all empty. The arrangement is shown in Figure 7.29. We would predict that the complex should be diamagnetic as all the electrons are paired. The complex should be coloured since promotion of electrons from the non-bonding MOs to the antibonding  $e_g^*$  MOs is feasible. The energy jump  $\Delta_o$  is  $23\,000\text{ cm}^{-1}$ . The six non-bonding  $d$  electrons are paired in this complex because  $\Delta_o$  is larger than the pairing energy of  $19\,000\text{ cm}^{-1}$ .

A similar MO diagram can be drawn for the complex  $[\text{Co}^{\text{III}}\text{F}_6]^{3-}$ .

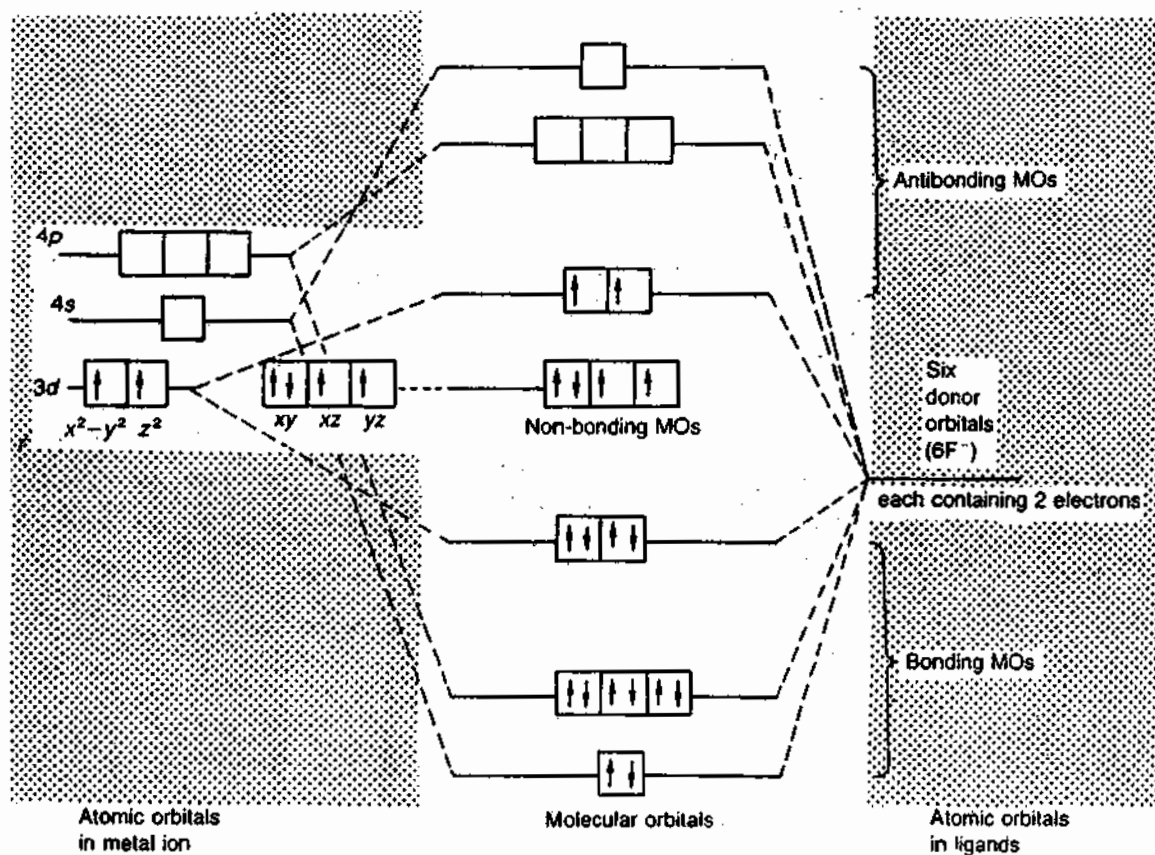

Figure 7.30 Molecular orbital diagram for  $[\text{CoF}_6]^{3-}$ .

However, the energies of the  $2p$  orbitals on  $F^-$  are much lower than the energy of the corresponding orbital on N in  $NH_3$ . This alters the spacing of the MO energy levels (Figure 7.30). Spectroscopic measurements show that  $\Delta_o$  is  $13000\text{ cm}^{-1}$ . Thus the gap between the non-bonding MOs and the antibonding  $e_g^*$  MOs is less than the pairing energy of  $19000\text{ cm}^{-1}$ . Thus the non-bonding  $d$  electrons do not pair up as in the  $[Co(NH_3)_6]^{3+}$  complex because there is a net gain in energy if electrons are left unpaired. Thus  $[CoF_6]^{3-}$  has four unpaired electrons and is a high-spin complex, whilst  $[Co(NH_3)_6]^{3+}$  has no unpaired electrons and is a low-spin complex.

Thus the MO theory explains the magnetic properties and spectra of complexes equally as well as the crystal field theory. Both theories rely on spectra to measure the energy of  $\Delta_o$ . Either theory may be used depending on which is the most convenient.

The MO theory is based on wave mechanics and so has the disadvantage that enthalpies of formation and bond energies cannot be calculated directly. So far we have considered  $\sigma$  bonding between ligands and the central metal. The MO theory has the great advantage that it is easily extended to cover  $\pi$  bonding.  $\pi$  bonding helps to explain how metals in low oxidation states (e.g.  $[Ni^0(CO)_4]$ ) can form complexes. It is impossible to explain any attractive force in such a complex using the crystal field theory because of the lack of charge on the metal.  $\pi$  bonding also helps to explain the position of some ligands in the spectrochemical series. There are two cases:

1. Where the ligands act as  $\pi$  acceptors, by accepting electrons from the central metal. Examples include  $CO$ ,  $CN^-$ ,  $NO^+$  and phosphines.
2. Where the ligands act as  $\pi$  donors and transfer charge from ligand to metal in  $\pi$  interactions as well as  $\sigma$  interactions.  $\pi$  bonding of this kind commonly occurs in oxoions of metals in high oxidation states, e.g.  $[Mn^{VII}O_4]^-$  and  $[Cr^{VI}O_4]^{2-}$ .

#### $\pi$ acceptors

Ligands such as  $CO$ ,  $CN^-$  and  $NO^+$  have empty  $\pi$  orbitals with the correct symmetry to overlap with the metal  $t_{2g}$  orbitals, forming  $\pi$  bonds. This is often described as back bonding. Normally the  $\pi$  orbitals on the ligands are of higher energy than the metal  $t_{2g}$  orbitals. No more electrons are added to the scheme as the ligand  $\pi$  orbitals are empty, but the  $\pi$  interaction increases the value of  $\Delta_o$ . This accounts for the position of these ligands as 'strong field ligands' at the right of the spectrochemical series.

#### $\pi$ donors

The ligand has filled  $\pi$  orbitals which overlap with the metal  $t_{2g}$  orbitals, giving a  $\pi$  bond. Thus electron density is transferred from the ligand to the metal. The  $\sigma$  bonding also transfers charge to the metal. This type of complex is favoured when the central metal has a high oxidation state,

and 'is short of electrons'. The ligand  $\pi$  orbitals are lower in energy than the metal  $t_{2g}$  orbitals. Delocalizing  $\pi$  electrons from the ligand to the metal in this way reduces the value of  $\Delta$ . It is not always clear if  $\pi$  donor bonding has occurred, but it is most likely with ligands at the left of the spectrochemical series.

### NOMENCLATURE OF COORDINATION COMPOUNDS

The International Union of Pure and Applied Chemistry (IUPAC) publication *Nomenclature of Inorganic Chemistry* (1989), Blackwell Scientific Publishers, contains the rules for the systematic naming of coordination compounds. The basic rules are summarized here.

1. The positive ion is named first followed by the negative ion.
2. When writing the name of a complex, the ligands are quoted in alphabetical order, regardless of their charge (followed by the metal).
3. When writing the formula of complexes, ligands are named before the metal. The coordinated groups are listed in the order: negative ligands, neutral ligands, positive ligands (and alphabetically according to the first symbol within each group).

(a) The names of negative ligands end in -o, for example:

F <sup>-</sup>	fluoro	H <sup>-</sup>	hydrido	HS <sup>-</sup>	mercapto
Cl <sup>-</sup>	chloro	OH <sup>-</sup>	hydroxo	S <sup>2-</sup>	thio
Br <sup>-</sup>	bromo	O <sup>2-</sup>	oxo	CN <sup>-</sup>	cyano
I <sup>-</sup>	iodo	O <sub>2</sub> <sup>2-</sup>	peroxo	NO <sub>2</sub> <sup>-</sup>	nitro

(b) Neutral groups have no special endings. Examples include NH<sub>3</sub> ammine, H<sub>2</sub>O aqua, CO carbonyl and NO nitrosyl. The ligands N<sub>2</sub> and O<sub>2</sub> are called dinitrogen and dioxygen. Organic ligands are usually given their common names, for example phenyl, methyl, ethylenediamine, pyridine, triphenylphosphine.

(c) Positive groups end in -ium, e.g. NH<sub>2</sub>—NH<sub>2</sub> hydrazinium.

4. Where there are several ligands of the same kind, we normally use the prefixes di, tri, tetra, penta and hexa to show the number of ligands of that type. An exception occurs when the name of the ligand includes a number, e.g. dipyridyl or ethylenediamine. To avoid confusion in such cases, bis, tris and tetrakis are used instead of di, tri and tetra and the name of the ligand is placed in brackets.
5. The oxidation state of the central metal is shown by a Roman numeral in brackets immediately following its name (i.e. no space, e.g. titanium(III)).
6. Complex positive ions and neutral molecules have no special ending but complex negative ions end in -ate.
7. If the complex contains two or more metal atoms, it is termed polynuclear. The bridging ligands which link the two metal atoms together are indicated by the prefix  $\mu$ -. If there are two or more bridging groups of the same kind, this is indicated by di- $\mu$ -, tri- $\mu$ - etc. Bridging



groups are listed alphabetically with the other groups unless the symmetry of the molecule allows a simpler name. If a bridging group bridges more than two metal atoms it is shown as  $\mu_3$ ,  $\mu_4$ ,  $\mu_5$  or  $\mu_6$  to indicate how many atoms it is bonded to.

8. Sometimes a ligand may be attached through different atoms. Thus  $M-NO_2$  is called nitro and  $M-ONO$  is called nitrito. Similarly the SCN group may bond  $M-SCN$  thiocyanato or  $M-NCS$  isothiocyanato. These may be named systematically thiocyanato-S or thiocyanato-N to indicate which atom is bonded to the metal. This convention may be extended to other cases where the mode of linkage is ambiguous.
9. If any lattice components such as water or solvent of crystallization are present, these follow the name, and are preceded by the number of these groups in Arabic numerals.

These rules are illustrated by the following examples:

<i>Complex cations</i> <i>kation</i>	
$[Co(NH_3)_6]Cl_3$	Hexaamminecobalt(III) chloride
$[CoCl(NH_3)_5]^{2+}$	Pentaamminechlorocobalt(III) ion
$[CoSO_4(NH_3)_4]NO_3$	Tetraamminesulphatocobalt(III) nitrate
$[Co(NO_2)_3(NH_3)_3]$	Triamminetrinitrocobalt(III)
$[CoCl \cdot CN \cdot NO_2 \cdot (NH_3)_3]$	Triamminechlorocyanonitrocobalt(III)
$[Zn(NCS)_4]^{2+}$	Tetrathiocyanato-N-zinc(II)
$[Cd(SCN)_4]^{2+}$	Tetrathiocyanato-S-cadmium(II)

<i>Complex anions</i> <i>Anion</i>	
$Li[AlH_4]$	Lithium tetrahydridoaluminate(III) ( <i>lithium aluminium hydride</i> )
$Na_2[ZnCl_4]$	Sodium tetrachlorozincate(II)
$K_4[Fe(CN)_6]$	Potassium hexacyanoferrate(II)
$K_3[Fe(CN)_5NO]$	Potassium pentacyanonitrosylferrate(II)
$K_2[OsCl_5N]$	Potassium pentachloronitridoosmate(VI)
$Na_3[Ag(S_2O_3)_2]$	Sodium bis(thiosulphato)argentate(I)
$K_2[Cr(CN)_2O_2(O_2)NH_3]$	Potassium amminedicyanodioxoperoxo chromate(VI)

<i>Organic groups</i>	
$[Pt(py)_4][PtCl_4]$	Tetrapyridineplatinum(II) · tetrachloroplatinate(II)
$[Cr(en)_3]Cl_3$	<i>d</i> or <i>l</i> Tris(ethylenediamine)chromium(III) chloride
$[CuCl_2(CH_3NH_2)_2]$	Dichlorobis(dimethylamine)copper(II)
$Fe(C_5H_5)_2$	Bis(cyclopentadienyl)iron(II)
$[Cr(C_6H_6)_2]$	Bis(benzene)chromium(0)

*Bridging groups*

$[(\text{NH}_3)_5\text{Co} \cdot \text{NH}_2 \cdot \text{Co}(\text{NH}_3)_5](\text{NO}_3)_5$	$\mu$ -amidobis[pentaamminecobalt(III)] nitrate
$[(\text{CO})_3\text{Fe}(\text{CO})_3\text{Fe}(\text{CO})_3]$	Tri- $\mu$ -carbonyl-bis(tricarbonyliron(0)) ( <i>di iron enneacarbonyl</i> )
$[\text{Be}_4\text{O}(\text{CH}_3\text{COO})_6]$	Hexa- $\mu$ -acetato(O,O')- $\mu_4$ -oxo-tetraberyllium(II) ( <i>basic beryllium acetate</i> )

*Hydrates*

$\text{AlK}(\text{SO}_4)_2 \cdot 12\text{H}_2\text{O}$	Aluminium potassium sulphate 12-water
--	---------------------------------------

## ISOMERISM

Compounds that have the same chemical formula but different structural arrangements are called isomers. Because of the complicated formulae of many coordination compounds, the variety of bond types and the number of shapes possible, many different types of isomerism occur. Werner's classification into polymerization, ionization, hydrate linkage, coordination, coordination position, and geometric and optical isomerism is still generally accepted.

## Polymerization isomerism

This is not true isomerism because it occurs between compounds having the same empirical formula, but different molecular weights. Thus  $[\text{Pt}(\text{NH}_3)_2\text{Cl}_2]$ ,  $[\text{Pt}(\text{NH}_3)_4][\text{PtCl}_4]$ ,  $[\text{Pt}(\text{NH}_3)_4][\text{Pt}(\text{NH}_3)\text{Cl}_3]_2$  and  $[\text{Pt}(\text{NH}_3)_3\text{Cl}]_2[\text{PtCl}_4]$  all have the same empirical formula. Polymerization isomerism may be due to a different number of nuclei in the complex, as shown in Figure 7.31.

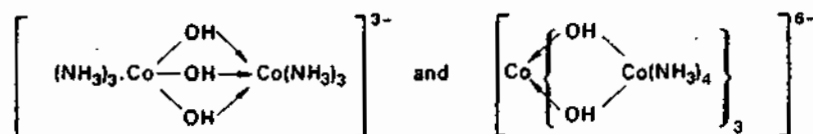

Figure 7.31 Polymerization isomers.

## Ionization isomerism

This type of isomerism is due to the exchange of groups between the complex ion and the ions outside it.  $[\text{Co}(\text{NH}_3)_5\text{Br}]\text{SO}_4$  is red-violet. An aqueous solution gives a white precipitate of  $\text{BaSO}_4$  with  $\text{BaCl}_2$  solution, thus confirming the presence of free  $\text{SO}_4^{2-}$  ions. In contrast  $[\text{Co}(\text{NH}_3)_5\text{SO}_4]\text{Br}$  is red. A solution of this complex does not give a positive sulphate test with  $\text{BaCl}_2$ . It does give a cream-coloured precipitate

of AgBr with AgNO<sub>3</sub>, thus confirming the presence of free Br<sup>-</sup> ions. Note that the sulphate ion occupies only one coordination position even though it has two negative charges. Other examples of ionization isomerism are [Pt(NH<sub>3</sub>)<sub>4</sub>Cl<sub>2</sub>]Br<sub>2</sub> and [Pt(NH<sub>3</sub>)<sub>4</sub>Br<sub>2</sub>]Cl<sub>2</sub>, and [Co(en)<sub>2</sub>NO<sub>2</sub>·Cl]SCN, [Co(en)<sub>2</sub>NO<sub>2</sub>·SCN]Cl and [Co(en)<sub>2</sub>Cl·SCN]NO<sub>2</sub>.

### Hydrate isomerism

Three isomers of CrCl<sub>3</sub>·6H<sub>2</sub>O are known. From conductivity measurements and quantitative precipitation of the ionized chlorine, they have been given the following formulae:

[Cr(H <sub>2</sub> O) <sub>6</sub> ]Cl <sub>3</sub>	violet	(three ionic chlorines)
[Cr(H <sub>2</sub> O) <sub>5</sub> Cl]Cl <sub>2</sub> ·H <sub>2</sub> O	green	(two ionic chlorines)
[Cr(H <sub>2</sub> O) <sub>4</sub> Cl <sub>2</sub> ]·Cl·2H <sub>2</sub> O	dark green	(one ionic chlorine)

### Linkage isomerism

Certain ligands contain more than one atom which could donate an electron pair. In the NO<sub>2</sub><sup>-</sup> ion, either N or O atoms could act as the electron pair donor. Thus there is the possibility of isomerism. Two different complexes [Co(NH<sub>3</sub>)<sub>5</sub>NO<sub>2</sub>]Cl<sub>2</sub> have been prepared, each containing the NO<sub>2</sub><sup>-</sup> easily decomposed by acids to give nitrous acid. It contains Co—ONO and is a nitrito complex. The other complex is yellow and is stable to acids. It contains the Co—NO<sub>2</sub> group and is a nitro compound. The two materials are represented in Figure 7.32. This type of isomerism also occurs with other ligands such as SCN<sup>-</sup>.

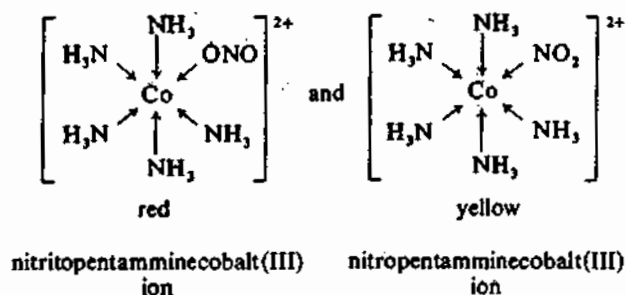

Figure 7.32: Nitrito and nitro complexes.

### Coordination isomerism

When both the positive and negative ions are complex ions, isomerism may be caused by the interchange of ligands between the anion and cation, for example [Co(NH<sub>3</sub>)<sub>6</sub>][Cr(CN)<sub>6</sub>] and [Cr(NH<sub>3</sub>)<sub>6</sub>][Co(CN)<sub>6</sub>]. Intermediate types between these extremes are also possible.

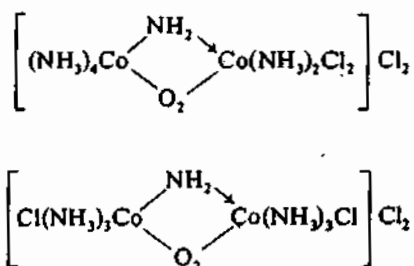

Figure 7.33 Coordination position isomers.

**Coordination position isomerism**

In polynuclear complexes an interchange of ligands between the different metal nuclei gives rise to positional isomerism. An example is given in Figure 7.33.

**Geometric isomerism or stereoisomerism**

In disubstituted complexes, the substituted groups may be adjacent or opposite to each other. This gives rise to geometric isomerism. Thus square planar complexes such as  $[\text{Pt}(\text{NH}_3)_2\text{Cl}_2]$  can be prepared in two forms, *cis* and *trans*. If the complex is prepared by adding  $\text{NH}_4\text{OH}$  to a solution of  $[\text{PtCl}_4]^{2-}$  ions, the complex has a finite dipole moment and must therefore be *cis*. The complex prepared by treating  $[\text{Pt}(\text{NH}_3)_4]^{2+}$  with  $\text{HCl}$  has no dipole, and must therefore be *trans*. The two complexes are shown in Figure 7.34. The same sort of isomerism can also occur in square planar chelate complexes if the chelating group is not symmetrical. An example of *cis-trans* isomerism is found in the complex between glycine and platinum (Figure 7.35).

In a similar way disubstituted octahedral complexes such as  $[\text{Co}(\text{NH}_3)_4\text{Cl}_2]^+$  exists in *cis* and *trans* forms (Figure 7.36). (This method of drawing an octahedral complex might suggest that the positions in the square are different from the up and down positions. This is not the case as all six positions are equivalent.)

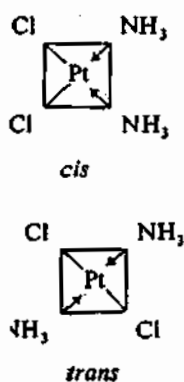
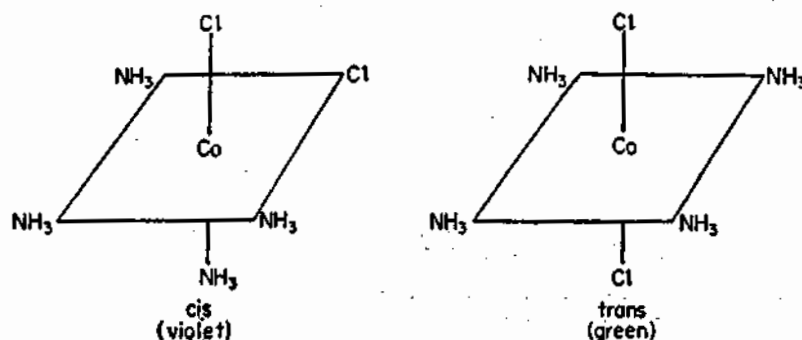
4 *Cis* and *trans*Figure 7.36 *Cis* and *trans* octahedral complexes.

## Optical isomerism

At one time it was thought that optical isomerism was associated only with carbon compounds. It exists in inorganic molecules as well. If a molecule is

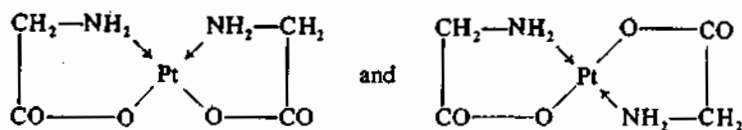

Figure 7.35 *Cis* and *trans* glycine complexes.

asymmetric, it cannot be superimposed on its mirror image. The two forms have the type of symmetry shown by the left and right hands and are called an enantiomorph pair. The two forms are optical isomers. They are called either *dextro* or *laevo* (often shortened to *d* or *l*). This depends on the direction they rotate the plane of polarized light in a polarimeter. (*d* rotates to the right, *l* to the left.) Optical isomerism is common in octahedral complexes involving bidentate groups. For example,  $[\text{Co}(\text{en})_2\text{Cl}_2]^+$

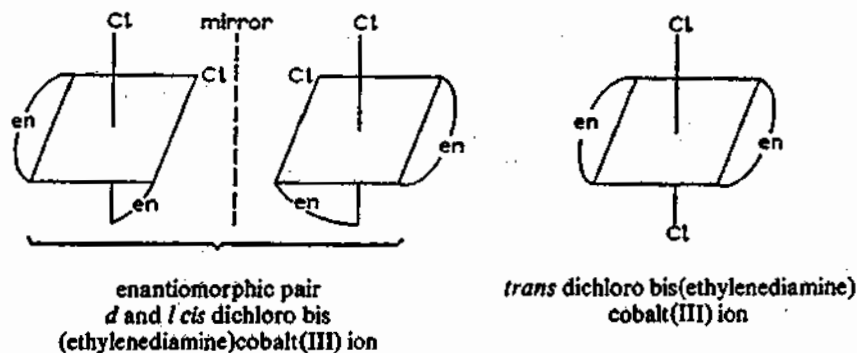

Figure 7.37 Isomers of  $[\text{Co}(\text{en})_2\text{Cl}_2]^+$ .

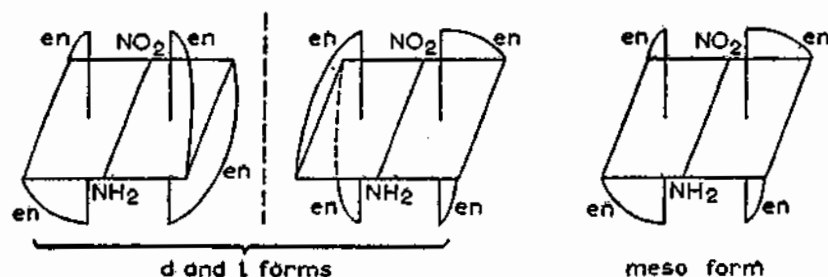

Figure 7.39 *d*, *l* and *meso* forms.

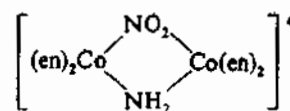

Figure 7.38

shows *cis* and *trans* forms (geometric isomerism). In addition the *cis* form is optically active and exists in *d* and *l* forms, making a total of three isomers (Figure 7.37). Optical activity occurs also in polynuclear complexes, such as that shown in Figure 7.38. This has been resolved into two optically active forms (*d* and *l*) and an optically inactive form which is internally compensated and is called the *meso* form (Figure 7.39).

#### FURTHER READING

- Ahrland, S., Chatt, J. and Davies, N.R. (1958) The relative affinities of ligand atoms for acceptor molecules and ions, *Q. Rev. Chem. Soc.*, **12**, 265–276.
- Bell, C.F. (1977) *Principles and Applications of Metal Chelation*, Oxford University Press, Oxford.
- Emeléus H.J. and Sharpe, A.G. (1973) *Modern Aspects of Inorganic Chemistry*, 4th ed. (Complexes of Transition Metals: Chapter 14, Structure; Chapter 15, Bonding; Chapter 16, Magnetic Properties; Chapter 17, Electronic Spectra), Routledge and Kegan Paul, London.
- Gerloch, M. (1981) The sense of Jahn–Teller distortions in octahedral copper(II) and other transition metal complexes, *Inorg. Chem.*, **20**, 638–640.
- Hogfeldt, E. (ed.) (1982) *Stability Constants of Metal-ion Complexes*, Pergamon, Oxford. (Inorganic ligands.)
- Johnson, B.F.G. (1973) *Comprehensive Inorganic Chemistry*, Vol. IV (Chapter 52: Transition metal chemistry), Pergamon Press, Oxford.
- Jørgensen, C.K. (1962) *Absorption Spectra and Chemical Bonding in Complexes* (Chapter 7) Pergamon Press, Oxford.
- Kauffman, G.B. (1966) *Alfred Werner Founder of Coordination Theory*, Springer, Berlin.
- Kauffman, G.B. (ed.) (1968, 1976, 1978) *Classics in Coordination Chemistry*, Part I, The Selected Papers of Alfred Werner; Part II, Selected Papers (1798–1899); Part III, Twentieth Century Papers. Dover, New York.
- Kauffman, G.B. (1973) Alfred Werner's research on structural isomerism, *Coord. Chem. Rev.*, **11**, 161–188.
- Kauffman, G.B. (1974) Alfred Werner's research on optically active coordination compounds, *Coord. Chem. Rev.*, **12**, 105–149.
- Martell, A.E. (ed.) (1971, 1978) *Coordination Chemistry*, Vol. I and II, Van Nostrand Reinhold, New York.
- Munro, D. (1977) Misunderstandings over the chelate effect, *Chemistry in Britain*, **13**, 100. (A simple article on the chelate effect.)
- Perrin, D. (ed.) (1979) *Stability Constants of Metal-ion Complexes*, Chemical Society, Pergamon. (Organic ligands.)
- Sillen, L.G. and Martell, A.E. (1964, 1971) *Stability Constants of Metal-ion Complexes* (Special Publications of the Chemical Society, no. 17 and no. 25), The Chemical Society, London.
- Tsuchida, R. (1938) Absorption spectra of coordination compounds, *Bull. Soc. Japan*, 1938, 388–400, 434–450 and 471–480.

#### PROBLEMS

1. List and explain the factors which affect the stability of coordination complexes.
2. Describe the methods by which the presence of complex ions may be detected in solution.

- Draw all of the isomers of an octahedral complex which has six unidentate ligands, two of type A and four of type B.
- Draw all of the isomers of an octahedral complex which has three unidentate ligands of type A and three unidentate ligands of type B.
- Draw all of the isomers of an octahedral complex which has three identical bidentate ligands.
- Draw all of the isomers of both tetrahedral and square planar complexes which have two unidentate ligands of type A and two unidentate ligands of type B.
- Draw each of the possible stereoisomers of the octahedral complexes listed: (a)  $Ma_3bcd$ , (b)  $Ma_2bcde$  and (c)  $M(AA)(AA)cd$ . The lower case letters a, b, c, d, and e represent monodentate ligands, and upper case letters (AA) represent the donor atoms of a bidentate ligand. Indicate which isomers are optically active (chiral).
- Draw the shapes of the various  $d$  orbitals, and explain why they are split into two groups  $t_{2g}$  and  $e_g$  in an octahedral ligand field.
- Draw a diagram to show how the  $d$  orbitals are split into groups with different energy in an octahedral ligand field. Some electronic configurations may exist in both high-spin and low-spin arrangements in an octahedral field. Draw all of these cases, and suggest which metal ions and which ligands might give rise to each.
- Draw an energy level diagram to show the lifting of the degeneracy of the  $3d$  orbitals in a tetrahedral ligand field.
- Draw energy level diagrams and indicate the occupancy of the orbitals in the following complexes:
  - $d^6$ , octahedral, low-spin
  - $d^9$ , octahedral with tetragonal elongation
  - $d^8$ , square planar
  - $d^6$ , tetrahedral.Calculate in units of  $\Delta_o$  the difference in crystal field stabilization energy between complexes (a) and (d) assuming that the ligands are strong field ligands.  
(Answer: octahedral  $-2.4\Delta_o$ , tetrahedral  $-0.27\Delta_o$ , difference  $-2.13\Delta_o$ .)
- Calculate the crystal field stabilization energy for a  $d^8$  ion such as  $Ni^{2+}$  in octahedral and tetrahedral complexes. Use units of  $\Delta_o$  in both cases. Which is the most stable? State any assumptions made.
- Calculate the spin only magnetic moment for a  $d^8$  ion in octahedral, square planar and tetrahedral ligand fields.
- Show by means of a diagram how the pattern of  $d$  orbital splitting changes as an octahedral complex undergoes tetragonal distortion and eventually becomes a square planar complex.

15. Why are  $d-d$  electronic transitions forbidden? Why are they weakly absorbing and why do they occur at all?
16. Why are compounds of  $Ti^{4+}$  and  $Zn^{2+}$  typically white? Why are  $Mn^{2+}$  compounds very pale in colour? What  $d-d$  transitions are spin allowed for a  $d^5$  ion?
17. What is the spectrochemical series, and what is its importance?
18. Given that the maximum absorption in the  $d-d$  peak for  $[Ti(H_2O)_6]^{3+}$  occurs at  $20300\text{ cm}^{-1}$ , predict where the peaks will occur for  $[Ti(CN)_6]^{3-}$  and  $[Ti(Cl)_6]^{3-}$ .
19. Describe how  $\Delta_o$  changes as the charge on the central metal changes from  $M^{2+}$  to  $M^{3+}$ , and how it changes in a vertical group or triad between a first row, second row or third row transition element.
20. What would you expect the crystal field stabilization energy to be, and what value of magnetic moment would you expect, for the following complexes: (a)  $[CoF_6]^{3-}$ , (b)  $[Co(NH_3)_6]^{3+}$ , (c)  $[Fe(H_2O)_6]^{2+}$ , (d)  $[Fe(CN)_6]^{4-}$  and (e)  $[Fe(CN)_6]^{3-}$ .
21. In the crystal structure of  $CuF_2$ , the  $Cu^{2+}$  is six-coordinate with four  $F^-$  at a distance of  $1.93\text{ \AA}$  and two  $F^-$  at  $2.27\text{ \AA}$ . Explain the reason for this.
22. Describe and explain the Jahn-Teller effect in octahedral complexes of  $Cr^{2+}$  and  $Cu^{2+}$ .
23. The complex  $[Ni(CN)_4]^{2-}$  is diamagnetic, but  $[NiCl_4]^{2-}$  is paramagnetic and has two unpaired electrons. Explain these observations and deduce the structures of the two complexes.
24. What methods could be used to distinguish between *cis* and *trans* isomers of a complex?
25. Name the individual isomers of each of the following:
  - (a)  $[Pt(NH_3)_2Cl_2]$
  - (b)  $CrCl_3 \cdot 6H_2O$
  - (c)  $[Co(NH_3)_5NO_2](NO_3)_2$
  - (d)  $Co(NH_3)_5(SO_4)(Cl)$
  - (e) 
$$\left[ \begin{array}{ccc} & NH_2 & \\ & | & \\ (en)_2Co & & Co(en)_2 \\ & | & \\ & NO_2 & \end{array} \right] Br_4$$
  - (f)  $Co(en)_2NH_3BrSO_4$
  - (g)  $[Pt(NH_3)(H_2O)(C_5H_5N)(NO_2)]Cl$ .
26. Account for the following:
  - (a)  $Ni(CO)_4$  is tetrahedral
  - (b)  $[Ni(CN)_4]^{2-}$  is square planar
  - (c)  $[Ni(NH_3)_6]^{2+}$  is octahedral.



27. What is the oxidation number of the metal in each of the following complexes:
- $[\text{Co}(\text{NH}_3)_6]\text{Cl}_3$
  - $[\text{CoSO}_4(\text{NH}_3)_4]\text{NO}_3$
  - $[\text{Cd}(\text{SCN})_4]^{2+}$
  - $[\text{Cr}(\text{en})_3]\text{Cl}_3$
  - $[\text{CuCl}_2(\text{CH}_3\text{NH}_2)_2]$
  - $[\text{AlH}_4]^-$
  - $[\text{Fe}(\text{CN})_6]^{4-}$
  - $[\text{OsCl}_5\text{N}]^{2-}$
  - $[\text{Ag}(\text{S}_2\text{O}_3)_2]^{3-}$
28. Write the formula for each of the following complexes:
- hexamminecobalt(III) chloride
  - potassium iron(III) hexacyanoferrate(II)
  - diamminedichloroplatinum(II)
  - tetracarbonylnickel(0)
  - triamminechlorocyanonitrocobalt(III)
  - lithium tetrahydridoaluminate(III)
  - sodium bis(thiosulphato)argentate(I)
  - nickel hexachloroplatinate(IV)
  - tetraammineplatinum(II) amminetrichloroplatinate(II)
29. Write the formula for each of the following complexes:
- tetraamminecopper(II) sulphate
  - potassium tetracyanonickelate(0)
  - bis(cyclopentadienyl)iron(II)
  - tetrathiocyanato-N-zinc(II)
  - diamminebis(ethylenediamine)cobalt(III) chloride
  - tetraamminedithiocyanatochromium(III)
  - potassium tetraoxomanganate(VII)
  - potassium trioxalatoaluminate(III)
  - tetrapyridineplatinum(II) tetrachloroplatinate(II)

# 8

## Hydrogen and the hydrides

### ELECTRONIC STRUCTURE

Hydrogen has the simplest atomic structure of all the elements, and consists of a nucleus containing one proton with a charge +1 and one orbital electron. The electronic structure may be written as  $1s^1$ . Atoms of hydrogen may attain stability in three different ways:

1. *By forming an electron pair (covalent) bond with another atom*  
Non-metals typically form this type of bond with hydrogen, for example  $H_2$ ,  $H_2O$ ,  $HCl_{(gas)}$  or  $CH_4$ , and many metals do so too.
2. *By losing an electron to form  $H^+$*   
A proton is extremely small (radius approximately  $1.5 \times 10^{-5} \text{ \AA}$ , compared with  $0.7414 \text{ \AA}$  for hydrogen, and  $1-2 \text{ \AA}$  for most atoms). Because  $H^+$  is so small, it has a very high polarizing power, and therefore distorts the electron cloud on other atoms. Thus protons are always associated with other atoms or molecules. For example, in water or aqueous solutions of  $HCl$  and  $H_2SO_4$ , protons exist as  $H_3O^+$ ,  $H_9O_4^+$  or  $H(H_2O)_n^+$  ions. Free protons do not exist under 'normal conditions', though they are found in low pressure gaseous beams, for example in a mass spectrometer.
3. *By gaining an electron to form  $H^-$*   
Crystalline solids such as  $LiH$  contain the  $H^-$  ion and are formed by highly electropositive metals (all of Group I, and some of Group II). However,  $H^-$  ions are uncommon.

Since hydrogen has an electronegativity of 2.1, it may use any of the three methods, but the most common way is forming covalent bonds.

### POSITION IN THE PERIODIC TABLE

Hydrogen is the first element in the periodic table, and is unique. There are only two elements in the first period, hydrogen and helium. Hydrogen is quite reactive, but helium is inert. There is no difficulty relating the structure and properties of helium to those of the other noble gases in

Group 0, but the properties of hydrogen cannot be correlated with any of the main groups in the periodic table, and hydrogen is best considered on its own.

The structure of hydrogen atoms is in some ways like that of the alkali metals. The alkali metals (Group I) also have just one electron in their outer shell, but they tend to lose this electron in reactions and form positive ions  $M^+$ . Though  $H^+$  are known, hydrogen has a much greater tendency to pair the electron and form a covalent bond.

The structure of hydrogen atoms is in some ways like that of the halogens (Group VII), since both are one electron short of a noble gas structure. In many reactions the halogens gain an electron and so form negative ions  $X^-$ . Hydrogen does not typically form a negative ion, although it does form ionic hydrides  $M^+H^-$  (e.g.  $LiH$  and  $CaH_2$ ) with a few highly electro-positive metals.

In some ways the structure of hydrogen resembles that of the Group IV elements, since both have a half filled shell of electrons. There are a number of similarities between hydrides and organometallic compounds since the groups  $CH_3-$  and  $H-$  both have one remaining valency. Thus the hydride is often considered as part of a series of organometallic compounds, for example  $LiH$ ,  $LiMe$ ,  $LiEt$ ;  $NH_3$ ,  $NMe_3$ ,  $NEt_3$ ; or  $SiH_4$ ,  $CH_3SiH_3$ ,  $(CH_3)_2SiCl_2$ ,  $(CH_3)_3SiCl$ ,  $(CH_3)_4Si$ . However, hydrogen is best treated as a group on its own.

#### ABUNDANCE OF HYDROGEN

Hydrogen is the most abundant element in the universe. Some estimates are that 92% of the universe is made up of hydrogen, and 7% helium, leaving only 1% for all of the other elements. However, the abundance of  $H_2$  in the earth's atmosphere is very small. This is because the earth's gravitational field is too small to hold so light an element, though some  $H_2$  is found in volcano gases. In contrast, hydrogen is the tenth most abundant element in the earth's crust (1520 ppm or 0.152% by weight). It also occurs in vast quantities as water in the oceans. Compounds containing hydrogen are very abundant, particularly water, living matter (carbohydrates and proteins), organic compounds, fossil fuels (coal, petroleum, and natural gas), ammonia and acids. In fact hydrogen is present in more compounds than any other element.

#### PREPARATION OF HYDROGEN

Hydrogen is manufactured on a large scale by a variety of methods:

1. Hydrogen is made cheaply, and in large amounts, by passing steam over red hot coke. The product is water gas, which is a mixture of  $CO$  and  $H_2$ . This is an important industrial fuel since it is easy to make and it burns, evolving a lot of heat.

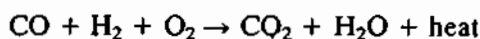
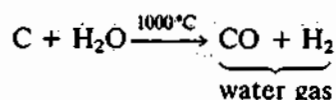

It is difficult to obtain pure  $\text{H}_2$  from water gas, since  $\text{CO}$  is difficult to remove. The  $\text{CO}$  may be liquified at a low temperature under pressure, thus separating it from  $\text{H}_2$ . Alternatively the gas mixture can be mixed with steam, cooled to  $400^\circ\text{C}$  and passed over iron oxide in a shift converter, giving  $\text{H}_2$  and  $\text{CO}_2$ . The  $\text{CO}_2$  so formed is easily removed either by dissolving in water under pressure, or reacting with  $\text{K}_2\text{CO}_3$  solution, giving  $\text{KHCO}_3$ , and thus giving  $\text{H}_2$  gas.

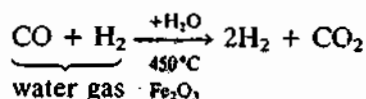

2. Hydrogen is also made in large amounts by the steam reformer process. The hydrogen produced in this way is used in the Haber process to make  $\text{NH}_3$ , and for hardening oils. Light hydrocarbons such as methane are mixed with steam and passed over a nickel catalyst at  $800\text{--}900^\circ\text{C}$ . These hydrocarbons are present in natural gas, and are also produced at oil refineries when 'cracking' hydrocarbons.

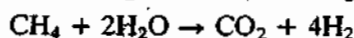
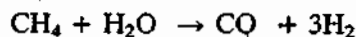

The gas emerging from the reformer contains  $\text{CO}$ ,  $\text{CO}_2$ ,  $\text{H}_2$  and excess steam. The gas mixture is mixed with more steam, cooled to  $400^\circ\text{C}$  and passed into a shift converter. This contains an iron/copper catalyst and  $\text{CO}$  is converted into  $\text{CO}_2$ .

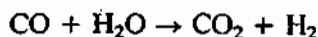

Finally the  $\text{CO}_2$  is absorbed in a solution of  $\text{K}_2\text{CO}_3$  or ethanolamine  $\text{HOCH}_2\text{CH}_2\text{NH}_2$ . The  $\text{K}_2\text{CO}_3$  or ethanolamine are regenerated by heating.

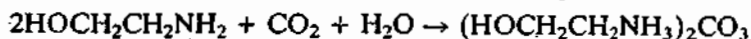
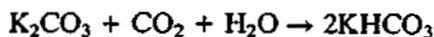

3. In oil refineries, natural hydrocarbon mixtures of high molecular weight such as naphtha and fuel oil are 'cracked' to produce lower molecular weight hydrocarbons which can be used as petrol. Hydrogen is a valuable by-product.
4. Very pure hydrogen (99.9% pure) is made by electrolysis of water or solutions of  $\text{NaOH}$  or  $\text{KOH}$ . This is the most expensive method. Water does not conduct electricity very well, so it is usual to electrolyse aqueous solutions of  $\text{NaOH}$  or  $\text{KOH}$  in a cell with nickel anodes and

iron cathodes. The gases produced in the anode and cathode compartments must be kept separate.

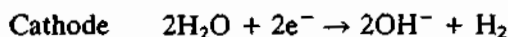

5. A large amount of pure hydrogen is also formed as a by-product from the chlor-alkali industry, in which aqueous NaCl is electrolysed to produce NaOH, Cl<sub>2</sub> and H<sub>2</sub>.
6. The usual laboratory preparation is the reaction of dilute acids with metals, or of an alkali with aluminium.

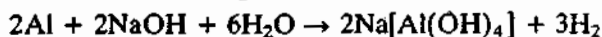
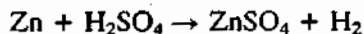

7. Hydrogen can be prepared by the reaction of salt-like hydrides with water.

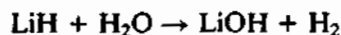

### PROPERTIES OF MOLECULAR HYDROGEN

Hydrogen is the lightest gas known, and because of its low density, it is used instead of helium to fill balloons for meteorology. It is colourless, odourless and almost insoluble in water. Hydrogen forms diatomic molecules H<sub>2</sub>, and the two atoms are joined by a very strong covalent bond (bond energy 435.9 kJ mol<sup>-1</sup>).

Hydrogen is not very reactive under normal conditions. The lack of reactivity is due to kinetics rather than thermodynamics, and relates to the strength of the H—H bond. An essential step in H<sub>2</sub> reacting with another element is the breaking of the H—H bond to produce atoms of hydrogen. This requires 435.9 kJ mol<sup>-1</sup>; hence there is a high activation energy to such reactions. Consequently many reactions are slow, or require high temperatures, or catalysts (often transition metals). Many important reactions of hydrogen involve heterogeneous catalysis, where the catalyst first reacts with H<sub>2</sub> and either breaks or weakens the H—H bond, and thus lowers the activation energy. Examples include:

1. The Haber process for the manufacture of NH<sub>3</sub> from N<sub>2</sub> and H<sub>2</sub> using a catalyst of activated Fe at 380–450°C and 200 atmospheres pressure.
2. The hydrogenation of a variety of unsaturated organic compounds, (including the hardening of oils), using finely divided Ni, Pd or Pt as catalysts.
3. The production of methanol by reducing CO with H<sub>2</sub> over a Cu/Zn catalyst at 300°C.

Thus hydrogen will react directly with most elements *under the appropriate conditions*.

Hydrogen burns in air or oxygen, forming water, and liberates a large amount of energy. This is used in the oxy-hydrogen flame for welding and cutting metals. Temperatures of almost 3000°C can be attained. Care should be taken with these gases since mixtures of H<sub>2</sub> and O<sub>2</sub> close to a 2:1 ratio are often explosive.



Hydrogen reacts with the halogens. The reaction with fluorine is violent, even at low temperatures. The reaction with chlorine is slow in the dark, but the reaction is catalysed by light (photocatalysis), and becomes faster in daylight, and explosive in sunlight. Direct combination of the elements is used to produce HCl.

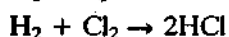
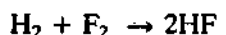

A number of metals react with H<sub>2</sub>, forming hydrides. The reactions are not violent, and usually require a high temperature. These are described in a later section.

Large quantities of H<sub>2</sub> are used in the industrial production of ammonia by the Haber process. The reaction is reversible, and the formation of NH<sub>3</sub> is favoured by high pressure, the presence of a catalyst (Fe), and a low temperature. In practice a high temperature of 380–450°C and a pressure of 200 atmospheres are used to get a reasonable conversion in a reasonable time.



Large amounts of H<sub>2</sub> are used for hydrogenation reactions, in which hydrogen is added to a double bond in an organic compound. An important example is the hardening of fats and oils. Unsaturated fatty acids are hydrogenated with H<sub>2</sub> and a palladium catalyst, forming saturated fatty acids which have higher melting points. By removing double bonds in the carbon chain in this way, edible oils which are liquid at room temperature may be converted into fats which are solid at room temperature. The reason for doing this is that solid fats are more useful than oils, for example in the manufacture of margarine.

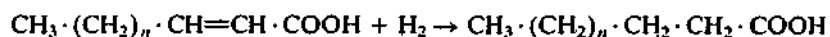

Hydrogen is also used to reduce nitrobenzene to aniline (dyestuffs industry), and in the catalytic reduction of benzene (the first step in the production of nylon-66). It also reacts with CO to form methyl alcohol.

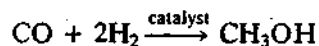

The hydrogen molecule is very stable, and has little tendency to dissociate at normal temperatures, since the dissociation reaction is highly endothermic.

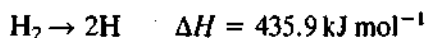

However, at high temperatures, in an electric arc, or under ultraviolet light,  $H_2$  does dissociate. The atomic hydrogen produced exists for less than half a second, after which it recombines to give molecular hydrogen and a large amount of heat. This reaction has been used in welding metals. Atomic hydrogen is a strong reducing agent, and is commonly prepared in solution by means of a zinc-copper couple or a mercury-aluminium couple.

There has been much talk of *the hydrogen economy*. (See Further Reading.) The idea is that hydrogen could replace coal and oil as the major source of energy. Burning hydrogen in air or oxygen forms water and liberates a great deal of energy. In contrast to burning coal or oil in power stations, or petrol or diesel fuel in motor engines, burning hydrogen produces no pollutants like  $SO_2$  and oxides of nitrogen that are responsible for acid rain, nor  $CO_2$  that is responsible for the greenhouse effect, nor carcinogenic hydrocarbons, nor lead compounds. Hydrogen can be produced readily by electrolysis, and chemical methods. Hydrogen can be stored and transported as gas in cylinders, as liquid in very large cryogenic vacuum flasks, or 'dissolved' in various metals. (For example, the alloy  $LaNi_5$  can absorb seven moles of hydrogen per mole of alloy at 2.5 atmospheres pressure and room temperature.) Liquid hydrogen is used as a fuel in space rockets for the Saturn series and the space shuttle in the US space programme. Car engines have been modified to run on hydrogen. Note that the use of hydrogen involves the risk of an explosion, but so does the use of petrol.

## ISOTOPES OF HYDROGEN

If atoms of the same element have different mass numbers they are called isotopes. The difference in mass number arises because the nucleus contains a different number of neutrons. Naturally occurring hydrogen contains three isotopes: protium  ${}^1_1H$  or H, deuterium  ${}^2_1H$  or D, and tritium  ${}^3_1H$  or T. Each of the three isotopes contains one proton and 0, 1 or 2 neutrons respectively in the nucleus. Protium is by far the most abundant.

Naturally occurring hydrogen contains 99.986% of the  ${}^1_1H$  isotope, 0.014% of  ${}^2_1D$  and  $7 \times 10^{-16}\%$   ${}^3_1T$ , so the properties of hydrogen are essentially those of the lightest isotope.

These isotopes have the same electronic configuration and have essentially the same chemical properties. The only differences in chemical properties are the rates of reactions, and equilibrium constants. For example:

1.  $H_2$  is more rapidly adsorbed on to surfaces than  $D_2$ .
2.  $H_2$  reacts over 13 times faster with  $Cl_2$  than  $D_2$ , because  $H_2$  has a lower energy of activation.

Differences in properties which arise from differences in mass are called *isotope effects*. Because hydrogen is so light, the percentage difference in mass between protium  ${}^1_1H$ , deuterium  ${}^2_1H$  and tritium  ${}^3_1H$  is greater than

Table 8.1 Physical constants for hydrogen, deuterium and tritium

Physical constant	H <sub>2</sub>	D <sub>2</sub>	T <sub>2</sub>
Mass of atom (amu)	1.0078	2.0141	3.0160
Freezing point (°C)	-259.0	-254.3	-252.4
Boiling point (°C)	-252.6	-249.3	-248.0
Bond length (Å)	0.7414	0.7414	(0.7414)
Heat of dissociation <sup>†</sup> (kJ mol <sup>-1</sup> )	435.9	443.4	446.9
Latent heat of fusion (kJ mol <sup>-1</sup> )	0.117	0.197	0.250
Latent heat of vaporisation (kJ mol <sup>-1</sup> )	0.904	1.226	1.393
Vapour pressure* (mm Hg)	54	5.8	-

\* Measured at -259.1°C.

† Measured at 25°C.

between the isotopes of any other element. Thus the isotopes of hydrogen show much greater differences in physical properties than are found between the isotopes of other elements. Some physical constants for H<sub>2</sub>, D<sub>2</sub> and T<sub>2</sub> are given in Table 8.1.

Protium water H<sub>2</sub>O dissociates to about three times the extent that heavy water D<sub>2</sub>O does. The equilibrium constant for the dissociation of H<sub>2</sub>O is  $1.0 \times 10^{-14}$  whilst for D<sub>2</sub>O it is  $3.0 \times 10^{-15}$ .

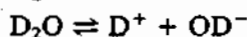
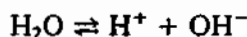

Protium bonds are broken more readily than deuterium bonds (up to 18 times more readily in some cases). Thus when water is electrolysed, H<sub>2</sub> is liberated much faster than D<sub>2</sub>, and the remaining water thus becomes enriched in heavy water D<sub>2</sub>O. If the process is continued until only a small volume remains, then almost pure D<sub>2</sub>O is obtained. About 29 000 litres of water must be electrolysed to give 1 litre of D<sub>2</sub>O that is 99% pure. This is the normal way of separating deuterium. Heavy water D<sub>2</sub>O undergoes all of the reactions of ordinary water, and is useful in the preparation of other deuterium compounds. Because D<sub>2</sub>O has a lower dielectric constant, ionic

Table 8.2 Physical constants for water and heavy water

Physical constant	H <sub>2</sub> O	D <sub>2</sub> O
Freezing point (°C)	0	3.82
Boiling point (°C)	100	101.42
Density at 20°C (g cm <sup>-3</sup> )	0.917	1.017
Temperature of maximum density (°C)	4	11.6
Ionic product K <sub>w</sub> at 25°C	$1.0 \times 10^{-14}$	$3.0 \times 10^{-15}$
Dielectric constant at 20°C	82	80.5
Solubility g NaCl/100 g water at 25°C	35.9	30.5
Solubility g BaCl <sub>2</sub> /100 g water at 25°C	35.7	28.9



compounds are less soluble in it than in water. Some physical properties of  $H_2O$  and  $D_2O$  are compared in Table 8.2.

Deuterium compounds are commonly prepared by 'exchange' reactions where under suitable conditions deuterium is exchanged for hydrogen in compounds. Thus  $D_2$  reacts with  $H_2$  at high temperatures, forming  $HD$ , and it also exchanges with  $NH_3$  and  $CH_4$  to give  $NH_2D$ ,  $NHD_2$ ,  $ND_3$  and  $CH_3D-CD_4$ . It is usually easier to prepare deuterated compounds using  $D_2O$  rather than  $D_2$ . The  $D_2O$  may be used directly in the preparation instead of  $H_2O$ , or exchange reactions may be carried out using  $D_2O$ .

*Exchange reactions*

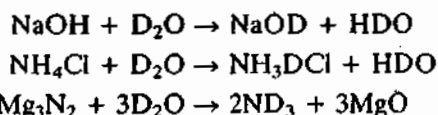

*Direct reactions*

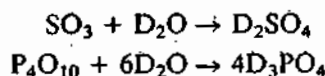

Tritium is radioactive and decays by  $\beta$  emission.



It has a relatively short half life time of 12.26 years. Thus any T present when the earth was formed has decayed already, and the small amount now present has been formed recently by reactions induced by cosmic rays in the upper atmosphere.

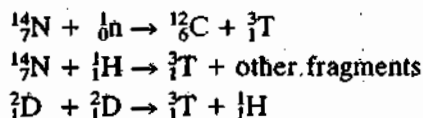

Tritium only occurs to the extent of one part  $T_2$  to  $7 \times 10^{17}$  parts  $H_2$ . It was first made by bombarding  $D_3PO_4$  and  $(ND_4)_2SO_4$  with deuterons  $D^+$ .

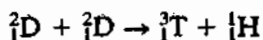

It is now produced on a large scale by irradiating lithium with slow neutrons in a nuclear reactor.

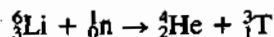

Tritium is used to make thermonuclear devices, and for research into fusion reactions as a means of producing energy. The gas is usually stored by making  $UT_3$ , which on heating to  $400^\circ C$  releases  $T_2$ . Tritium is widely used as a radioactive tracer, since it is relatively cheap, and it is easy to work with. It only emits low energy  $\beta$  radiation, with no  $\gamma$  radiation. The  $\beta$  radiation is stopped by 0.6 cm of air, so no shielding is required. It is non-toxic, except if labelled compounds are swallowed.

Tritiated compounds are made from  $T_2$  gas.  $T_2O$  is made as follows:

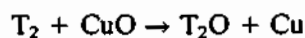

or

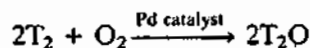

Many tritiated organic compounds can be made by storing the compound under  $\text{T}_2$  gas for a few weeks, when exchange of H and T occurs. Many compounds can be made by catalytic exchange in solution using either  $\text{T}_2$  gas dissolved in the water, or  $\text{T}_2\text{O}$ .

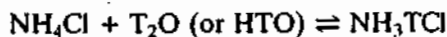

### ORTHO AND PARA HYDROGEN

The hydrogen molecule  $\text{H}_2$  exists in two different forms known as *ortho* and *para* hydrogen. The nucleus of an atom has nuclear spin, in a similar way to electrons having a spin. In the  $\text{H}_2$  molecule, the two nuclei may be spinning in either the same direction, or in opposite directions. This gives rise to spin isomerism, that is two different forms of  $\text{H}_2$  may exist. These are called *ortho* and *para* hydrogen. Spin isomerism is also found in other symmetrical molecules whose nuclei have spin momenta, e.g.  $\text{D}_2$ ,  $\text{N}_2$ ,  $\text{F}_2$ ,  $\text{Cl}_2$ . There are considerable differences between the physical properties (e.g. boiling points, specific heats and thermal conductivities) of the *ortho* and *para* forms, because of differences in their internal energy. There are also differences in the band spectra of the *ortho* and *para* forms of  $\text{H}_2$ .

The *para* form has the lower energy, and at absolute zero the gas contains 100% of the *para* form. As the temperature is raised, some of the *para* form changes into the *ortho* form. At high temperatures the gas contains about 75% *ortho* hydrogen.

*Para* hydrogen is usually prepared by passing a mixture of the two forms of hydrogen through a tube packed with charcoal cooled to liquid air temperature. *Para* hydrogen prepared in this way can be kept for weeks at room temperature in a glass vessel, because the *ortho-para* conversion is slow in the absence of catalysts. Suitable catalysts include activated charcoal, atomic hydrogen, metals such as Fe, Ni, Pt and W and paramagnetic substances or ions (which contain unpaired electrons) such as  $\text{O}_2$ , NO,  $\text{NO}_2$ ,  $\text{Co}^{2+}$  and  $\text{Cr}_2\text{O}_3$ .



(a)



(b)

1. *Ortho* and *para*  
n: (a) *ortho*, parallel  
) *para*, opposite.

### HYDRIDES

Binary compounds of the elements with hydrogen are called hydrides. The type of hydride which an element forms depends on its electronegativity, and hence on the type of bond formed. Whilst there is not a sharp division between ionic, covalent and metallic bonding, it is convenient to consider hydrides in three classes (Figure 8.2):

1. ionic or salt-like hydrides
2. covalent or molecular hydrides
3. metallic or interstitial hydrides

		s block		Intermediate Hydrides										p block					
Group	Period	I	II											III	IV	V	VI	VII	
	1																		
	2	<sup>3</sup> Li																	
	3	<sup>11</sup> Na																	
	4	<sup>19</sup> K	<sup>20</sup> Ca	d block															
	4	<sup>19</sup> K	<sup>20</sup> Ca	<sup>21</sup> Sc	<sup>22</sup> Ti	<sup>23</sup> V	<sup>24</sup> Cr						<sup>26</sup> Ni						
	5	<sup>37</sup> Rb	<sup>38</sup> Sr	<sup>39</sup> Y	<sup>40</sup> Zr	<sup>41</sup> Nb							<sup>46</sup> Pd						
	6	<sup>55</sup> Cs	<sup>56</sup> Ba	<sup>57</sup> La	<sup>72</sup> Hf	<sup>73</sup> Ta													
	7	<sup>87</sup> Fr	<sup>88</sup> Ra	<sup>89</sup> Ac										Covalent Hydrides					
Ionic Hydrides				f block															
Lanthanides				<sup>58</sup> Ce	<sup>59</sup> Pr	<sup>60</sup> Nd		<sup>62</sup> Sm	<sup>63</sup> Eu	<sup>64</sup> Gd	<sup>65</sup> Tb	<sup>66</sup> Dy	<sup>67</sup> Ho	<sup>68</sup> Er	<sup>69</sup> Tm	<sup>70</sup> Yb	<sup>71</sup> Lu		
Actinides				<sup>90</sup> Th	<sup>91</sup> Pa	<sup>92</sup> U	<sup>93</sup> Np	<sup>94</sup> Pu	<sup>95</sup> Am										

Figure 8.2 Types of hydride and the periodic table.

### Ionic or salt-like hydrides

At high temperatures the metals of Group I (alkali metals) and the heavier Group II metals (alkaline earth metals) Ca, Sr and Ba form ionic hydrides such as NaH and CaH<sub>2</sub>. These compounds are solids with high melting points, and are classified as ionic (salt-like) hydrides. The evidence that they are ionic is:

1. Molten LiH (m.p. 691°C) conducts electricity, and H<sub>2</sub> is liberated at the anode, thus confirming the presence of the hydride ion H<sup>-</sup>.
2. The other ionic hydrides decompose before melting, but they may be dissolved in melts of alkali halides (e.g. CaH<sub>2</sub> dissolves in a eutectic mixture of LiCl/KCl), and when the melt is electrolysed then H<sub>2</sub> is evolved at the anode.
3. The crystal structures of these hydrides are known, and they show no evidence of directional bonding.

Lithium is more polarizing and hence more likely to form covalent compounds than the other metals. Thus if LiH is largely ionic, the others must be ionic, and thus contain the hydride ion H<sup>-</sup>.

The density of these hydrides is greater than that of the metal from which they were formed. This is explained by H<sup>-</sup> ions occupying holes in the lattice of the metal, without distorting the metal lattice. Ionic hydrides have high heats of formation, and are always stoichiometric.

This type of hydride is only formed by elements with an electronega-

tivity value appreciably lower than the value of 2.1 for hydrogen, thus allowing the hydrogen to attract an electron from the metal, forming  $M^+$  and  $H^-$ .

Group I hydrides are more reactive than the corresponding Group II hydrides, and reactivity increases down the group.

Except for LiH, ionic hydrides decompose into their constituent elements on strong heating (400–500°C).

The hydride ion  $H^-$  is not very common, and it is unstable in water. Thus ionic hydrides all react with water and liberate hydrogen.

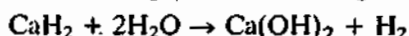
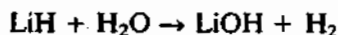

They are powerful reducing agents, especially at high temperatures, though their reactivity towards water limits their usefulness.

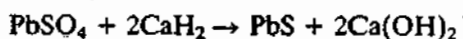
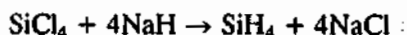
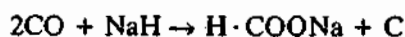

NaH has a number of uses as a reducing agent in synthetic chemistry. It is used to produce other important hydrides, particularly lithium aluminium hydride  $Li[AlH_4]$  and sodium borohydride  $Na[BH_4]$ , which have important uses as reducing agents in both organic and inorganic syntheses.

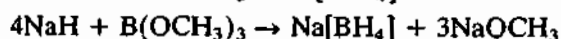

### Covalent hydrides

Hydrides of the *p*-block elements are covalent. This would be expected since there is only a small difference in electronegativity between these atoms and hydrogen. The compounds usually consist of discrete covalent molecules, with only weak van der Waals forces holding the molecules together, and so they are usually volatile, and have low melting and boiling points. They do not conduct electricity. The formula of these hydrides is  $XH_n$  or  $XH_{(8-n)}$  where *n* is the group in the periodic table to which X belongs. These hydrides are produced by a variety of synthetic methods:

1. A few may be made by direct action.

Group	III	IV	V	VI	VII
	B	C	N	O	F
	Al	Si	P	S	Cl
	Ga	Ge	As	Se	Br
	In	Sn	Sb	Te	I
		Pb	Bi	Po	

Figure 8.3 Covalent hydrides: .....

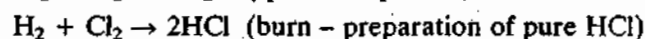
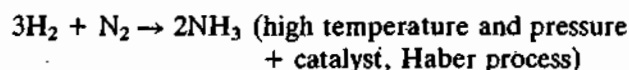

2. Reaction of a halide with  $\text{Li}[\text{AlH}_4]$  in a dry solvent such as ether.

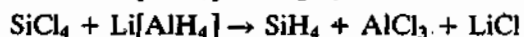
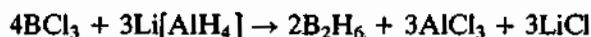

3. Treating the appropriate binary compound with acid.

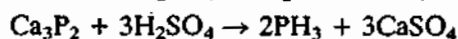
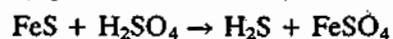
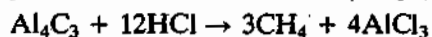

4. Reaction of an oxoacid with  $\text{Na}[\text{BH}_4]$  in aqueous solution.



5. Converting one hydride into another by pyrolysis (heating).

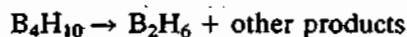

6. A silent electric discharge or microwave discharge may produce long chains from simple hydrides.

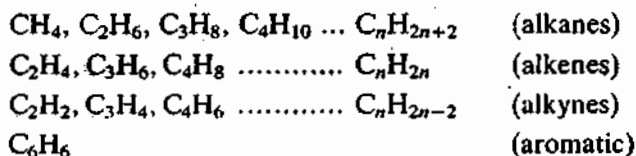

Table 8.3 Melting and boiling points of some covalent hydrides

Compound	m.p. (°C)	b.p. (°C)
$\text{B}_2\text{H}_6$	-165	-90
$\text{CH}_4$	-183	-162
$\text{SiH}_4$	-185	-111
$\text{GeH}_4$	-166	-88
$\text{SnH}_4$	-150	-52
$\text{NH}_3$	-78	-33
$\text{PH}_3$	-134	-88
$\text{AsH}_3$	-117	-62
$\text{SbH}_3$	-88	-18
$\text{H}_2\text{O}$	0	+100
$\text{H}_2\text{S}$	-86	-60
$\text{HF}$	-83	+20
$\text{HCl}$	-115	-84
$\text{HBr}$	-89	-67
$\text{HI}$	-51	-35

The Group III hydrides are unusual in that they are electron deficient and polymeric, although they do not contain direct bonds between the Group III elements. The simplest boron hydride is called diborane  $B_2H_6$ , though more complicated structures such as  $B_4H_{10}$ ,  $B_5H_9$ ,  $B_5H_{11}$ ,  $B_6H_{10}$  and  $B_{10}H_{14}$  are known. Aluminium hydride is polymeric  $(AlH_3)_n$ . In these structures, hydrogen appears to be bonded to two or more atoms, and this is explained in terms of multi-centre bonding. This is discussed in Chapter 12.

In addition to the simple hydrides, the rest of the lighter elements except the halogens form polynuclear hydrides. The tendency to do this is strongest with the elements C, N and O, and two or more of the non-metal atoms are directly bonded to each other. The tendency is greatest with C which catenates (forms chains) of several hundreds of atoms. These are grouped into three homologous series of aliphatic hydrocarbons, and aromatic hydrocarbons based on benzene.



The alkanes are saturated, but alkenes have double bonds, and alkynes have triple bonds. Si and Ge only form saturated compounds, and the maximum chain length is  $Si_{10}H_{22}$ . The longest hydride chains formed by other elements are  $Sn_2H_6$ ,  $N_2H_4$  and  $HN_3$ ,  $P_3H_5$ ,  $As_3H_5$ ,  $H_2O_2$  and  $H_2O_3$ , and  $H_2S_2$ ,  $H_2S_3$ ,  $H_2S_4$ ,  $H_2S_5$  and  $H_2S_6$ .

The melting point and boiling point of water stand out in Table 8.3 as being much higher than the others, but on closer examination the values for  $NH_3$  and  $HF$  also seem higher than would be expected in their respective groups. This is due to hydrogen bonding, which is discussed later in this chapter.

#### Metallic (or interstitial) hydrides

Many of the elements in the *d*-block, and the lanthanide and actinide elements in the *f*-block, react with  $H_2$  and form metallic hydrides. However, the elements in the middle of the *d*-block do not form hydrides. The absence of hydrides in this part of the periodic table is sometimes called *the hydrogen gap*. (See Figure 8.2.)

Metallic hydrides are usually prepared by heating the metal with hydrogen under high pressure. (If heated to higher temperatures the hydrides decompose, and this may be used as a convenient method of making very pure hydrogen.)

These hydrides generally have properties similar to those of the parent metals: they are hard, have a metallic lustre, conduct electricity, and have magnetic properties. The hydrides are less dense than the parent metal, because the crystal lattice has expanded through the inclusion of hydrogen.

This distortion of the crystal lattice may make the hydride brittle. Thus when the hydride is formed a solid piece of metal turns into finely powdered hydride. If the finely powdered hydrides are heated they decompose, giving hydrogen and very finely divided metal. These finely divided metals may be used as catalysts. They are also used in metallurgy in powder fabrication, and zirconium hydride has been used as a moderator in nuclear reactors.

In many cases the compounds are nonstoichiometric, for example  $\text{LaH}_n$ ,  $\text{TiH}_n$  and  $\text{PdH}_n$ , where the chemical composition is variable. Typical formulae are  $\text{LaH}_{2.87}$ ,  $\text{YbH}_{2.55}$ ,  $\text{TiH}_{1.8}$ ,  $\text{ZrH}_{1.9}$ ,  $\text{VH}_{1.6}$ ,  $\text{NbH}_{0.7}$  and  $\text{PdH}_{0.7}$ . Such compounds were originally called *interstitial hydrides*, and it was thought that a varying number of interstitial positions in the metal lattice could be filled by hydrogen.

The nonstoichiometric compounds may be regarded as solid solutions. Metals which can 'dissolve' varying amounts of hydrogen in this way can act as catalysts for hydrogenation reactions. The catalysts are thought to be effective through providing H atoms rather than  $\text{H}_2$  molecules. It is not certain whether the hydrogen is present in the interstitial sites as atoms of hydrogen, or alternatively as  $\text{H}^+$  ions with delocalized electrons, but they have strongly reducing properties.

Even small amounts of hydrogen dissolved in a metal adversely affect its strength and make it brittle. Titanium is extracted by reducing  $\text{TiCl}_4$  with Mg or Na in an inert atmosphere. If an atmosphere of  $\text{H}_2$  is used, the Ti dissolves  $\text{H}_2$ , and is brittle. Titanium is used to make supersonic aircraft, and since strength is important, it is produced in an atmosphere of argon.

The bonding is more complicated than was originally thought, and is still the subject of controversy.

1. Many of the hydrides have structures where hydrogen atoms occupy tetrahedral holes in a cubic close-packed array of metal atoms. If all of the tetrahedral sites are occupied then the formula is  $\text{MH}_2$ , and a fluorite structure is formed. Generally some sites are unoccupied, and hence the compounds contain less hydrogen. This accounts for the compounds of formula  $\text{MH}_{1.5-2}$  formed by the scandium and titanium groups, and most of the lanthanides and actinides.
2. Two of the lanthanide elements, europium and ytterbium, are unusual in that they form ionic hydrides  $\text{EuH}_2$  and  $\text{YbH}_2$ , which are stoichiometric and resemble  $\text{CaH}_2$ . The lanthanides are typically trivalent, but Eu and Yb form divalent ions (associated with stable electronic structures  $\text{Eu}(+II) 4f^7$  (half filled  $f$  shell), and  $\text{Yb}(+II) 4f^{14}$  (filled  $f$  shell)).
3. The compounds  $\text{YH}_2$  and  $\text{LaH}_2$ , as well as many of the lanthanide and actinide hydrides  $\text{MH}_2$ , can absorb more hydrogen, forming compounds of limiting composition  $\text{MH}_3$ . Compositions such as  $\text{LaH}_{2.76}$  and  $\text{CeH}_{2.69}$  are found. The structures of these are complex, sometimes cubic and sometimes hexagonal. The third hydrogen atom is more loosely held than the others, and rather surprisingly it may occupy an octahedral hole.

4. Uranium is unusual and forms two different crystalline forms of  $\text{UH}_3$  that are stoichiometric.
5. Some elements (V, Nb, Ta, Cr, Ni and Pd) form hydrides approximating to  $\text{MH}$ . Formulae such as  $\text{NbH}_{0.7}$  and  $\text{PdH}_{0.6}$  are typical. These are less stable than the other hydrides, are nonstoichiometric and exist over a wide range of composition.

The Pd/ $\text{H}_2$  system is both extraordinary and interesting. When red hot Pd is cooled in  $\text{H}_2$  it may absorb or occlude up to 935 times its own volume of  $\text{H}_2$  gas. This may be used to separate  $\text{H}_2$  or deuterium  $\text{D}_2$  from He or other gases. The hydrogen is given off when the metal is heated, and this provides an easy method of weighing  $\text{H}_2$ . The limiting formula is  $\text{PdH}_{0.7}$ , but neither the structure nor the nature of the interaction between Pd and H are understood. As hydrogen is absorbed, the metallic conductivity decreases, and the material eventually becomes a semiconductor. The hydrogen is mobile and diffuses throughout the metal. It is possible that the erroneous reports of producing energy by 'cold-fusion' by electrolysis of  $\text{D}_2\text{O}$  at room temperature between Pd electrodes was really energy from the reaction between Pd and  $\text{D}_2$  rather than nuclear fusion of hydrogen or deuterium to give helium. (See Chapter 31.)

#### Intermediate hydrides

A few hydrides do not fit easily into the above classification. Thus  $(\text{BeH}_2)_n$  is polymeric, and is thought to be a chain polymer with hydrogen bridges.  $\text{MgH}_2$  has properties in between those of ionic and covalent hydrides.

$\text{CuH}$ ,  $\text{ZnH}_2$ ,  $\text{CdH}_2$  and  $\text{HgH}_2$  have properties intermediate between metallic and covalent hydrides. They are probably electron deficient like  $(\text{AlH}_3)_n$ .  $\text{CuH}$  is endothermic, that is energy must be put in to make the compound, and is formed by reducing  $\text{Cu}^{2+}$  with hypophosphorous acid. The hydrides of Zn, Cd and Hg are made by reducing the chlorides with  $\text{Li}[\text{AlH}_4]$ .

#### THE HYDROGEN ION

The energy required to remove the electron from a hydrogen atom (i.e. the ionization energy of hydrogen) is  $1311 \text{ kJ mol}^{-1}$ . This is a very large amount of energy, and consequently the bonds formed by hydrogen in the gas phase are typically covalent. Hydrogen fluoride is the compound most likely to contain ionic hydrogen (i.e.  $\text{H}^+$ ), since it has the greatest difference in electronegativity, but even here the bond is only 45% ionic.

Thus compounds containing  $\text{H}^+$  will only be formed if the ionization energy can be provided by some other process. Thus if the compound is dissolved, for example in water, then the hydration energy may offset the very high ionization energy. In water  $\text{H}^+$  are solvated, forming  $\text{H}_3\text{O}^+$ , and the energy evolved is  $1091 \text{ kJ mol}^{-1}$ . The remainder of the  $1311 \text{ kJ mol}^{-1}$  ionization energy comes from the electron affinity (the energy evolved in



forming the negative ion), and also the solvation energy of the negative ion.

Compounds which form solvated hydrogen ions in a suitable solvent are called acids. Even though the ions present are  $\text{H}_3\text{O}^+$  (or even  $\text{H}_9\text{O}_4^+$ ), it is customary to write the ion as  $\text{H}^+$ , indicating a hydrated proton.

## HYDROGEN BONDING

In some compounds a hydrogen atom is attracted by rather strong forces to two atoms, for example in  $[\text{F}-\text{H}-\text{F}]^-$ . (Sometimes hydrogen is attracted to more than two atoms.) It was at first thought that hydrogen formed two covalent bonds, but it is now recognized that, since hydrogen has the electronic structure  $1s^1$ , it can only form one covalent bond. The hydrogen bond is most simply regarded as a weak electrostatic attraction between a lone pair of electrons on one atom, and a covalently bonded hydrogen atom that carries a fractional charge  $\delta+$ .

Hydrogen bonds are formed only with the most electronegative atoms. (Of these, F, O, N and Cl are the four most important elements.) These bonds are very weak, and are typically about  $10 \text{ kJ mol}^{-1}$ , though hydrogen bonds may have a bond energy from 4 to  $45 \text{ kJ mol}^{-1}$ . This must be compared with a C—C covalent bond of  $347 \text{ kJ mol}^{-1}$ . Despite their low bond energy, hydrogen bonds are of great significance both in biochemical systems and in normal chemistry. They are extremely important because they are responsible for linking polypeptide chains in proteins, and for linking pairs of bases in large nucleic acid-containing molecules. The hydrogen bonds maintain these large molecules in specific molecular configurations, which is important in the operation of genes and enzymes. Hydrogen bonds are responsible for water being liquid at room temperature, and but for this, life as we know it would not exist. Since hydrogen bonds have a low bond energy, they also have a low activation energy, and this results in their playing an important part in many reactions at normal temperatures.

Hydrogen bonding was first used to explain the weakness of trimethylammonium hydroxide as a base compared with tetramethylammonium hydroxide. In the trimethyl compound the OH group is hydrogen bonded to the  $\text{Me}_3\text{NH}$  group (shown by a dotted line in Figure 8.4), and this makes it more difficult for the OH group to ionize, and hence it is a weak base. In the tetramethyl compound, hydrogen bonding cannot occur, so the OH group ionizes and the tetramethyl compound is thus a much stronger base.

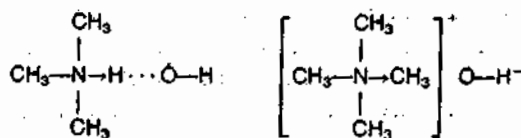
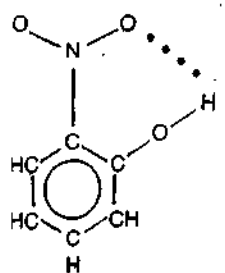
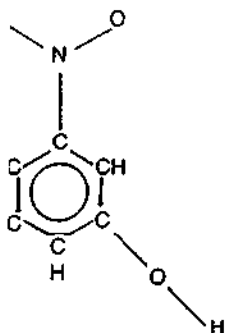

Figure 8.4 Structures of trimethyl and tetramethyl ammonium hydroxide.



ortho



meta

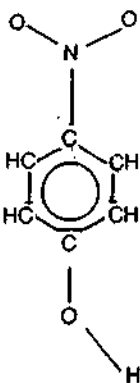

para

3.5 Structures of *ortho*,  
and *para* nitrophenol.

In a similar way the formation of an intramolecular hydrogen bond in *o*-nitrophenol reduces its acidity compared with *m*-nitrophenol and *p*-nitrophenol where the formation of a hydrogen bond is not possible (Figure 8.5).

Intermolecular hydrogen bonding may also take place, and it has a striking effect on the physical properties such as melting points, boiling points, and the enthalpies of vaporization and sublimation (Figure 8.6). In general the melting and boiling points for a related series of compounds increase as the atoms get larger, owing to the increase in dispersive force. Thus by extrapolating the boiling points of  $\text{H}_2\text{Te}$ ,  $\text{H}_2\text{Se}$  and  $\text{H}_2\text{S}$  one would predict that the boiling point of  $\text{H}_2\text{O}$  should be about  $-100^\circ\text{C}$ , whilst it is actually  $+100^\circ\text{C}$ . Thus water boils about  $200^\circ\text{C}$  higher than it would in the absence of hydrogen bonding.

In much the same way the boiling point of  $\text{NH}_3$  is much higher than would be expected by comparison with  $\text{PH}_3$ ,  $\text{AsH}_3$  and  $\text{SbH}_3$ , and similarly  $\text{HF}$  boils much higher than  $\text{HCl}$ ,  $\text{HBr}$  and  $\text{HI}$ . The reason for the higher than expected boiling points is hydrogen bonding. Note that the boiling points of the Group IV hydrides  $\text{CH}_4$ ,  $\text{SiH}_4$ ,  $\text{GeH}_4$  and  $\text{SnH}_4$ , and also those of the noble gases, change smoothly, as they do not involve hydrogen bonding.

The hydrogen bonds in  $\text{HF}$  link the  $\text{F}$  atom of one molecule with the  $\text{H}$  atom of another molecule, thus forming a zig-zag chain  $(\text{HF})_n$  in both the liquid and also in the solid. Some hydrogen bonding also occurs in the gas, which consists of a mixture of cyclic  $(\text{HF})_6$  polymers, dimeric  $(\text{HF})_2$ , and monomeric  $\text{HF}$ . (The hydrogen bond in  $\text{F}-\text{H}\cdots\text{F}$  is  $29\text{ kJ mol}^{-1}$  in  $\text{HF}_{(\text{gas})}$ .)

A similar pattern can be seen in the melting points and the enthalpies of vaporization of the hydrides, indicating hydrogen bonding in  $\text{NH}_3$ ,  $\text{H}_2\text{O}$  and  $\text{HF}$ , but not in  $\text{CH}_4$  or  $\text{Ne}$ .

Strong evidence for hydrogen bonding comes from structural studies. Examples include ice, which has been determined both by X-ray and neutron diffraction, the dimeric structure of formic acid (determined in the gas phase by electron diffraction), X-ray structures of the solids for sodium hydrogencarbonate and boric acid (Figure 8.8), and many others.

Another technique for studying hydrogen bonds is infra-red absorption spectra in  $\text{CCl}_4$  solution, which allows the  $\text{O}-\text{H}$  and  $\text{N}-\text{H}$  stretching frequencies to be studied.

### ACIDS AND BASES

There are several so-called *theories* of acids and bases, but they are not really theories but merely different definitions of what we choose to call an acid or a base. Since it is only a matter of definition, no theory is more right or wrong than any other, and we use the most convenient theory for a particular chemical situation. Which is the most useful theory or definition of acids and bases? There is no simple answer to this. The answer depends

on whether we are considering ionic reactions in aqueous solution, in non-aqueous solution, or in a fused melt, and whether we require a measure of the strengths of acids and bases. For this reason we need to know several theories.

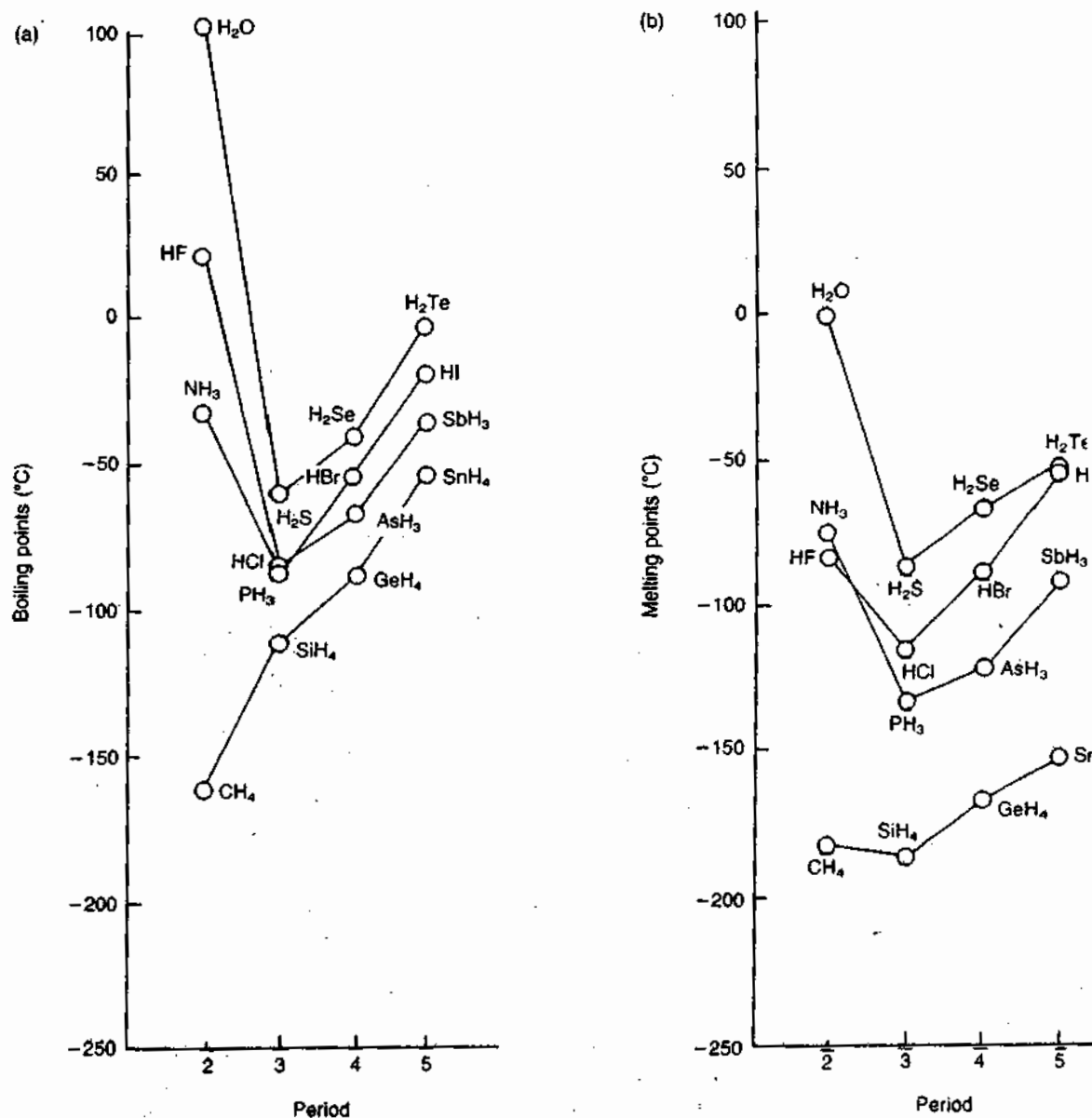

Figure 8.6 (a) Boiling points of hydrides. (b) Melting points of hydrides. (c) Enthalpies of vaporization of hydrides. (Adapted from Lagowski, J.J., *Modern Inorganic Chemistry*, Marcel Dekker, New York, p. 174.)

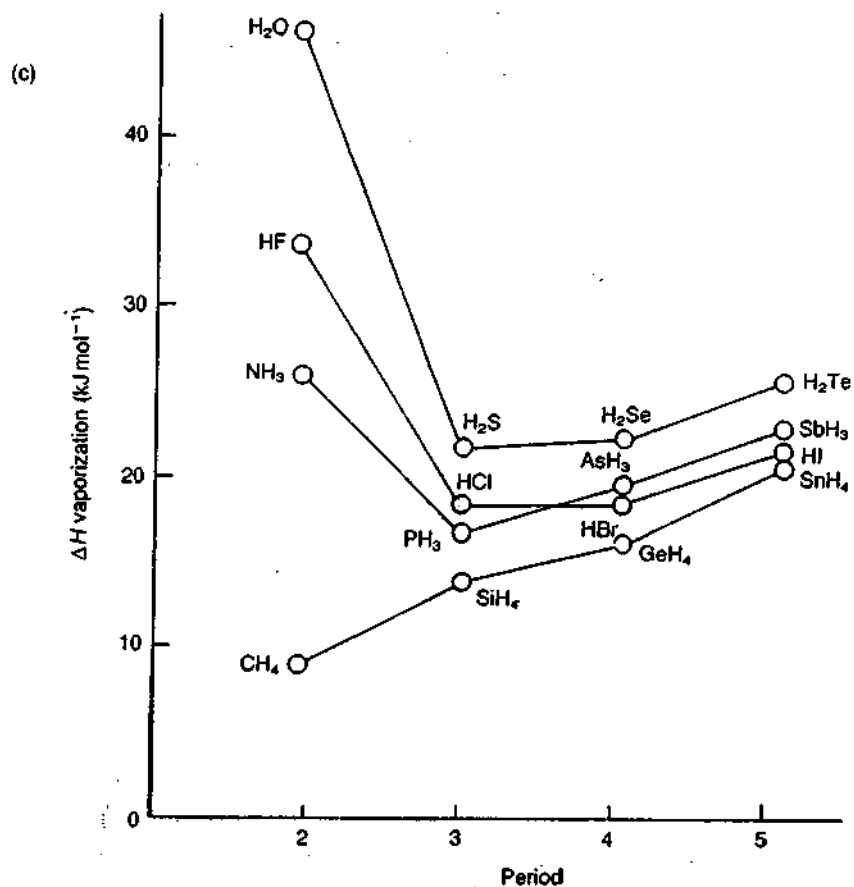

Figure 8.6 continued.

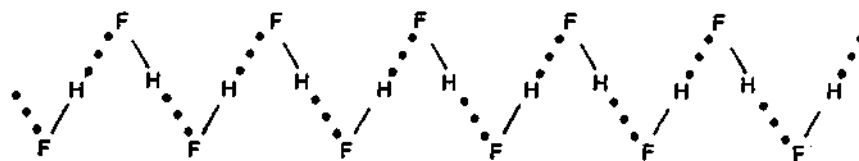

Figure 8.7 Hydrogen bonded chain in solid HF.

### Arrhenius theory

In the early stages of chemistry, acids were distinguished by their sour taste and their effect on certain plant pigments such as litmus. Bases were substances which reacted with acids to form salts. Water was used almost exclusively for reactions in solution, and in 1884 Arrhenius suggested the theory of electrolytic dissociation and proposed the self-ionization of water:

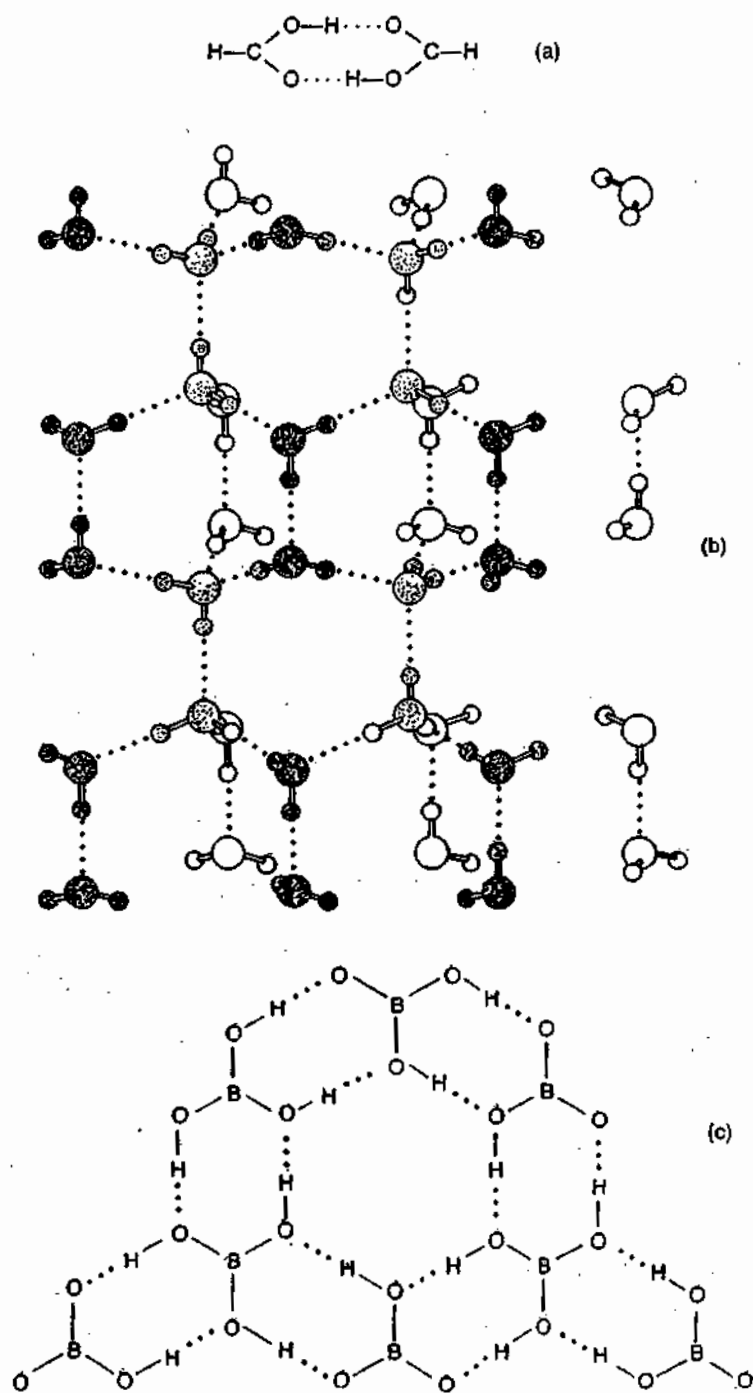
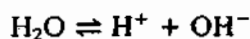
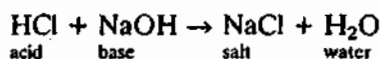

Figure 8.8 Hydrogen bonded structures. (a) Formic acid dimer,  $(\text{HCOOH})_2$ . (b) Ice. (From L. Pauling, *The Nature of the Chemical Bond*, 3rd ed., pp. 449–504, Cornell University Press, Ithaca, 1960.) (c) A layer of crystalline  $\text{H}_3\text{BO}_3$ .



Thus substances producing  $\text{H}^+$  were called acids, and substances producing  $\text{OH}^-$  were called bases. A typical neutralization reaction is



or simply



In aqueous solutions the concentration of  $\text{H}^+$  is often given in terms of pH, where:

$$\text{pH} = \log_{10} \frac{1}{[\text{H}^+]} = -\log_{10}[\text{H}^+]$$

where  $[\text{H}^+]$  is the hydrogen ion concentration. More strictly the activity of the hydrogen ions should be used. This logarithmic scale is very useful for expressing concentrations over several orders of magnitude (e.g. 1 M  $\text{H}^+$  is pH 0,  $10^{-14}$  M  $\text{H}^+$  is pH 14).

Until the turn of the nineteenth century it was thought that water was the only solvent in which ionic reactions could occur. Studies made by Cady in 1897 and by Franklin and Kraus in 1898 on reactions in liquid ammonia, and by Walden in 1899 on reactions in liquid sulphur dioxide, revealed many analogies with reactions in water. These analogies suggested that the three media were ionizing solvents and could be useful for ionic reactions, and that acids, bases and salts were common to all three systems.

Although water is still the most widely used solvent, its exclusive use limited chemistry to those compounds which are stable in its presence. Non-aqueous solvents are now used increasingly in inorganic chemistry because many new compounds can be prepared which are unstable in water, and some anhydrous compounds can be prepared, such as anhydrous copper nitrate, which differ markedly from the well known hydrated form. The concepts of acids and bases based on the aqueous system need extending to cover non-aqueous solvents.

#### Acids and bases in proton solvents

Water self-ionizes:

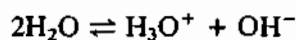

The equilibrium constant for this reaction depends on the concentration of water  $[\text{H}_2\text{O}]$ , and on the concentrations of the ions  $[\text{H}_3\text{O}^+]$  and  $[\text{OH}^-]$ .

$$K_1 = \frac{[\text{H}_3\text{O}^+][\text{OH}^-]}{[\text{H}_2\text{O}]^2}$$

Since water is in large excess, its concentration is effectively constant, so the ionic product of water may be written:

Table 8.4 Ionic product of water at various temperatures

Temperature (°C)	$K_w(\text{mol}^2\text{l}^{-2})$
0	$0.12 \times 10^{-14}$
10	$0.29 \times 10^{-14}$
20	$0.68 \times 10^{-14}$
25	$1.00 \times 10^{-14}$
30	$1.47 \times 10^{-14}$
40	$2.92 \times 10^{-14}$
100	$47.6 \times 10^{-14}$

$$K_w = [\text{H}_3\text{O}^+][\text{OH}^-] = 10^{-14} \text{ mol}^2\text{l}^{-2}$$

The value of  $K_w$  is  $1.00 \times 10^{-14} \text{ mol}^2\text{l}^{-2}$  at  $25^\circ\text{C}$ , but it varies with temperature. Thus at  $25^\circ\text{C}$  there will be  $10^{-7} \text{ mol l}^{-1}$  of  $\text{H}_3\text{O}^+$  and  $10^{-7} \text{ mol l}^{-1}$  of  $\text{OH}^-$  in pure water.

Acids such as HA increase the concentration of  $\text{H}_3\text{O}^+$ :

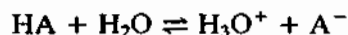

$$K_w = \frac{[\text{H}_3\text{O}^+][\text{A}^-]}{[\text{HA}][\text{H}_2\text{O}]}$$

In dilute solution water is in such a large excess that the concentration of water is effectively constant (approximately 55M), and this constant can be incorporated in the constant at the left hand side. Thus:

$$K_a = \frac{[\text{H}_3\text{O}^+][\text{A}^-]}{[\text{HA}]}$$

Table 8.5 Relation between pH,  $[\text{H}^+]$  and  $[\text{OH}^-]$ 

pH	$[\text{H}^+]$ ( $\text{mol l}^{-1}$ )	$[\text{OH}^-]$ ( $\text{mol l}^{-1}$ )	
0	$10^0$	$10^{-14}$	} Acidic
1	$10^{-1}$	$10^{-13}$	
2	$10^{-2}$	$10^{-12}$	
3	$10^{-3}$	$10^{-11}$	
4	$10^{-4}$	$10^{-10}$	
5	$10^{-5}$	$10^{-9}$	} Neutral
6	$10^{-6}$	$10^{-8}$	
7	$10^{-7}$	$10^{-7}$	} Basic
8	$10^{-8}$	$10^{-6}$	
9	$10^{-9}$	$10^{-5}$	
10	$10^{-10}$	$10^{-4}$	
11	$10^{-11}$	$10^{-3}$	
12	$10^{-12}$	$10^{-2}$	
13	$10^{-13}$	$10^{-1}$	
14	$10^{-14}$	$10^0$	

The pH scale is used to measure the activity of hydrogen ions ( $\text{pH} = -\log[\text{H}^+]$ ), and it refers to the number of powers of ten used to express the concentration of hydrogen ions. In a similar way the acid dissociation constant  $K_a$  may be expressed as a  $\text{p}K_a$  value:

$$\text{p}K_a = \log \frac{1}{K_a} = -\log K_a$$

Thus  $\text{p}K_a$  is a measure of the strength of an acid. If the acid ionizes almost completely (high acid strength) then  $K_a$  will be large, and thus  $\text{p}K_a$  will be small. The  $\text{p}K_a$  values given below show that acid strength increases on moving from left to right in the periodic table:

	$\text{CH}_4$	$\text{NH}_3$	$\text{H}_2\text{O}$	$\text{HF}$
$\text{p}K_a$	46	35	16	3

Acid strength also increases on moving down a group:

	$\text{HF}$	$\text{HCl}$	$\text{HBr}$	$\text{HI}$
$\text{p}K_a$	3	-7	-9	-10

With oxoacids containing more than one hydrogen atom, successive dissociation constants rapidly become more positive, i.e. the phosphate species formed on successive removal of  $\text{H}^+$  become less acidic:

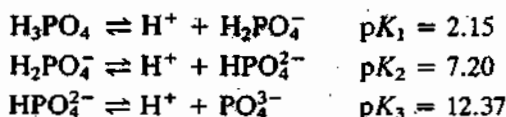

If an element forms a series of oxoacids, then the more oxygen atoms present, the more acidic it will be. The reason for this is that the electrostatic attraction for the proton decreases as the negative charge is spread over more atoms, thus facilitating ionization.

<i>very weak acid</i>	<i>weak acid</i>	<i>strong acid</i>	<i>very strong acid</i>
$\text{HNO}_2$ $\text{p}K_a = 3.3$	$\text{HNO}_3$ $\text{p}K_a = -1.4$		
$\text{H}_2\text{SO}_3$ $\text{p}K_a = 1.9$	$\text{H}_2\text{SO}_4$ $\text{p}K_a = (-1)$		
$\text{HOCl}$ $\text{p}K_a = 7.2$	$\text{HClO}_2$ $\text{p}K_a = 2.0$	$\text{HClO}_3$ $\text{p}K_a = -1$	$\text{HClO}_4$ $\text{p}K_a = (-10)$

#### Bronsted-Lowry theory

In 1923, Bronsted and Lowry independently defined acids as proton donors, and bases as proton acceptors.

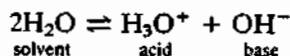

For aqueous solutions, this definition does not differ appreciably from the Arrhenius theory. Water self-ionizes as shown above. Substances that increase the concentration of  $[\text{H}_3\text{O}]^+$  in an aqueous solution above the



value of  $10^{-7} \text{ mol}^2 \text{ l}^{-2}$  from the self-ionization are acids, and those that decrease it are bases.

The Bronsted-Lowry theory is useful in that it extends the scope of acid-base systems to cover solvents such as liquid ammonia, glacial acetic acid, anhydrous sulphuric acid, and all hydrogen-containing solvents. It should be emphasized that bases accept protons, and there is no need for them to contain  $\text{OH}^-$ .

In liquid ammonia:

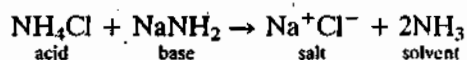

or simply:

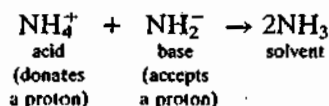

Similarly in sulphuric acid:



Chemical species that differ in composition only by a proton are called 'a conjugate pair'. Thus every acid has a conjugate base, which is formed when the acid donates a proton. Similarly every base has a conjugate acid.

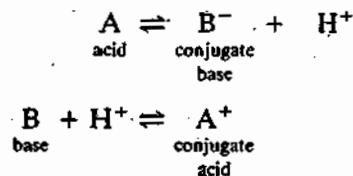

In water

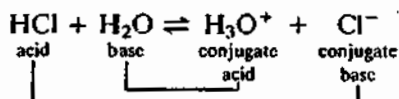

In the above reaction, HCl is an acid since it donates protons, and in doing so forms  $\text{Cl}^-$ , its conjugate base. Since  $\text{H}_2\text{O}$  accepts protons it is a base, and forms  $\text{H}_3\text{O}^+$ , its conjugate acid. A strong acid has a weak conjugate base and vice versa.

In liquid ammonia:

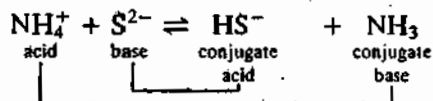

In liquid ammonia all ammonium salts act as acids since they can donate protons, and the sulphide ion acts as a base since it accepts protons. The

reaction is reversible, and it will proceed in the direction that produces the weaker species, in this case  $\text{HS}^-$  and  $\text{NH}_3$ .

*A limitation of the Bronsted-Lowry theory is that the extent to which a dissolved substance can act as an acid or a base depends largely on the solvent.* The solute only shows acidic properties if its proton-donating properties exceed those of the solvent. This sometimes upsets our traditional ideas on what are acids, which are based on our experience of what happens in water. Thus  $\text{HClO}_4$  is an extremely strong proton donor. If liquid  $\text{HClO}_4$  is used as a solvent, then  $\text{HF}$  dissolved in this solvent is forced to accept protons, and thus act as a base.

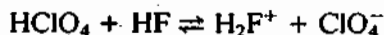

In a similar way  $\text{HNO}_3$  is forced to accept protons and thus act as a base in both  $\text{HClO}_4$  and liquid  $\text{HF}$  as solvent.

Water has only a weak tendency to donate protons. The mineral acids ( $\text{HCl}$ ,  $\text{HNO}_3$ ,  $\text{H}_2\text{SO}_4$  etc.) all have a much stronger tendency to donate protons. Thus in aqueous solutions the mineral acids all donate protons to the water, thus behaving as acids, and in the process the mineral acids ionize completely.

In liquid ammonia as solvent, the acids which were strong acids in water all react completely with the ammonia, forming  $\text{NH}_4^+$ .

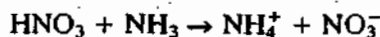
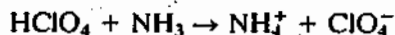

Acids which were slightly less strong in water also react completely with  $\text{NH}_3$ , forming  $\text{NH}_4^+$ .

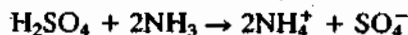

Weak acids in water, such as oxalic acid, also react completely with  $\text{NH}_3$ .

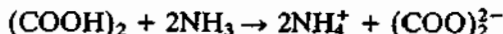

The acid strengths have all been levelled by the solvent liquid ammonia: hence liquid ammonia is called a levelling solvent. It even makes some molecules, such as urea, which show no acidic properties in water, behave as weak acids.

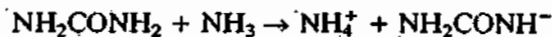

Differentiating solvents such as glacial acetic acid emphasize the difference in acid strength, and several mineral acids are only partially ionized in this solvent. This is because acetic acid itself is a proton donor, and if a substance dissolved in acetic acid is to behave as an acid, it must donate protons more strongly than acetic acid. Thus the dissolved material must force the acetic acid to accept protons (i.e. the acetic acid behaves as a base). Thus the solvent acetic acid makes it more difficult for the usual acids to ionize, and conversely it will encourage the usual bases to ionize completely. It follows that a differentiating solvent for acids will act as a levelling solvent for bases, and vice versa.

### Lewis theory

Lewis developed a definition of acids and bases that did not depend on the presence of protons, nor involve reactions with the solvent. He defined acids as materials which accept electron pairs, and bases as substances which donate electron pairs. Thus a proton is a Lewis acid and ammonia is a Lewis base since the lone pair of electrons on the nitrogen atom can be donated to a proton:

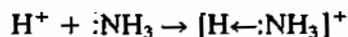

Similarly hydrogen chloride is a Lewis acid because it can accept a lone pair from a base such as water though this is followed by ionization:

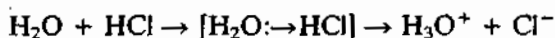

Though this is a more general approach than that involving protons, it has several drawbacks:

1. Many substances, such as  $\text{BF}_3$  or metal ions, that are not normally regarded as acids, behave as Lewis acids. This theory also includes reactions where no ions are formed, and neither hydrogen ions nor any other ions are transferred (e.g.  $\text{Ni}(\text{CO})_4$ ).

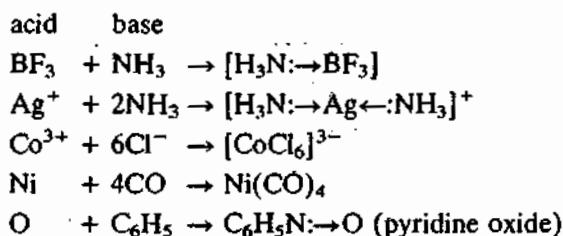

2. There is no scale of acid or basic strength, since the strength of an acid or a base compound is not constant, and varies from one solvent to another, and also from one reaction to another.
3. Almost all reactions become acid-base reactions under this system.

### The solvent system

Perhaps the most convenient general definition of acids and bases is due to Cady and Eley, and can be applied in all cases where the solvent undergoes self-ionization, regardless of whether it contains protons or not.

Many solvents undergo self-ionization, and form positive and negative ions in a similar way to water:

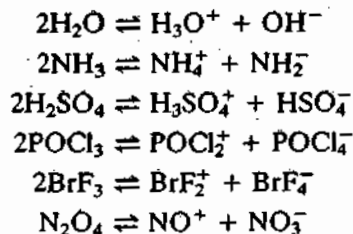

Acids are defined as substances that increase the concentration of the positive ions characteristic of the solvent ( $\text{H}_3\text{O}^+$  in the case of water,  $\text{NH}_4^+$  in liquid ammonia, and  $\text{NO}^+$  in  $\text{N}_2\text{O}_4$ ). Bases are substances that increase the concentration of the negative ions characteristic of the solvent ( $\text{OH}^-$  in water,  $\text{NH}_2^-$  in ammonia,  $\text{NO}_3^-$  in  $\text{N}_2\text{O}_4$ ).

There are two advantages to this approach. First, most of our traditional ideas on what are acids and bases in water remain unchanged, as do neutralization reactions. Second, it allows us to consider non-aqueous solvents by analogy with water.

Thus water ionizes, giving  $\text{H}_3\text{O}^+$  and  $\text{OH}^-$  ions. Substances providing  $\text{H}_3\text{O}^+$  (e.g.  $\text{HCl}$ ,  $\text{KNO}_3$  and  $\text{H}_2\text{SO}_4$ ) are acids, and substances providing  $\text{OH}^-$  (e.g.  $\text{NaOH}$  and  $\text{NH}_4\text{OH}$ ) are bases. Neutralization reactions are of the type *acid + base  $\rightarrow$  salt + water*.

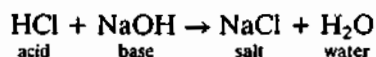

Similarly liquid ammonia ionizes, giving  $\text{NH}_4^+$  and  $\text{NH}_2^-$  ions. Thus ammonium salts are acids since they provide  $\text{NH}_4^+$  ions, and sodamide  $\text{NaNH}_2$  is a base since it provides  $\text{NH}_2^-$  ions. Neutralization reactions are of the type *acid + base  $\rightarrow$  salt + solvent*.

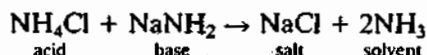

$\text{N}_2\text{O}_4$  self-ionizes into  $\text{NO}^+$  and  $\text{NO}_3^-$  ions. Thus in  $\text{N}_2\text{O}_4$  as solvent,  $\text{NOCl}$  is an acid since it produces  $\text{NO}^+$ , and  $\text{NaNO}_3$  is a base since it produces  $\text{NO}_3^-$ .

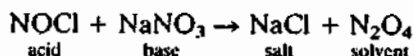

Clearly this definition applies equally well to proton and non-proton systems. This broader definition also has advantages when considering protonic solvents, since it explains why the acidic or basic properties of a solute are not absolute, and depend in part on the solvent. We normally regard acetic acid as an acid, because in water it produces  $\text{H}_3\text{O}^+$ .



However, acetic acid behaves as a base when sulphuric acid is the solvent since  $\text{H}_2\text{SO}_4$  is a stronger proton donor than  $\text{CH}_3\text{COOH}$ . In a similar way  $\text{HNO}_3$  is forced to behave as a base in  $\text{H}_2\text{SO}_4$  as solvent, and this is important in producing nitronium ions  $\text{NO}_2^+$  in the nitration of organic compounds by a mixture of concentrated  $\text{H}_2\text{SO}_4$  and  $\text{HNO}_3$ .

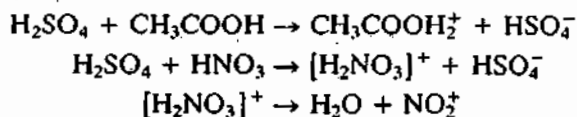

### The Lux–Flood definition

Lux originally proposed a different definition of acids and bases which was extended by Flood. Instead of using protons, or ions characteristic of the solvent, they defined acids as oxides which accept oxygen, and bases as oxides which donate oxygen. Thus:

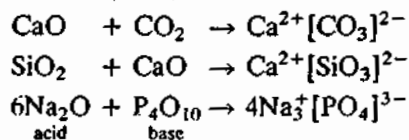

This system is very useful in dealing with anhydrous reactions in fused melts of oxides, and other high temperature reactions such as are found in metallurgy and ceramics.

This theory has an inverse relationship to aqueous chemistry, since Lux–Flood acids are oxides which react with water, giving bases in water, and Lux–Flood bases react with water, giving acids.

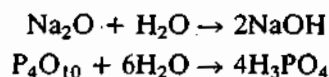

### The Usanovich definition

This defines an acid as any chemical species which reacts with bases, gives up cations, or accepts anions or electrons. Conversely a base is any chemical species which reacts with acids, gives up anions or electrons, or combines with cations. This is a very wide definition and includes all the Lewis acid–base type of reactions, and in addition it includes redox reactions involving the transfer of electrons.

### Hard and soft acids and bases

Metal ions may be divided into two types depending on the strength of their complexes with certain ligands.

*Type (a) metals* include the smaller ions from Groups I and II, and the left hand side of the transition metals, particularly when in high oxidation states, and these form the most stable complexes with nitrogen and oxygen donors (ammonia, amines, water, ketones, alcohols), and also with  $\text{F}^-$  and  $\text{Cl}^-$ .

*Type (b) metals* include ions from the right hand side of the transition series, and also transition metal complexes with low oxidation states, such as the carbonyls. These form the most stable complexes with ligands such as  $\text{I}^-$ ,  $\text{SCN}^-$  and  $\text{CN}^-$ .

This empirical classification was useful in predicting the relative stabilities of complexes. Pearson extended the concept into a broad range of acid–base interactions. Type (a) metals are small and not very polariz-

Table 8.6 Some hard and soft acids and bases

<i>Hard acids</i>	<i>Soft acids</i>
H <sup>+</sup>	Pd <sup>2+</sup> , Pt <sup>2+</sup> , Cu <sup>+</sup> , Ag <sup>+</sup> , Au <sup>+</sup> , Hg <sup>2+</sup> ,
Li <sup>+</sup> , Na <sup>+</sup> , K <sup>+</sup> ,	(Hg <sub>2</sub> ) <sup>2+</sup> , Tl <sup>+</sup>
Be <sup>2+</sup> , Mg <sup>2+</sup> , Ca <sup>2+</sup> , Sr <sup>2+</sup> ,	B(CH <sub>3</sub> ) <sub>3</sub> , B <sub>2</sub> H <sub>6</sub> , Ga(CH <sub>3</sub> ) <sub>3</sub> , GaCl <sub>3</sub> ,
Al <sup>3+</sup> , BF <sub>3</sub> , Al(CH <sub>3</sub> ) <sub>3</sub> , AlCl <sub>3</sub> ,	GaBr <sub>3</sub> , GaI <sub>3</sub>
Sc <sup>3+</sup> , Ti <sup>4+</sup> , Zr <sup>4+</sup> , VO <sup>2+</sup> , Cr <sup>3+</sup> ,	[Fe(CO) <sub>5</sub> ], [Co(CN) <sub>5</sub> ] <sup>3-</sup>
MoO <sup>3+</sup> , WO <sup>4+</sup> ,	
Ce <sup>3+</sup> , Lu <sup>3+</sup> ,	
CO <sub>2</sub> , SO <sub>3</sub>	
<i>Hard bases</i>	<i>Soft bases</i>
NH <sub>3</sub> , RNH <sub>2</sub> , N <sub>2</sub> H <sub>4</sub>	H <sup>-</sup> , CN <sup>-</sup> , SCN <sup>-</sup> , S <sub>2</sub> O <sub>3</sub> <sup>2-</sup> , I <sup>-</sup> , RS <sup>-</sup> ,
H <sub>2</sub> O, ROH, R <sub>2</sub> O	R <sub>2</sub> S, CO, B <sub>2</sub> H <sub>6</sub> , C <sub>2</sub> H <sub>4</sub> , R <sub>3</sub> P, P(OR) <sub>3</sub>
OH <sup>-</sup> , NO <sub>3</sub> <sup>-</sup> , ClO <sub>4</sub> <sup>-</sup> , CO <sub>3</sub> <sup>2-</sup> , SO <sub>4</sub> <sup>2-</sup> ,	
PO <sub>4</sub> <sup>3-</sup> , CH <sub>3</sub> COO <sup>-</sup> , F <sup>-</sup> , Cl <sup>-</sup>	

able, and these prefer ligands that are also small and not very polarizable. Pearson called these metals hard acids, and the ligands hard bases. In a similar way, type (b) metals and the ligands they prefer are larger and more polarizable, and he called these soft acids and soft bases. He stated the relationship *hard acids prefer to react with hard bases, and soft acids react with soft bases*. This definition takes in the usually accepted acid-base reactions (H<sup>+</sup> strong acid, OH<sup>-</sup> and NH<sub>3</sub> strong bases), and in addition a great number of reactions involving the formation of simple complexes, and complexes with  $\pi$  bonding ligands.

## FURTHER READING

### Hydrogen

- Brown, H.C. (1979) Hydride reductions: A 40 year revolution in organic chemistry, *Chem. Eng. News*, March 5, 24-29.
- Emeléus, H.J. and Sharpe A.G. (1973) *Modern Aspects of Inorganic Chemistry*, 4th ed. (Chapter 8: Hydrogen and the Hydrides), Routledge and Kegan Paul, London.
- Evans, E.A. (1974) *Tritium and its Compounds*, 2nd ed., Butterworths, London, (Contains over 4000 references.)
- Grant, W.J. and Redfearn, S.L. (1977) Industrial gases, in *The Modern Inorganic Chemicals Industry* (ed. Thompson, R.), The Chemical Society, London, Special Publication no. 31.
- Jolly, W.L. (1976) *The Principles of Inorganic Chemistry*, (Chapters 4 and 5), McGraw Hill, New York.
- Mackay, K.M. (1966) *Hydrogen Compounds of the Metallic Elements*, Spon, London.
- Mackay, K.M. (1973) *Comprehensive Inorganic Chemistry*, Vol. 1 (Chapter 1: The element hydrogen; Chapter 2 Hydrides), Pergamon Press, Oxford.

- Mackay, K.M. and Dove, M.F.A. (1973) *Comprehensive Inorganic Chemistry*, Vol. 1 (Chapter 3: Deuterium and Tritium), Pergamon Press, Oxford.
- Moore, D.S. and Robinson, S.D. (1983) Hydrido complexes of the transition metals, *Chem. Soc. Rev.*, **12**, 415-452.
- Muetterties, E.L. (1971) *Transition Metal Hydrides*, Marcel Dekker, New York.
- Sharpe, A.G. (1981) *Inorganic Chemistry* (Chapter 9), Longmans, London.
- Stinson, S.C. (1980) Hydride reducing agents, use expanding, *Chem. Eng. News*, Nov 3, 18-20.
- Wiberg, E. and Amberger, E. (1971) *Hydrides*, Elsevier.

### The hydrogen economy

- McAuliffe, C.A. (1973) The hydrogen economy, *Chemistry in Britain*, **9**, 559-563.
- Marchetti, C. (1977) The hydrogen economy and the chemist, *Chemistry in Britain*, **13**, 219-222.
- Williams, L.O. (1980) *Hydrogen Power: An Introduction to Hydrogen Energy and Its Applications*, Pergamon Press, Oxford.

### Hydrogen bonding

- Coulson, C. A. (1979) *Valence*. Oxford University Press, Oxford. 3rd ed. by McWeeny, R. (This is an updated version of Coulson's 1952 book.)
- DeKock, R.L. and Gray, H.B. (1980) *Chemical Structure and Bonding*, Benjamin/Cummings, Menlo Park, California.
- Douglas, B., McDaniel, D.H. and Alexander, J.J. (1982) *Concepts and Models of Inorganic Chemistry*, 2nd ed (Chapter V: The Hydrogen Bond), John Wiley, New York.
- Emsley, J. (1980) Very strong hydrogen bonds, *Chem. Soc. Rev.*, **9**, 91-124.
- Joesten, M.D. and Schaad, L.J. (1974) *Hydrogen Bonding*, Marcel Dekker, New York.
- Pauling, L. (1960) *The Nature of the Chemical Bond* (Chapter 12), 3rd ed., Oxford University Press, London.
- Pimentel, G.C. and McClellan, A.L. (1960) *The Hydrogen Bond*, W.H. Freeman, San Francisco. (A well written monograph, with over 2200 references. Dated but thorough.)
- Vinogradov, S.N. and Linnell, R.H. (1971) *Hydrogen Bonding*, Van Nostrand Reinhold, New York. (Good general treatment.)
- Wells, A.F. (1984) *Structural Inorganic Chemistry*, 5th ed., Oxford University Press, Oxford.

### Acids and bases

- Bell, R.P. (1973) *The Proton in Chemistry*, 2nd ed., Chapman and Hall, London.
- Bronsted, J.N. (1923) *Rec. Trav. Chim.*, **42**, 718. (Original paper on the Bronsted theory.)
- Cady, H.P. and Elsey, H.M. (1928) A general definition of acids, bases and salts, *J. Chem. Ed.*, **5**, 1425. (Original paper on the solvent system.)
- Drago, R.S. (1974) A Modern approach to acid-base chemistry, *J. Chem. Ed.*, **51**, 300.
- Finston, H.L. and Rychman, A.C. (1982) *A New View of Current Acid-Base Theories*, John Wiley, Chichester.
- Fogg, P.G.T. and Gerrard, W. (eds) (1990) *Hydrogen Halides in Non-Aqueous Solvents*, Pergamon, New York.
- Gillespie, R.J. (1973) The chemistry of the superacid system, *Endeavour*, **32**, 541.

- Gillespie, R.J. (1975) Proton acids, Lewis acids, hard acids, soft acids and superacids, Chapter 1 in *Proton Transfer Reactions* (ed. Caldin, E. and Gold, V.), Chapman and Hall, London.
- Hand, C.W. and Blewitt, H.L. (1986) *Acid-Base Chemistry*, Macmillan, New York; Collier Macmillan, London.
- Huheey, J.E. (1978) *Inorganic Chemistry*, 2nd ed. (Chapter 7), Harper and Row, New York.
- Jensen, W.B. (1980) *The Lewis Acid-Base Concepts*, Wiley, New York and Chichester.
- Koltoff, I.M. and Elving, P.J. (1986) (eds), *Treatise on Analytical Chemistry*, 2nd ed., Vol. 2, Part 1, Wiley, Chichester, 157-440.
- Olah, G.A., Surya Prakask, G.K., and Sommer, J. (1985) *Superacids*, Wiley, Chichester and Wiley-Interscience, New York.
- Pearson, R.G. (1987) Recent advances in the concept of hard and soft acids and bases, *J. Chem. Ed.* 64, 561-567.
- Smith, D.W. (1987) An acidity scale for binary oxides, *J. Chem. Ed.*, 64, 480-481.
- Vogel, A.I., Jeffery, G.H., Bassett, J., Mendham, J. and Denney, R.C. (1990) *Vogel's Textbook of Quantitative Chemical Analysis*, 5th ed., Halstead Press. (Indicators, acid-base titrations, weak acids and bases, buffers etc.)

#### Water and solutions

- Burgess, J. (1988) *Ions in Solution*, Ellis Horwood, Chichester.
- Franks, F. (1984) *Water*, 1st revised ed., Royal Society for Chemistry, London.
- Hunt, J.P. and Friedman, H.L. (1983) Aquo complexes of metal ions, *Progr. in Inorg. Chem.*, 30, 359-387.
- Murrell, J.N. and Boucher, E.A. (1982) *Properties of Liquids and Solutions*, John Wiley, Chichester.
- Nielson, G.W. and Enderby, J.E. (eds) (1986) *Water and Aqueous Solutions*, Colston Research Society 37th Symposium (University of Bristol), Adam Hilger, Bristol.
- Symons, M.C.R. (1989) Liquid water - the story unfolds, *Chemistry in Britain*, 25, 491-494.

#### Non-aqueous solvents

- Addison, C.C. (1980) Dinitrogen tetroxide, nitric acid and their mixtures as media for inorganic reactions, *Chem. Rev.*, 80, 21-39.
- Addison, C.C. (1984) *The Chemistry of the Liquid Alkali Metals*, John Wiley, Chichester.
- Burger, K. (1983) *Ionic Solvation and Complex Formation Reactions in Non-Aqueous Solvents*, Elsevier, New York.
- Emel us, H.J. and Sharpe, A.G. (1973) *Modern Aspects of Inorganic Chemistry*, 4th ed. (Chapter 7: Reactions in Non-Aqueous Solvents; Chapter 8: Hydrogen and the hydrides), Routledge and Kegan Paul, London.
- Gillespie, R.J. and Robinson, E.A. (1959) The sulphuric acid solvent system, *Adv. Inorg. Chem. Radiochem.*, 1, 385.
- Lagowski, J. (ed.) (1978) *The Chemistry of Non-aqueous Solvents*, Academic Press, New York.
- Nicholls, D. (1979) *Inorganic Chemistry in Liquid Ammonia* (Topics in Inorganic and General Chemistry, Monograph 17), Elsevier, Oxford.
- Popovych, O. and Tomkins, R.P.T. (1981) *Non Aqueous Solution Chemistry*, Wiley, Chichester.
- Waddington, T.C. (ed.) (1969) *Non Aqueous Solvent Systems*, Nelson.



## PROBLEMS

1. Suggest reasons for and against the inclusion of hydrogen in the main groups of the periodic table.
2. Describe four ways in which hydrogen is produced on an industrial scale. Give one convenient method of preparing hydrogen in the laboratory.
3. Give an account of the main uses of hydrogen.
4. Give equations to show the reaction of hydrogen with: (a) Na, (b) Ca, (c) CO, (d) N, (e) S, (f) Cl, (g) CuO.
5. Describe the different types of hydrides which are formed.
6. Give examples of six proton solvents other than water, and show how they self-ionize.
7. What species are characteristic of acids and of bases in the following solvents: (a) liquid ammonia, anhydrous acetic acid, (b) anhydrous nitric acid, (c) anhydrous HF, (d) anhydrous perchloric acid, (e) anhydrous sulphuric acid, (f) dinitrogen tetroxide.
8. Describe how the various physical properties of a liquid affect its usefulness as a solvent.
9. How are the properties of  $\text{H}_2\text{O}$ ,  $\text{NH}_3$  and HF affected by hydrogen bonding?
10. Explain the variation in boiling points of the hydrogen halides (HF  $20^\circ\text{C}$ , HCl  $-85^\circ\text{C}$ , HBr  $-67^\circ\text{C}$  and HI  $-36^\circ\text{C}$ ).
11. Discuss the theoretical background, practical uses and theoretical limitations of liquid hydrogen fluoride as a non-aqueous solvent. List materials which behave as acids and bases in this solvent, and explain what happens when  $\text{SbF}_5$  is dissolved in HF.
12. Discuss the theoretical background, practical uses and limitations of liquid ammonia non-aqueous solvent. Explain what happens when  $^{15}\text{NH}_4\text{Cl}$  is dissolved in unlabelled liquid ammonia and the solvent evaporated.



# The s-Block Elements

Part  
Two



# Group I – the alkali metals

# 9

Table 9.1 Electronic structures

Element	Symbol	Electronic structure
Lithium	Li	$1s^2 2s^1$
Sodium	Na	$1s^2 2s^2 2p^6 3s^1$
Potassium	K	$1s^2 2s^2 2p^6 3s^2 3p^6 4s^1$
Rubidium	Rb	$1s^2 2s^2 2p^6 3s^2 3p^6 3d^{10} 4s^2 4p^6 5s^1$
Caesium	Cs	$1s^2 2s^2 2p^6 3s^2 3p^6 3d^{10} 4s^2 4p^6 4d^{10} 5s^2 5p^6 6s^1$
Francium	Fr	[Rn] $7s^1$

## INTRODUCTION

The elements of Group I illustrate, more clearly than any other group of elements, the effects of increasing the size of atoms or ions on the physical and chemical properties. They form a closely related group, and probably have the least complicated chemistry of any group in the periodic table. The physical and chemical properties of the elements are closely related to their electronic structures and sizes. The elements are all metals, excellent conductors of electricity, and are typically soft and highly reactive. They have one loosely held valence electron in their outer shell, and typically form univalent, ionic and colourless compounds. The hydroxides and oxides are very strong bases, and the oxosalts are very stable.

Lithium, the first element in the group, shows considerable differences from the rest of the group. In all of the main groups the first element shows a number of differences from the later elements in the group.

Sodium and potassium together make up over 4% by weight of the earth's crust. Their compounds are very common, and have been known and used from very early times. Some of their compounds are used in very large amounts. World production of NaCl was 179.6 million tonnes in 1988. (Most was used to make NaOH and  $Cl_2$ .) Thirty-four million tonnes of NaOH were produced in 1985. About 22 million tonnes/year of  $Na_2CO_3$  is used, and  $NaHCO_3$ ,  $Na_2SO_4$  and NaOCl are also of industrial importance. World production of potassium salts (referred to as 'potash' and measured as  $K_2O$ ) was 32.1 million tonnes in 1988. Much of it was used as fertilizers, but KOH,  $KNO_3$  and  $K_2O$  are also important. In addition

sodium and potassium are essential elements for animal life. The metals were first isolated by Humphrey Davy in 1807 by the electrolysis of KOH and NaOH.

### OCCURRENCE AND ABUNDANCE

Despite their close chemical similarity, the elements do not occur together, mainly because their ions are of different size.

Lithium is the thirty-fifth most abundant element by weight and is

**Table 9.2** Abundance of the elements in the earth's crust, by weight

	Abundance in earth's crust		Relative abundance
	(ppm)	(%)	
Li	18	0.0018	35
Na	22700	2.27	7
K	18400	1.84	8
Rb	78	0.0078	23
Cs	2.6	0.00026	46

mainly obtained as the silicate minerals, spodumene  $\text{LiAl}(\text{SiO}_3)_2$ , and lepidolite  $\text{Li}_2\text{Al}_2(\text{SiO}_3)_3(\text{FOH})_2$ . World production of lithium minerals was 7800 tonnes in 1988. The main sources are the USSR 42%, and Zimbabwe, China, Canada and Portugal 11% each.

Sodium and potassium are the seventh and eighth most abundant elements by weight in the earth's crust. NaCl and KCl occur in large amounts in sea water. The largest source of sodium is rock salt (NaCl). Various salts including NaCl,  $\text{Na}_2\text{B}_4\text{O}_7 \cdot 10\text{H}_2\text{O}$  (borax),  $(\text{Na}_2\text{CO}_3 \cdot \text{NaHCO}_3 \cdot 2\text{H}_2\text{O})$  (trona),  $\text{NaNO}_3$  (saltpetre) and  $\text{Na}_2\text{SO}_4$  (mirabilite) are obtained from deposits formed by the evaporation of ancient seas such as the Dead Sea and the Great Salt Lake at Utah USA. Sodium chloride is extremely important, and is used in larger tonnages than any other chemical. World production was 179.6 million tonnes in 1988. The main sources are the USA 19%, China 10%, the USSR 9%, India 7%, West Germany 8%, Canada 6%, the UK and Australia 5% each, and France and Mexico 4% each. In most places it is mined as rock salt. In the UK (the Cheshire salt field) about 75% is extracted in solution as brine, and similarly in Germany over 70% is extracted as brine. 'Solar' salt is obtained by evaporating sea water in some hot countries. Ninety-two per cent of the salt produced in India is by evaporation, and 26% of that from Spain and France. This method is also used in Australia.

Potassium occurs mainly as deposits of KCl (sylvite), a mixture of KCl and NaCl (sylvinites), and the double salt  $\text{KCl} \cdot \text{MgCl}_2 \cdot 6\text{H}_2\text{O}$  (carnallite). Soluble potassium salts are collectively called 'potash'. World production of potash was 32.1 million tonnes in 1988, measured as  $\text{K}_2\text{O}$ . The main



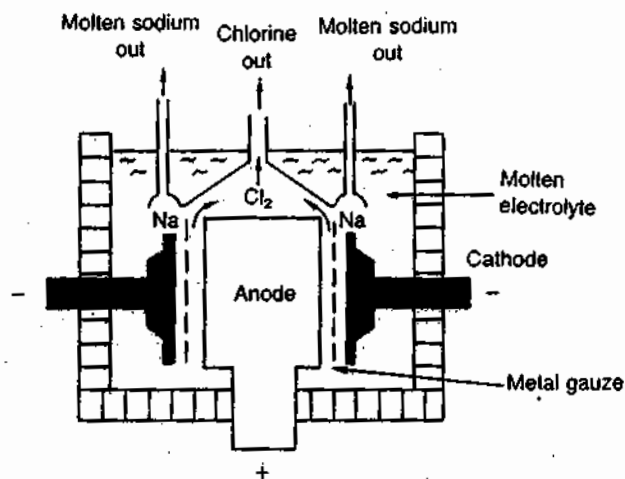

Figure 9.1 Downs cell for the production of sodium.

A Downs cell comprises a cylindrical steel vessel lined with firebrick, measuring about 2.5 m in height and 1.5 m in diameter. The anode is a graphite rod in the middle, and is surrounded by a cast steel cathode. A metal gauze screen separates the two electrodes, and prevents the Na formed at the cathode from recombining with  $\text{Cl}_2$  produced at the anode. The molten sodium rises, as it is less dense than the electrolyte, and it is collected in an inverted trough and removed, and packed into steel drums.

A similar cell can be used to obtain potassium by electrolysis of fused KCl. However, the cell must be operated at a higher temperature because the melting point of KCl is higher, and this results in the vaporization of the liberated potassium. Since sodium is a more powerful reducing agent than potassium and is readily available, the modern method is to reduce molten KCl with sodium vapour at  $850^\circ\text{C}$  in a large fractionating tower. This gives K of 99.5% purity.



Rb and Cs are produced in a similar way by reducing the chlorides with Ca at  $750^\circ\text{C}$  under reduced pressure.

#### USES OF GROUP I METALS AND THEIR COMPOUNDS

Lithium stearate  $\text{C}_{17}\text{H}_{35}\text{COOLi}$  is used in making automobile grease.  $\text{Li}_2\text{CO}_3$  is added to bauxite in the electrolytic production of aluminium, as it lowers the melting point.  $\text{Li}_2\text{CO}_3$  is also used to toughen glass. It also has uses in medicine, as it affects the balance between  $\text{Na}^+$  and  $\text{K}^+$  and  $\text{Mg}^{2+}$  and  $\text{Ca}^{2+}$  in the body. Lithium metal is used to make alloys, for example with lead to make 'white metal' bearings for motor engines,



with aluminium to make aircraft parts which are light and strong, and with magnesium to make armour plate. There is great interest in lithium for thermonuclear purposes, since when bombarded with neutrons it produces tritium (see the section on Nuclear Fusion in Chapter 31). Lithium is also used to make electrochemical cells (both primary and secondary batteries). Primary batteries produce electricity by a chemical change, and are discarded when they 'run down'. These have Li anodes, carbon cathodes and  $\text{SOCl}_2$  as the electrolyte. There is interest in Li/S batteries which could power battery cars in the future, and in secondary cells, which may provide a practical way of storing off-peak electricity. LiH is used to generate hydrogen, and LiOH to absorb  $\text{CO}_2$ .

Caustic soda NaOH is the most important alkali used in industry and is used for a wide variety of purposes including making many inorganic and organic compounds, paper making, neutralizations, and making alumina, soap and rayon. Soda ash  $\text{Na}_2\text{CO}_3$  may be used interchangeably with NaOH in many applications such as making paper, soap and detergents. Large amounts are used in making glass, phosphates, silicates, and cleaning preparations and removing  $\text{SO}_2$  pollution from the flue gases at coal-fired electricity generating stations. Large amounts of  $\text{Na}_2\text{SO}_4$  are used to make paper, detergents and glass. NaOCl is used as a bleach and a disinfectant, and production is about 180 000 tonnes/year.  $\text{NaHCO}_3$  is used in baking powder. Sodium metal is used in large quantities. About 200 000 tonnes/year is produced in the USA alone. Globally about 60% of the Na produced is used to make a Na/Pb alloy which is used to make  $\text{PbEt}_4$  and  $\text{PbMe}_4$  which are used as anti-knock additives to petrol, but this will decrease with the increasing use of lead-free petrol. About 20% is used to reduce  $\text{TiCl}_4$  and  $\text{ZrCl}_4$  to the metals, and the remainder is used to make compounds such as  $\text{Na}_2\text{O}_2$  and NaH. Liquid sodium metal is used as a coolant in one type of nuclear reactor. It is used to transfer heat from the reactor to turbines where it produces steam which is used to generate electricity. Fast breeder nuclear reactors, such as those at Dounreay (Scotland) and Grenoble (France), operate at a temperature of about  $600^\circ\text{C}$ ; being a metal, sodium conducts heat very well, and as its boiling point is  $881^\circ\text{C}$  it is ideal for this purpose. Small amounts of the metal are used in organic synthesis, and for drying organic solvents.

Potassium is an essential element for life. Roughly 95% of potassium compounds are used as fertilizers for plants – KCl 90%,  $\text{K}_2\text{SO}_4$  9%,  $\text{KNO}_3$  1%. Potassium salts are always more expensive than sodium salts, usually by a factor of 10 or more. KOH (which is prepared by electrolysis of aqueous KCl) is used to make potassium phosphates and also soft soap, e.g. potassium stearate, both of which are used in liquid detergents.  $\text{KNO}_3$  is used in explosives.  $\text{KMnO}_4$  is used in the manufacture of saccharin, as an oxidizing agent and for titrations.  $\text{K}_2\text{CO}_3$  is used in ceramics, colour TV tubes and fluorescent light tubes. Potassium superoxide  $\text{KO}_2$  is used in breathing apparatus and in submarines, and KBr is used in photography. Not much potassium metal is produced, and most of it is used to make  $\text{KO}_2$ .

### ELECTRONIC STRUCTURE

Group I elements all have one valency electron in their outer orbital – an  $s$  electron which occupies a spherical orbital. Ignoring the filled inner shells the electronic structures may be written:  $2s^1$ ,  $3s^1$ ,  $4s^1$ ,  $5s^1$ ,  $6s^1$  and  $7s^1$ . The single valence electron is a long distance from the nucleus, is only weakly held and is readily removed. In contrast the remaining electrons are closer to the nucleus, more tightly held, and are removed only with great difficulty. Because of similarities in the electronic structures of these elements, many similarities in chemical behaviour would be expected.

### SIZE OF ATOMS AND IONS

Group I atoms are the largest in their horizontal periods in the periodic table. When the outer electron is removed to give a positive ion, the size decreases considerably. There are two reasons for this.

1. The outermost shell of electrons has been completely removed.
2. Having removed an electron, the positive charge on the nucleus is now greater than the charge on the remaining electrons, so that each of the remaining electrons is attracted more strongly towards the nucleus. This reduces the size further.

Positive ions are always smaller than the parent atom. Even so, the ions are very large, and they increase in size from  $\text{Li}^+$  to  $\text{Fr}^+$  as extra shells of electrons are added.

The  $\text{Li}^+$  is much smaller than the other ions. For this reason, Li only mixes with Na above  $380^\circ\text{C}$ , and it is immiscible with the metals K, Rb and Cs, even when molten; nor will Li form substitutional alloys with them. In contrast the other metals Na, K, Rb and Cs are miscible with each other in all proportions.

### DENSITY

The atoms are large, so Group I elements have remarkably low densities. Lithium metal is only about half as dense as water, whilst sodium and potassium are slightly less dense than water (see Table 9.3). It is unusual

Table 9.3 Size and density

	Metallic radius (Å)	Ionic radius $\text{M}^+$ six-coordinate (Å)	Density ( $\text{g cm}^{-3}$ )
Li	1.52	0.76	0.54
Na	1.86	1.02	0.97
K	2.27	1.38	0.86
Rb	2.48	1.52	1.53
Cs	2.65	1.67	1.90

for metals to have low densities, and in contrast most of the transition metals have densities greater than  $5 \text{ g cm}^{-3}$ , for example iron  $7.9 \text{ g cm}^{-3}$ , mercury  $13.6 \text{ g cm}^{-3}$ , and osmium and iridium (the two most dense elements)  $22.57$  and  $22.61 \text{ g cm}^{-3}$  respectively.

### IONIZATION ENERGY

The first ionization energies for the atoms in this group are appreciably lower than those for any other group in the periodic table. The atoms are very large so the outer electrons are only held weakly by the nucleus: hence the amount of energy needed to remove the outer electron is not very large. On descending the group from Li to Na to K to Rb to Cs, the size of the atoms increases: the outermost electrons become less strongly held, so the ionization energy decreases.

The second ionization energy – that is the energy to remove a second electron from the atoms – is extremely high. The second ionization energy is always larger than the first, often by a factor of two, because it involves removing an electron from a smaller positive ion, rather than from a larger neutral atom. The difference between first and second ionization energies is much larger in this case since in addition it corresponds to removing an electron from a closed shell. A second electron is never removed under normal conditions, as the energy required is greater than that needed to ionize the noble gases. The elements commonly form  $M^+$  ions.

### ELECTRONEGATIVITY AND BOND TYPE

The electronegativity values for the elements in this group are very small – in fact the smallest values of any element. Thus when these elements react with other elements to form compounds, a large electronegativity difference between the two atoms is probable, and ionic bonds are formed.

Na electronegativity	0.9
Cl electronegativity	<u>3.0</u>
Electronegativity difference	<u>2.1</u>

Table 9.4 Ionization energies

	First ionization energy ( $\text{kJ mol}^{-1}$ )	Second ionization energy ( $\text{kJ mol}^{-1}$ )
Li	520.1	7296
Na	495.7	4563
K	418.6	3069
Rb	402.9	2650
Cs	375.6	2420

Table 9.5 Electronegativity values

	Pauling's electronegativity
Li	1.0
Na	0.9
K	0.8
Rb	0.8
Cs	0.7

An electronegativity difference of approximately 1.7–1.8 corresponds to 50% ionic character. The value 2.1 exceeds this, so the bonding in NaCl is predominantly ionic. Similar arguments apply to other compounds: for example, the electronegativity difference in LiF is 3.0, and in KBr is 2.0, and both compounds are ionic.

The chemistry of the alkali metals is largely that of their ions.

#### BORN-HABER CYCLE: ENERGY CHANGES IN THE FORMATION OF IONIC COMPOUNDS

When elements react to form compounds,  $\Delta G$  (the free energy of formation) is negative. For a reaction to proceed spontaneously, the free energy of the products must be lower than that of the reactants.

Usually the energy changes are measured as enthalpy values  $\Delta H$ , and  $\Delta G$  is related to  $\Delta H$  by the equation:

$$\Delta G = \Delta H - T\Delta S$$

In many cases enthalpy values are used instead of free energy values, and the two are almost the same if the term  $T\Delta S$  is small. At room temperature  $T$  is almost 300 K, so  $\Delta G$  and  $\Delta H$  are only similar when the change in entropy  $\Delta S$  is very small. Entropy changes are large when there is a change in physical state, e.g. solid to liquid, or liquid to gas, but otherwise entropy changes are usually small.

A whole series of energy changes is involved when one starts from the elements and finishes with an ionic crystal. These changes are shown in the Born-Haber cycle (Figure 9.2). The cycle serves two purposes. First it explains how these various energy changes are related, and second, if all but one of the terms can be measured, then the remaining value can be calculated. There is no direct way of obtaining electron affinity values, and these have been calculated from this type of energy cycle.

Hess's law states that the energy change occurring during a reaction depends only on the energy of the initial reactants and the energy of the final products, and not on the reaction mechanism, or the route taken. Thus, by Hess's law, the energy change for the reaction of solid sodium and chlorine gas to form a sodium chloride crystal by the direct route (measured as the enthalpy of formation) must be the same as the sum of

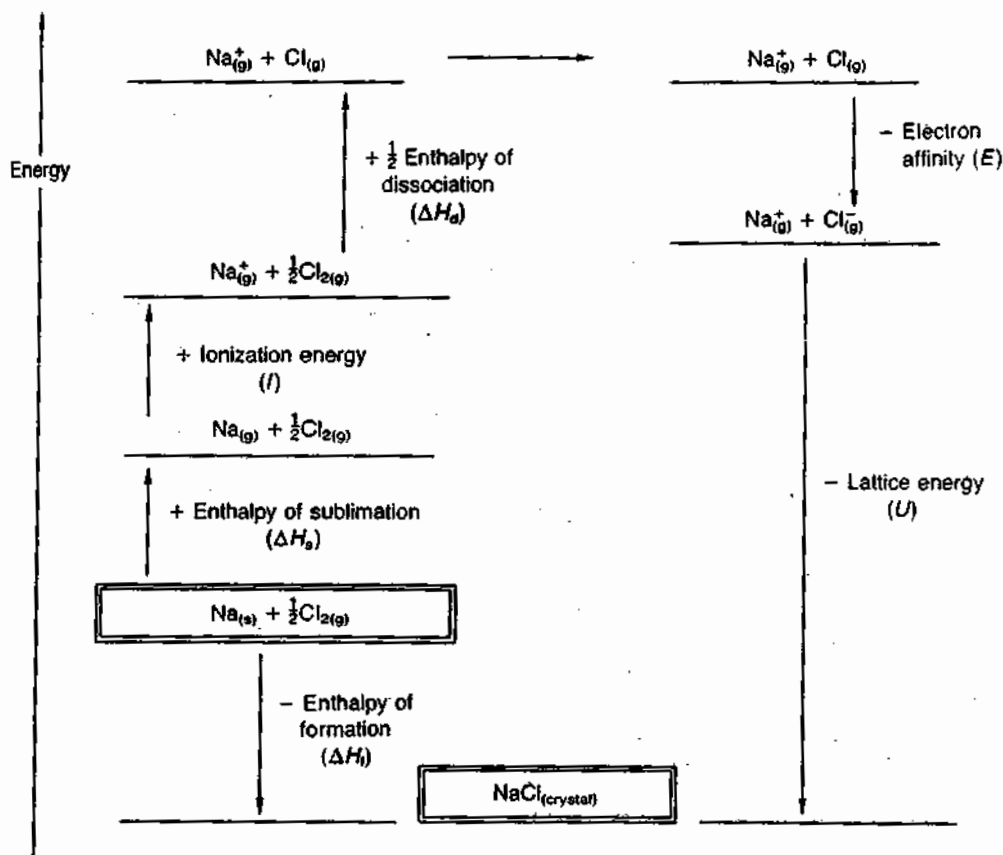

Figure 9.2 Born-Haber cycle for the formation of NaCl.

all the energy changes going round the cycle by the long route, i.e. by producing first gaseous atoms of the elements, then gaseous ions, and finally packing these to give the crystalline solid. This may be expressed as:

$$-\Delta H_f = +\Delta H_s + I + \frac{1}{2}\Delta H_d - E - U$$

Details of these energy terms are shown in Table 9.6. A considerable amount of energy (the enthalpies of sublimation and dissociation, and

Table 9.6 Enthalpy ( $\Delta H$ ) values for MCl (all values in  $\text{kJ mol}^{-1}$ )

	Sublimation energy $M_{(s)} - M_{(g)}$	$\frac{1}{2}$ enthalpy of dissociation $\frac{1}{2}\text{Cl}_2 - \text{Cl}$	Ionization energy $M - M^+$	Electron affinity $\text{Cl} - \text{Cl}^-$	Lattice energy	Total = enthalpy of formation
Li	161	121.5	520	-355	-845	-397.5
Na	108	121.5	496	-355	-770	-399.5
K	90	121.5	419	-355	-703	-427.5
Rb	82	121.5	403	-355	-674	-422.5
Cs	78	121.5	376	-355	-644	-423.5

the ionization energy) is used to produce the ions, so these terms are positive. Ionic solids are formed because an even larger amount of energy is evolved, mainly coming from the lattice energy and to a smaller extent from the electron affinity, resulting in a negative value for the enthalpy of formation  $\Delta H_f$ .

All the halides  $MX$  have negative enthalpies of formation, which indicates that thermodynamically (that is in terms of energy) it is feasible to form the compounds  $MX$  from the elements. The values are shown in Table 9.7. Several trends are apparent in these values:

1. The most negative enthalpies of formation occur with the fluorides. For any given metal, the values decrease in the sequence fluoride > chloride > bromide > iodide. Thus the fluorides are the most stable, and the iodides the least stable.
2. The enthalpies of formation for the chlorides, bromides and iodides become more negative on descending the group. This trend is observed with most salts, but the opposite trend is found in the fluorides.

Ionic compounds may also be formed in solution, when a similar cycle of energy changes must be considered, but the hydration energies of the positive and negative ions must be substituted for the lattice energy.

The energy cycle shown in Figure 9.3 is very similar to the Born-Haber cycle. The enthalpy of formation of hydrated ions from the elements in their natural state must be equal to the sum of all the other energy changes going round the cycle.

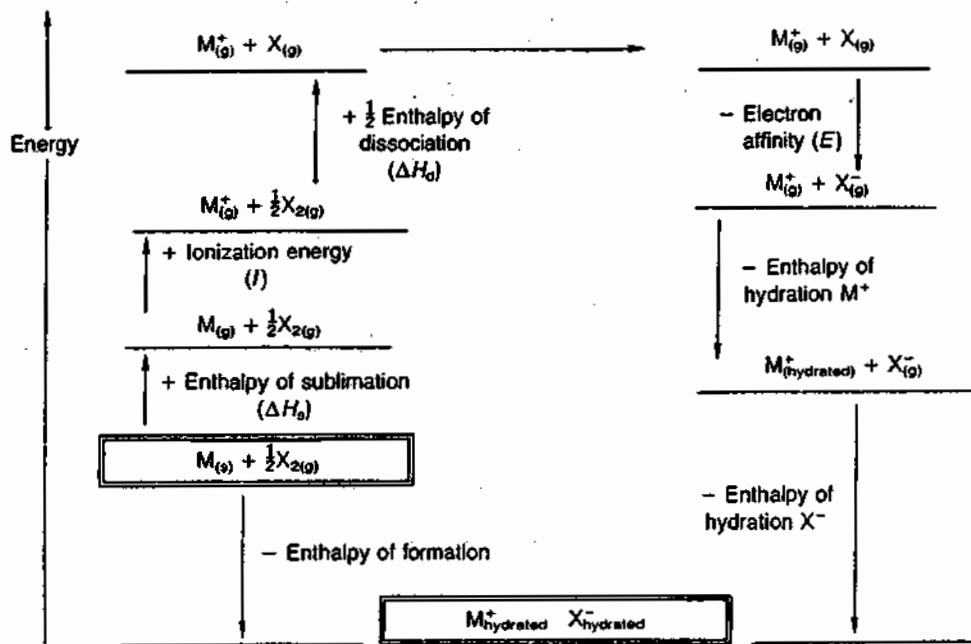

Figure 9.3 Energy cycle for the hydration of ions.

**Table 9.7** Standard enthalpies of formation for Group I halides (all values in  $\text{kJ mol}^{-1}$ )

	MF	MCl	MBr	MI
Li	-612	-398	-350	-271
Na	-569	-400	-360	-288
K	-563	-428	-392	-328
Rb	-549	-423	-389	-329
Cs	-531	-424	-395	-337

### STRUCTURES OF THE METALS, HARDNESS, AND COHESIVE ENERGY

At normal temperatures all the Group I metals adopt a body-centred cubic type of lattice with a coordination number of 8. However, at very low temperatures lithium forms a hexagonal close-packed structure with a coordination number of 12.

The metals are all very soft, and can be cut quite easily with a knife. Lithium is harder than the others, but is softer than lead. Bonding in metals is discussed in Chapters 2 and 5 in terms of delocalized molecular orbitals or bands, extending over the whole crystal.

The cohesive energy is the force holding the atoms or ions together in the solid. (This is the same in magnitude, but the opposite in sign, to the enthalpy of atomization, which is the energy required to break the solid up into gaseous atoms.) The cohesive energies of Group I metals are about half of those for Group II, and one third of those for Group III elements. The magnitude of the cohesive energy determines the hardness, and it depends on the number of electrons that can participate in bonding and on the strength of the bonds formed. The softness, low cohesive energy and weak bonding in Group I elements are consequences of these metals having only one valency electron which can participate in bonding (compared with two or more electrons in most other metals), and of the large size and diffuse nature of the outer bonding electron. The atoms become larger on descending the group from lithium to caesium, so the bonds are weaker, the cohesive energy decreases and the softness of the metals increases.

**Table 9.8** Cohesive energy

	Cohesive energy (Enthalpy of atomization) ( $\text{kJ mol}^{-1}$ )
Li	161
Na	108
K	90
Rb	82
Cs	78

### MELTING AND BOILING POINTS

The generally low values for cohesive energy are reflected in the very low values of melting and boiling points in the group. The cohesive energy decreases down the group, and the melting points decrease correspondingly.

The melting points range from lithium 181 °C to caesium 28.5 °C. These are extremely low values for metals, and contrast with the melting points of the transition metals, most of which are above 1000 °C.

The melting point of lithium is nearly twice as high (in °C) as that for sodium, though the others are close together. With many properties it is found that the first element in each group differs appreciably from the rest of the group. (Differences between lithium and the other Group I elements are discussed near the end of this chapter.)

**Table 9.9** Melting and boiling points

	Melting point (°C)	Boiling point (°C)
Li	181	1347
Na	98	881
K	63	766
Rb	39	688
Cs	28.5	705

### FLAME COLOURS AND SPECTRA

A result of the low ionization energies is that when these elements are irradiated with light, the light energy absorbed may be sufficient to make an atom lose an electron. Electrons emitted in this way are called photoelectrons, and this explains the use of caesium and potassium as cathodes in photoelectric cells.

Electrons may also be quite readily excited to a higher energy level, for example in the flame test. To perform this test, a sample of the metal chloride, or any salt of the metal moistened with concentrated HCl, is heated on a platinum or nichrome wire in a Bunsen burner flame. The heat from the burner excites one of the orbital electrons to a higher energy

**Table 9.10** Flame colours and wavelengths

	Colour	Wavelength (nm)	Wavenumber (cm <sup>-1</sup> )
Li	crimson	670.8	14 908
Na	yellow	589.2	16 972
K	lilac	766.5	13 046
Rb	red-violet	780.0	12 821
Cs	blue	455.5	21 954



level. When the excited electron drops back to its original energy level it gives out the extra energy it obtained. The energy  $E$  is related to the wave number  $\nu$  by the Einstein relationship:

$$E = h\nu \text{ (where } h \text{ is Planck's constant)}$$

For Group I metals, the energy emitted appears as visible light, thus giving the characteristic flame colorations.

The colour actually arises from electronic transitions in short-lived species which are formed momentarily in the flame. The flame is rich in electrons, and in the case of sodium the ions are temporarily reduced to atoms.

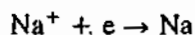

The sodium D-line (which is actually a doublet at 589.0 nm and 589.6 nm) arises from the electronic transition  $3s^1 \rightarrow 3p^1$  in sodium atoms formed in the flame. The colours from different elements do not all arise from the same transition, or from the same species. Thus the red line for lithium arises from a short-lived LiOH species formed in the flame.

These characteristic flame colorations of the *emission spectra* are used for the analytical determination of these elements by flame photometry. A solution of a Group I salt is aspirated into an oxygen-gas flame in a flame photometer. The energy from the flame excites an electron to a higher energy level, and when it falls back to the lower energy level the extra energy is given out as light. The intensity of the flame coloration is measured with a photoelectric cell. The intensity depends on the concentration of metal present. A calibration graph is produced by measuring intensities with known standard solutions, and the exact concentration of the unknown solution can be found by comparison with the standard graph.

Alternatively *atomic absorption spectroscopy* may be used to estimate Group I metals. Here a lamp that emits a wavelength appropriate for a particular electronic transition is used to irradiate the sample in the flame. Thus a sodium lamp is used to detect sodium in the sample: other lamps are used to detect other elements. The amount of light absorbed, this time by the ground state atoms, is measured, and is proportional to the amount of the particular element being tested for.

## COLOUR OF COMPOUNDS

Colour arises because the energy absorbed or emitted in electronic transitions corresponds to a wavelength in the visible region. The Group I metal ions all have noble gas configurations in which all the electrons are paired. Thus promoting an electron requires some energy to unpair an electron, some to break a full shell of electrons and some to promote the electron to a higher level. The total energy is large: hence there are no suitable transitions and the compounds are typically white. Any transitions which do occur will be of high energy, will appear in the ultraviolet region rather than in the visible region, and will be invisible to the human eye. Com-

pounds of Group I metals are typically white, except those where the anion is coloured, for example sodium chromate  $\text{Na}_2[\text{CrO}_4]$  (yellow), potassium dichromate  $\text{K}_2[\text{Cr}_2\text{O}_7]$  (orange), and potassium permanganate  $\text{K}[\text{MnO}_4]$  (deep purple). In these cases the colour comes from the anions  $[\text{CrO}_4]^-$ ,  $[\text{Cr}_2\text{O}_7]^{2-}$  or  $[\text{MnO}_4]^-$  and not from the Group I metal ion.

When Group I elements form compounds (usually ionic, but there are a few covalent compounds), all the electrons are paired. Because of this Group I compounds are diamagnetic. There is one notable exception – the superoxides, which are discussed later.

### CHEMICAL PROPERTIES

Table 9.11 Some reactions of Group I metals

Reaction	Comment
$\text{M} + \text{H}_2\text{O} \rightarrow \text{MOH} + \text{H}_2$	The hydroxides are the strongest bases known
with excess oxygen $\text{Li} + \text{O}_2 \rightarrow \text{Li}_2\text{O}$	Monoxide is formed by Li and to a small extent by Na
$\text{Na} + \text{O}_2 \rightarrow \text{Na}_2\text{O}_2$	Peroxide formed by Na and to a small extent by Li
$\text{K} + \text{O}_2 \rightarrow \text{KO}_2$	Superoxide formed by K, Rb, Cs
$\text{M} + \text{H}_2 \rightarrow \text{MH}$	Ionic 'salt-like' hydrides
$\text{Li} + \text{N}_2 \rightarrow \text{Li}_3\text{N}$	Nitride formed only by Li
$\text{M} + \text{P} \rightarrow \text{M}_3\text{P}$	All the metals form phosphides
$\text{M} + \text{As} \rightarrow \text{M}_3\text{As}$	All the metals form phosphides
$\text{M} + \text{Sb} \rightarrow \text{M}_3\text{Sb}$	All the metals form phosphides
$\text{M} + \text{S} \rightarrow \text{M}_2\text{S}$	All the metals form sulphides
$\text{M} + \text{Se} \rightarrow \text{M}_2\text{Se}$	All the metals form selenides
$\text{M} + \text{Te} \rightarrow \text{M}_2\text{Te}$	All the metals form tellurides
$\text{M} + \text{F}_2 \rightarrow \text{MF}$	All the metals form fluorides
$\text{M} + \text{Cl}_2 \rightarrow \text{MCl}$	All the metals form chlorides
$\text{M} + \text{Br}_2 \rightarrow \text{MBr}$	All the metals form bromides
$\text{M} + \text{I}_2 \rightarrow \text{MI}$	All the metals form iodides
$\text{M} + \text{NH}_3 \rightarrow \text{MNH}_2$	All the metals form amides

#### Reaction with water

Group I metals all react with water, liberating hydrogen and forming the hydroxides. The reaction becomes increasingly violent on descending the group. Thus lithium reacts gently, sodium melts on the surface of the

water and the molten metal skates about vigorously and may catch fire (especially if localized), and potassium melts and always catches fire.

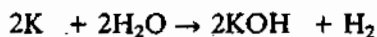
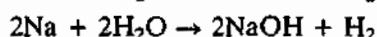
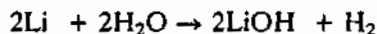

The standard electrode potentials  $E^\circ$  are  $\text{Li}^+|\text{Li} = -3.05$  volts,  $\text{Na}^+|\text{Na} = -2.71$ ,  $\text{K}^+|\text{K} = -2.93$ ,  $\text{Rb}^+|\text{Rb} = -2.92$ ,  $\text{Cs}^+|\text{Cs} = -2.92$ . Lithium has the most negative standard electrode potential of any element in the periodic table, largely because of its high hydration energy. Standard electrode potentials  $E^\circ$  and Gibbs free energy  $\Delta G$  are related by the equation:

$$\Delta G = -nFE^\circ$$

where  $n$  is the number of electrons removed from the metal to produce the ion, and  $F$  is the Faraday constant.

The reaction  $\text{Li}^+ + e \rightarrow \text{Li}$  has the largest negative  $E^\circ$  value, and hence the largest positive  $\Delta G$  value. Thus the reaction does not occur. However, the reverse reaction  $\text{Li} \rightarrow \text{Li}^+ + e$  has a large negative value of  $\Delta G$ , so lithium liberates more energy than the other metals when it reacts with water. In view of this it is at first sight rather surprising that lithium reacts gently with water, whereas potassium, which liberates less energy, reacts violently and catches fire. The explanation lies in the kinetics (that is the rate at which the reaction proceeds), rather than in the thermodynamics (that is the total amount of energy liberated). Potassium has a low melting point, and the heat of reaction is sufficient to make it melt, or even vaporize. The molten metal spreads out, and exposes a larger surface to the water, so it reacts even faster, gets even hotter and catches fire.

#### Reaction with air

Chemically Group I elements are very reactive, and tarnish rapidly in dry air. Sodium, potassium, rubidium and caesium form oxides of various types, but lithium forms a mixture of the oxide and the nitride,  $\text{Li}_3\text{N}$ .

#### Reaction with nitrogen

Lithium is the only element in the group that reacts with nitrogen to form a nitride. Lithium nitride,  $\text{Li}_3\text{N}$ , is ionic ( $3\text{Li}^+$  and  $\text{N}^{3-}$ ), and is ruby red. Two reactions of the nitride are of interest. First, on heating to a high temperature it decomposes to the elements, and second, it reacts with water, giving ammonia.

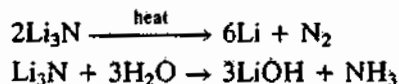

## OXIDES, HYDROXIDES, PEROXIDES AND SUPEROXIDES

## Reaction with air

The metals all burn in air to form oxides, though the the product varies depending on the metal. Lithium forms the monoxide  $\text{Li}_2\text{O}$  (and some peroxide  $\text{Li}_2\text{O}_2$ ), sodium forms the peroxide  $\text{Na}_2\text{O}_2$  (and some monoxide  $\text{Na}_2\text{O}$ ), and the others form superoxides of the type  $\text{MO}_2$ .

All five metals can be induced to form the normal oxide, peroxide or superoxide by dissolving the metal in liquid ammonia and bubbling in the appropriate amount of oxygen.

## Normal oxides – monoxides

The monoxides are ionic, for example  $2\text{Li}^+$  and  $\text{O}^{2-}$ .  $\text{Li}_2\text{O}$  and  $\text{Na}_2\text{O}$  are pure white solids as expected, but surprisingly  $\text{K}_2\text{O}$  is pale yellow,  $\text{Rb}_2\text{O}$  is bright yellow and  $\text{Cs}_2\text{O}$  is orange. Metallic oxides are usually basic. The typical oxides  $\text{M}_2\text{O}$  are strongly basic oxides, and they react with water, forming strong bases.

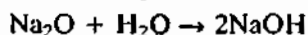

The crystal structures of  $\text{Li}_2\text{O}$ ,  $\text{Na}_2\text{O}$ ,  $\text{K}_2\text{O}$  and  $\text{Rb}_2\text{O}$  are anti-fluorite structures. The anti-fluorite structure is like that for fluorite  $\text{CaF}_2$ , except that the positions of the positive and negative ions are interchanged. Thus  $\text{Li}^+$  fill the sites occupied by  $\text{F}^-$ , and  $\text{O}^{2-}$  fill sites occupied by  $\text{Ca}^{2+}$ .  $\text{Cs}_2\text{O}$  has an anti- $\text{CdCl}_2$  layer structure.

## Hydroxides

Sodium hydroxide  $\text{NaOH}$  is often called caustic soda, and potassium hydroxide is called caustic potash, because of their corrosive properties (for example on glass or on skin). These caustic alkalis are the strongest bases known in aqueous solution. The hydroxides of Na, K, Rb and Cs are very soluble in water, but  $\text{LiOH}$  is much less soluble (see Table 9.12). At

Table 9.12 Solubility of Group I hydroxides

Element	Solubility (g/100 g $\text{H}_2\text{O}$ )
Li	13.0 (25 °C)
Na	108.3 (25 °C)
K	112.8 (25 °C)
Rb	197.6 (30 °C)
Cs	385.6 (15 °C)

25°C a saturated solution of NaOH is about 27 molar, whilst saturated LiOH is only about 5 molar.

The bases react with acids to form salts and water, and are used for many neutralizations.

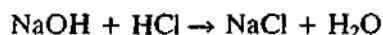

The bases also react with  $\text{CO}_2$ , even traces in the air, forming the carbonate. LiOH is used to absorb carbon dioxide enclosed environments such as space capsules (where its light weight is an advantage in reducing the launching weight).

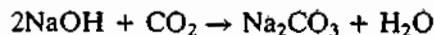

They also react with the amphoteric oxides,  $\text{Al}_2\text{O}_3$ , forming aluminates,  $\text{SiO}_2$  (or glass), forming silicates,  $\text{SnO}_2$ , forming stannates,  $\text{PbO}_2$ , forming plumbates and  $\text{ZnO}$ , forming zincates.

The bases liberate ammonia from both ammonium salts and coordination complexes where ammonia is attached to a transition metal ion (ammine complexes).

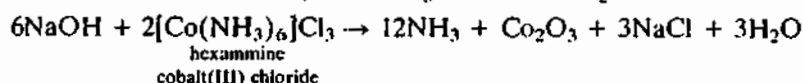
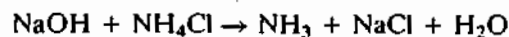

NaOH reacts with  $\text{H}_2\text{S}$  to form sulphides  $\text{S}^{2-}$ , and hydrogen sulphides  $\text{SH}^-$ , and it is used to remove mercaptans from petroleum products.

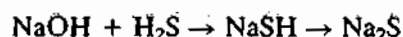

The hydroxides react with alcohols, forming alkoxides.

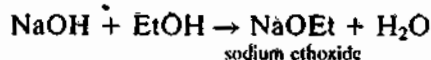

KOH resembles NaOH in all its reactions, but as KOH is much more expensive it is seldom used. However, KOH is much more soluble in alcohol, thus producing  $\text{OC}_2\text{H}_5^-$  ions by the equilibrium

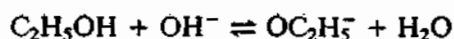

This accounts for the use of alcoholic KOH in organic chemistry. Group I hydroxides are thermally stable, illustrating the strong electropositive nature of the metals. On heating, many hydroxides decompose, losing water and forming the oxide.

#### Peroxides and superoxides

The peroxides all contain the  $[\text{—O—O—}]^{2-}$  ion. They are diamagnetic (all the electrons are paired), and are oxidizing agents. They may be regarded as salts of the dibasic acid  $\text{H}_2\text{O}_2$ , and they react with water and acid, giving hydrogen peroxide  $\text{H}_2\text{O}_2$ .

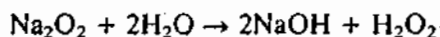

$\text{Na}_2\text{O}_2$  is pale yellow in colour. It is used industrially for bleaching wood pulp, paper and fabrics such as cotton and linen. It is a powerful oxidant, and many of its reactions are dangerously violent, particularly with materials that are reducing agents such as aluminium powder, charcoal, sulphur and many organic liquids. Because it reacts with  $\text{CO}_2$  in the air it has been used to purify the air in submarines and confined spaces, as it both removes  $\text{CO}_2$  and produces  $\text{O}_2$ . Potassium superoxide  $\text{KO}_2$  is even better for this purpose. Some typical reactions are:

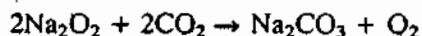
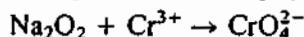

The industrial process for forming sodium peroxide is a two-stage reaction in the presence of excess air:

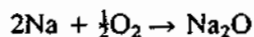

The superoxides contain the ion  $[\text{O}_2]^-$ , which has an unpaired electron, and hence they are paramagnetic and are all coloured ( $\text{LiO}_2$  and  $\text{NaO}_2$  yellow,  $\text{KO}_2$  orange,  $\text{RbO}_2$  brown and  $\text{CsO}_2$  orange).

$\text{NaO}_2$  has three different crystal structures, the marcasite structure at liquid air temperatures, the pyrites structure  $\text{FeS}_2$  between  $-77^\circ\text{C}$  and  $-50^\circ\text{C}$ , and a calcium carbide  $\text{CaC}_2$  structure at room temperature. Both the pyrites and calcium carbide structures are related to the  $\text{NaCl}$  structure in that the metal ions occupy the  $\text{Na}^+$  sites, and  $\text{O}_2^-$ ,  $\text{S}_2^{2-}$  and  $\text{C}_2^{2-}$  ions are centred on the  $\text{Cl}^-$  sites. Since the negative ions contain two atoms, their shape is an elongated rod rather than a sphere. In the  $\text{CaC}_2$  structure, the  $\text{C}_2^{2-}$  ions are all oriented along one of the cubic axes, and thus the unit cell is elongated in that direction: hence the unit cell is cubic in  $\text{NaCl}$  but tetragonal in  $\text{CaC}_2$ . The pyrites structure is similar, but the  $\text{C}_2^{2-}$  ions are not all in alignment, and the cubic structure is retained.

Superoxides are even stronger oxidizing agents than peroxides, and give both  $\text{H}_2\text{O}_2$  and  $\text{O}_2$  with either water or acids.



$\text{KO}_2$  is used in space capsules, submarines, and breathing masks, because it both produces oxygen and removes carbon dioxide. Both functions are important in life support systems.

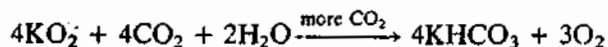

Sodium superoxide cannot be prepared by burning the metal in oxygen at atmospheric pressure, but it is made commercially and in good yields by reacting sodium peroxide with oxygen at a high temperature and pressure (450°C and 300 atmospheres) in a stainless steel bomb.

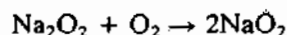

The bonding in peroxides and superoxides is described in the examples of molecular orbital treatment in Chapter 4. The peroxide ion  $[\text{—O—O—}]^{2-}$  has 18 electrons, which occupy the molecular orbitals as shown:

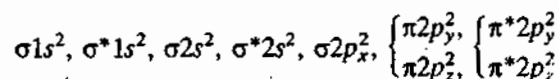

increasing energy  
→

Thus the bond order is one, corresponding to a single bond.

The superoxide ion  $[\text{O}_2]^-$  has only 17 electrons, which give a bond order of 1.5.

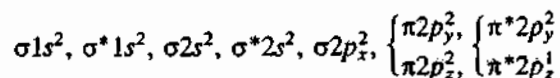

Generally, large atoms or ions form weaker bonds than small ones. The peroxide and superoxide ions are large, and it is noteworthy that the stability of the peroxides and superoxides increases as the metal ions become larger. This shows that large cations can be stabilized by large anions, since if both ions are similar in size the coordination number will be high, and this gives a high lattice energy.

## SULPHIDES

The metals all react with sulphur, forming sulphides such as  $\text{Na}_2\text{S}$ , and polysulphides  $\text{Na}_2\text{S}_n$  where  $n = 2, 3, 4, 5$  or  $6$ . The polysulphide ions are made from zig-zag chains of sulphur atoms.

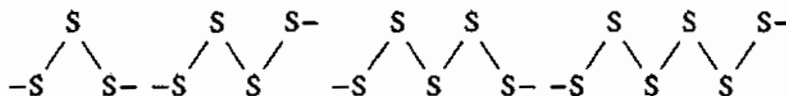

Sodium sulphide can also be made by heating sodium sulphate with carbon, or by passing  $\text{H}_2\text{S}$  into  $\text{NaOH}$  solution.

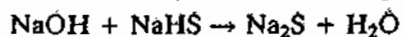
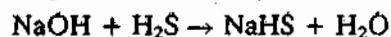
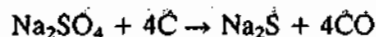

Group I sulphides hydrolyse appreciably in water, giving strongly alkaline solutions:

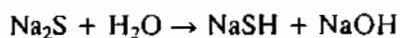

$\text{Na}_2\text{S}$  is used to make organic sulphur dyestuffs, and in the leather industry to remove hair from hides.  $\text{Na}_2\text{S}$  is readily oxidized by air to form sodium thiosulphate, which is used in photography to dissolve silver halides, and as a laboratory reagent for iodine titrations.

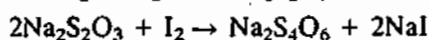
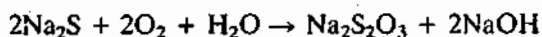

### SODIUM HYDROXIDE

Sodium hydroxide is the most important alkali used in industry. It is produced on a large scale (34 million tonnes in 1985) by the electrolysis of an aqueous solution of  $\text{NaCl}$  (brine) using either a diaphragm cell or a mercury cathode cell. At one time it was also made from  $\text{Na}_2\text{CO}_3$  by the lime-caustic soda process, but this is only used a little nowadays as other methods are cheaper. Details of the industrial methods, uses, and tonnages are given in Chapter 10.

### SODIUM HYDROGENCARBONATE (SODIUM BICARBONATE)

About 200 000 tonnes of  $\text{NaHCO}_3$  are produced annually in the USA, of which 40% is used for baking powder, 15% to make other chemicals, 12% in pharmaceutical products including anti-acid preparations for indigestion, and 10% in fire extinguishers.

$\text{NaHCO}_3$  can be used on its own to make cakes or bread 'rise' since it decomposes between  $50^\circ\text{C}$  and  $100^\circ\text{C}$ , giving bubbles of  $\text{CO}_2$ .

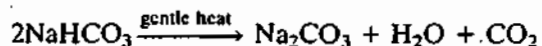

Baking powder is more commonly used, and contains  $\text{NaHCO}_3$ ,  $\text{Ca}(\text{H}_2\text{PO}_4)_2$  and starch. The  $\text{Ca}(\text{H}_2\text{PO}_4)_2$  is acidic and when moistened it reacts with  $\text{NaHCO}_3$ , giving  $\text{CO}_2$ . The starch is a filler. An improved 'combination baking powder' contains about 40% starch, 30%  $\text{NaHCO}_3$ , 20%  $\text{NaAl}(\text{SO}_4)_2$  and 10%  $\text{Ca}(\text{H}_2\text{PO}_4)_2$ . The  $\text{NaAl}(\text{SO}_4)_2$  slows the reaction down so the  $\text{CO}_2$  is given off more slowly.

### SODIUM SULPHATE

About 4.2 million tonnes of  $\text{Na}_2\text{SO}_4$  are used annually. About 55% of this is made synthetically, as a by-product from the manufacture of  $\text{HCl}$ , and also from many neutralization processes that use  $\text{H}_2\text{SO}_4$ . About 45%, mainly Glauber's salt  $\text{Na}_2\text{SO}_4 \cdot 10\text{H}_2\text{O}$ , is mined.

The major use of  $\text{Na}_2\text{SO}_4$  - some 70% - is in the paper industry, and about 10% is used in detergents, and 10% in glass manufacture. In the Kraft paper making process, a strong alkaline solution of  $\text{Na}_2\text{SO}_4$  is used to dissolve the lignin that holds the cellulose fibres together in wood chips.



The cellulose fibres are then turned into corrugated cardboard and brown paper.

### OXOSALTS – CARBONATES, BICARBONATES, NITRATES AND NITRITES

Group I metals are highly electropositive and thus form very strong bases, and have quite stable oxosalts.

The carbonates are remarkably stable, and will melt before they eventually decompose into oxides at temperatures above 1000°C.  $\text{Li}_2\text{CO}_3$  is considerably less stable and decomposes more readily.

Because Group I metals are so strongly basic, they also form solid bicarbonates (also called hydrogencarbonates). No other metals form solid bicarbonates, though  $\text{NH}_4\text{HCO}_3$  also exists as a solid. Bicarbonates evolve carbon dioxide and turn into carbonates on gentle warming. This is one test for bicarbonates in qualitative analysis. The crystal structures of  $\text{NaHCO}_3$  and  $\text{KHCO}_3$  both show hydrogen bonding, but are different. In  $\text{NaHCO}_3$  the  $\text{HCO}_3^-$  ions are linked into an infinite chain, whilst in  $\text{KHCO}_3$  a dimeric anion is formed.

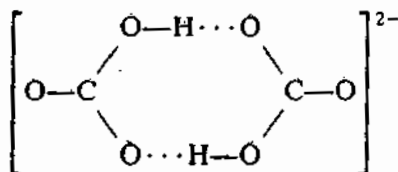

Lithium is exceptional in that it does not form a solid bicarbonate, though  $\text{LiHCO}_3$  can exist in solution. All the carbonates and bicarbonates are soluble in water.

Over 50 000 tonnes of  $\text{Li}_2\text{CO}_3$  are produced annually. Most of it is added as an impurity to  $\text{Al}_2\text{O}_3$  to lower its melting point in the extraction of aluminium by electrolysis. Some is used to toughen glass (sodium in the glass is replaced by lithium).  $\text{Na}_2\text{CO}_3$  is used as washing soda to soften water in hard water areas, and  $\text{NaHCO}_3$  is used as baking powder.

The nitrates can all be prepared by the action of  $\text{HNO}_3$  on the corresponding carbonate or hydroxide, and they are all very soluble in water.  $\text{LiNO}_3$  is used for fireworks and red-coloured distress flares. Large deposits of  $\text{NaNO}_3$  are found in Chile, and are used as a nitrogenous fertilizer. Solid  $\text{LiNO}_3$  and  $\text{NaNO}_3$  are deliquescent, and because of this  $\text{KNO}_3$  is used in preference to  $\text{NaNO}_3$  in gunpowder (gunpowder is a mixture of  $\text{KNO}_3$ , sulphur and charcoal).  $\text{KNO}_3$  is usually obtained from synthetic nitric acid and  $\text{K}_2\text{CO}_3$ , but at one time it was made from  $\text{NaNO}_3$ :

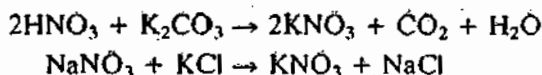

Group I nitrates are fairly low melting solids, and are amongst the most stable nitrates known. However, on strong heating they decompose into

nitrites, and at higher temperatures to the oxide.  $\text{LiNO}_3$  decomposes more readily than the others, forming the oxide.

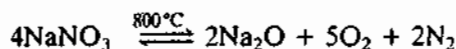
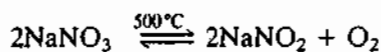

- Alkali metal nitrates are widely used as molten salts as a solvent in which to carry out high temperature oxidations, and also as a heat transfer medium. They are used up to around  $600^\circ\text{C}$ , but molten salt baths are often used at much lower temperatures. For example, a 1:1 mixture of  $\text{LiNO}_3/\text{KNO}_3$  melts at the surprisingly low temperature of  $125^\circ\text{C}$ .

Nitrites are important in the manufacture of organonitrogen compounds, the most important being the azo dyes. Small amounts of  $\text{NaNO}_2$  are used in molten salt baths with  $\text{NaNO}_3$ , and some is used as a food preservative. Nitrites are easily recognized in the laboratory, because on treatment with dilute acids they produce brown fumes of  $\text{NO}_2$ .

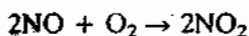

$\text{NaNO}_2$  is manufactured by absorbing oxides of nitrogen in  $\text{Na}_2\text{CO}_3$  solution.



They can also be made by thermal decomposition of nitrates and the chemical reduction of nitrates:

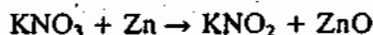
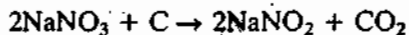

or by reacting  $\text{NO}$  with a hydroxide.



### HALIDES AND POLYHALIDES

Since  $\text{Li}^+$  is the smallest ion in the group, it would be expected to form hydrated salts more readily than the other metals.  $\text{LiCl}$ ,  $\text{LiBr}$  and  $\text{LiI}$  form trihydrates  $\text{LiX} \cdot 3\text{H}_2\text{O}$ , but the other alkali metal halides form anhydrous crystals.

All the halides adopt a  $\text{NaCl}$  type of structure with a coordination number of 6 except for  $\text{CsCl}$ ,  $\text{CsBr}$  and  $\text{CsI}$ . The latter have a  $\text{CsCl}$  type of structure with a coordination number of 8. Rather more compounds adopt the  $\text{NaCl}$  type of structure than would be expected from the radius ratios of the ions  $r^+/r^-$ , and the reason for this structure being adopted is that it gives the highest lattice energy (see the sections on Ionic compounds of the type  $\text{AX}$ , and Lattice energy in Chapter 3).

The alkali metal halides react with the halogens and interhalogen compounds forming ionic polyhalide compounds:

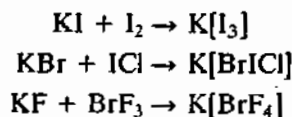

## HYDRIDES

Group I metals all react with hydrogen, forming ionic or salt-like hydrides  $\text{M}^+\text{H}^-$ . However, the ease with which they do so decreases from lithium to caesium. These hydrides contain the  $\text{H}^-$  ion (which is not commonly found, since hydrogen usually forms  $\text{H}^+$  ions). It can be proved that  $\text{H}^-$  ions exist because on electrolysis hydrogen is liberated at the anode.

The hydrides react with water, liberating hydrogen, and lithium hydride is used as a source of hydrogen for military purposes and for filling meteorological balloons.

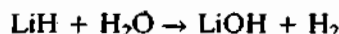

Lithium also forms a complex hydride  $\text{Li[AlH}_4\text{]}$ , called lithium aluminium hydride, which is a useful reducing agent. It is made from lithium hydride in dry ether solution.

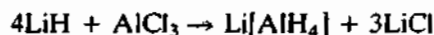

Lithium aluminium hydride is ionic, and the  $[\text{AlH}_4]^-$  ion is tetrahedral.  $\text{Li[AlH}_4\text{]}$  is a powerful reducing agent and is widely used in organic chemistry, as it reduces carbonyl compounds to alcohols. It reacts violently with water, so it is necessary to use absolutely dry organic solvents, for example ether which has been dried over sodium.  $\text{Li[AlH}_4\text{]}$  will also reduce a number of inorganic compounds.

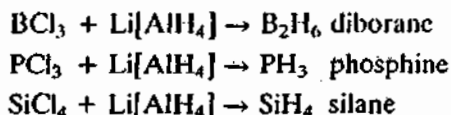

Sodium tetrahydridoborate (sodium borohydride)  $\text{Na[BH}_4\text{]}$  is another hydride complex. It is ionic, comprising tetrahedral  $[\text{BH}_4]^-$  ions. It is best obtained by heating sodium hydride with trimethyl borate:

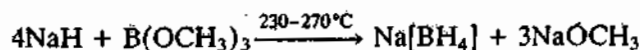

Other tetrahydridoborates for Group I and II metals, aluminium and some transition metals can be made from the sodium salt. These tetrahydridoborates are used as reducing agents, and the alkali metal compounds (particularly those of Na and K) are becoming increasingly used as they are much less sensitive to water than  $\text{Li[AlH}_4\text{]}$ . Thus  $\text{Na[BH}_4\text{]}$  can be crystallized from cold water, and  $\text{K[BH}_4\text{]}$  from hot water, so they

have the advantage that they can be used in aqueous solutions. The others react with water. (See Group III.)

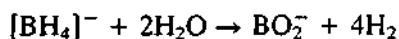

### SOLUBILITY AND HYDRATION

All the simple salts dissolve in water, producing ions, and consequently the solutions conduct electricity. Since  $\text{Li}^+$  ions are small, it might be expected that solutions of lithium salts would conduct electricity better than solutions of the same concentration of sodium, potassium, rubidium or caesium salts. The small ions should migrate more easily towards the cathode, and thus conduct more than the larger ions. However, ionic mobility or conductivity measurements in aqueous solution (Table 9.13) give results in the opposite order  $\text{Cs}^+ > \text{Rb}^+ > \text{K}^+ > \text{Na}^+ > \text{Li}^+$ . The reason for this apparent anomaly is that the ions are hydrated in solution. Since  $\text{Li}^+$  is very small, it is heavily hydrated. This makes the radius of the hydrated ion large, and hence it moves only slowly. In contrast,  $\text{Cs}^+$  is the least hydrated, and the radius of the hydrated  $\text{Cs}^+$  ion is smaller than the radius of hydrated  $\text{Li}^+$ , and hence hydrated  $\text{Cs}^+$  moves faster, and conducts electricity more readily.

Table 9.13 Ionic mobilities and hydration

	Ionic radius (Å)	Ionic mobility at infinite dilution	Approx. radius hydrated ion (Å)	Approx. hydration number	Hydration terms		
					$\Delta H^\circ$	$\Delta S^\circ$ ( $\text{kJ mol}^{-1}$ )	$\Delta G^\circ$
$\text{Li}^+$	0.76	33.5	3.40	25.3	-544	-134	-506
$\text{Na}^+$	1.02	43.5	2.76	16.6	-435	-100	-406
$\text{K}^+$	1.38	64.5	2.32	10.5	-352	-67	-330
$\text{Rb}^+$	1.52	67.5	2.28	10.0	-326	-54	-310
$\text{Cs}^+$	1.67	68.0	2.28	9.9	-293	-50	-276

The hydration number is the average number of water molecules associated with the metal ion. The values need not be whole numbers, and are obtained by measuring the transference of water in a conductivity cell.

Some water molecules touch the metal ion and bond to it, forming a complex. These water molecules constitute the *primary shell* of water. Thus  $\text{Li}^+$  is tetrahedrally surrounded by four water molecules. This may be explained by the oxygen atoms of the four water molecules using a lone pair to form a coordinate bond to the metal ion. With four electron pairs in the valence shell the VSEPR theory predicts a tetrahedral structure. Alternatively, using valence bond theory, the  $2s$  orbital and the three  $2p$  orbitals form four  $sp^3$  hybrid orbitals which are filled by the lone pairs from the oxygen atoms.

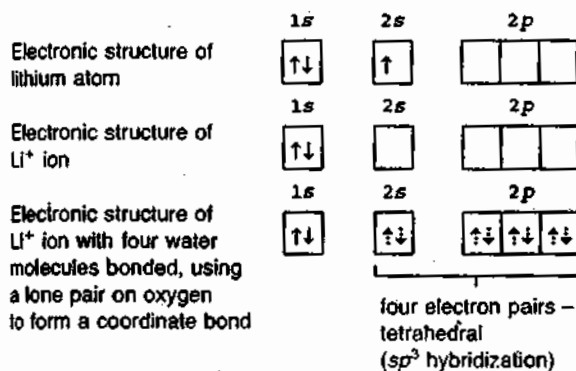

With the heavier ions, particularly Rb<sup>+</sup> and Cs<sup>+</sup>, the number of water molecules increases to six. VSEPR theory predicts an octahedral structure. Valence bond theory also indicates an octahedral arrangement using one *s* orbital, three *p* orbitals and two *d* orbitals for bonding.

A secondary layer of water molecules further hydrates the ions, though these are only held by weak ion-dipole attractive forces. The strength of such forces is inversely proportional to the distance, that is to the size of the metal ion. Thus the secondary hydration decreases from lithium to caesium, and accounts for Li<sup>+</sup> being the most heavily hydrated.

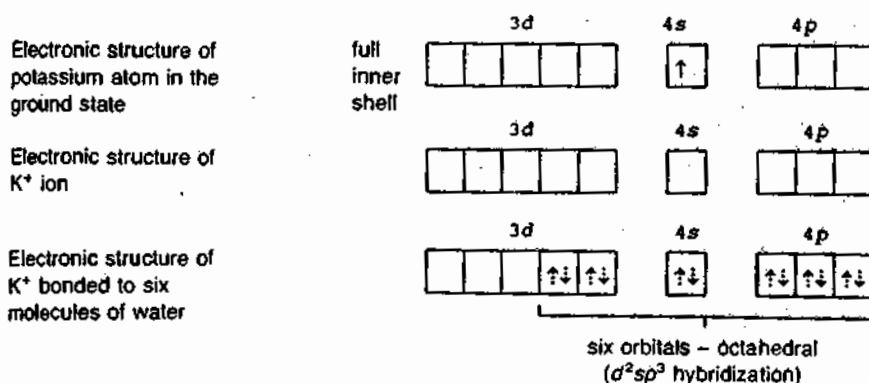

Note that the *d* orbitals comprise a group of three (called *t<sub>2g</sub>* orbitals), and a group of two (called *e<sub>g</sub>* orbitals). Only the group of two is used for bonding.

The size of the hydrated ions is an important factor affecting the passage of these ions through cell walls. It also explains their behaviour on cation-exchange columns, where hydrated Li<sup>+</sup> ions are attached less strongly, and hence eluted first.

The decrease in hydration from Li<sup>+</sup> to Cs<sup>+</sup> is also shown in the crystalline salts, for nearly all lithium salts are hydrated, commonly as trihydrates. In these hydrated Li salts Li<sup>+</sup> is coordinated to 6H<sub>2</sub>O, and the

octahedra share faces, forming chains. Many sodium salts are hydrated, e.g.  $\text{Na}_2\text{CO}_3 \cdot 10\text{H}_2\text{O}$ ,  $\text{Na}_2\text{CO}_3 \cdot 7\text{H}_2\text{O}$  and  $\text{Na}_2\text{CO}_3 \cdot \text{H}_2\text{O}$ . Few potassium salts and no rubidium or caesium salts are hydrated.

The simple salts are all soluble in water, and so in qualitative analysis these metals need to be precipitated as less common salts. Thus  $\text{Na}^+$  is precipitated by adding zinc (or copper) uranyl acetate solution and precipitating  $\text{NaZn}(\text{UO}_2)(\text{Ac})_9 \cdot \text{H}_2\text{O}$  sodium zinc uranyl acetate.  $\text{K}^+$  is precipitated by adding a solution of sodium cobaltinitrite and precipitating potassium cobaltinitrite  $\text{K}_3[\text{Co}(\text{NO}_2)_6]$  or by adding perchloric acid and precipitating potassium perchlorate  $\text{KClO}_4$ . Group I metals can be estimated gravimetrically, sodium as the uranylacetate, and potassium, rubidium and caesium as tetraphenylborates. However, modern instrumental methods such as flame photometry and atomic absorption spectrometry are much quicker and easier to use and are now used in preference to gravimetric analysis.

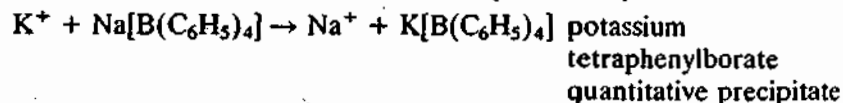
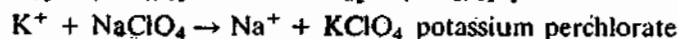

If a salt is insoluble its lattice energy is greater than the hydration energy.  $\text{K}[\text{B}(\text{C}_6\text{H}_5)_4]$  is insoluble because the hydration energy is very small as a result of the large size of its ions.

The solubility of most of the salts of Group I elements in water decreases on descending the group. For a substance to dissolve the energy evolved when the ions are hydrated (hydration energy) must be larger than the energy required to break the crystal lattice (lattice energy). Conversely, if the solid is insoluble, the hydration energy is less than the lattice energy.

Strictly in the two cycles shown in Figure 9.4 we should use Gibbs free energy  $\Delta G$  values. In particular, the lattice energy is an enthalpy  $\Delta H^\circ$  term, and we should use  $\Delta G^\circ$  the standard free energy for converting the crystalline salt into gaseous ions an infinite distance apart. However, the two terms differ only by a small term for the entropy of vaporization

Table 9.14 Hydration and lattice energy values for Group I halides at 25 °C.

	Free energy of hydration $\Delta G^\circ$ (kJ mol <sup>-1</sup> )	Lattice energy (kJ mol <sup>-1</sup> )			
		MF	MCl	MBr	MI
$\text{Li}^+$	-506	-1035	-845	-800	-740
$\text{Na}^+$	-406	-908	-770	-736	-690
$\text{K}^+$	-330	-803	-703	-674	-636
$\text{Rb}^+$	-310	-770	-674	-653	-515
$\text{Cs}^+$	-276	-720	-644	-623	-590

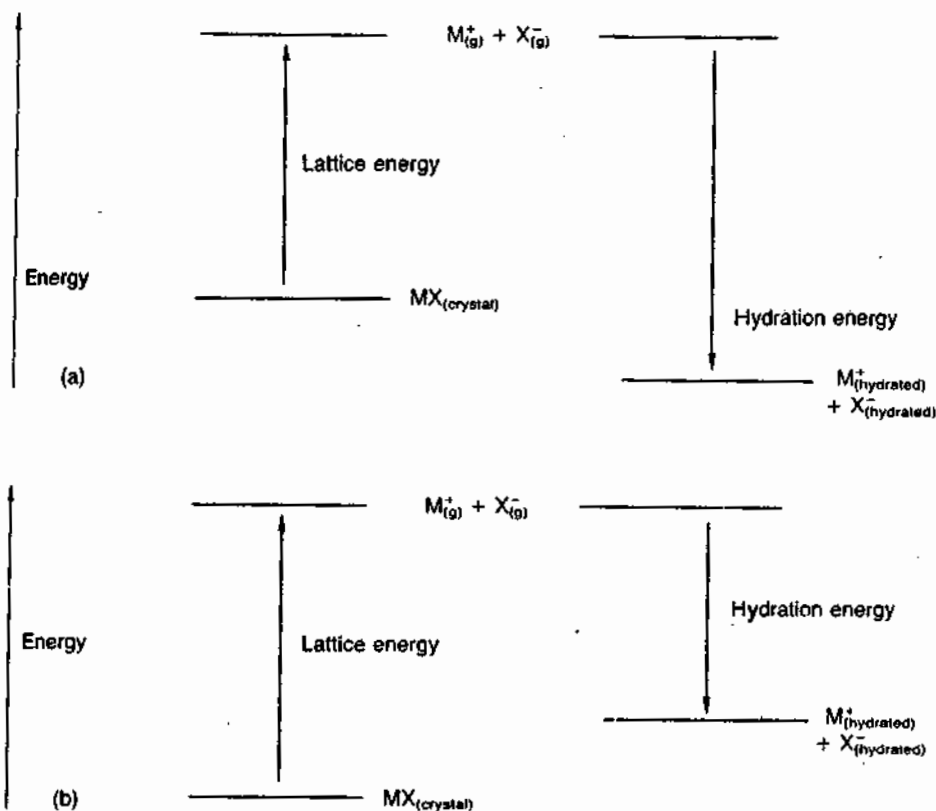

Figure 9.4 Solubility related to lattice energy and hydration energy. (a) The solid dissolves, (b) the solid is insoluble.

of the ions. It should in principle be possible to predict solubilities from lattice energies and hydration energies. In practice there are difficulties in predicting solubilities because the values for the data are not known very accurately, and the result depends on a small difference between two large values.

The reason why the solubility of most Group I metals decreases on descending the group is that the lattice energy only changes slightly, but the free energy of hydration changes rather more. For example, the difference in lattice energy between NaCl and KCl is  $67 \text{ kJ mol}^{-1}$ , and yet the difference in  $\Delta G_{(hydration)}$  for  $\text{Na}^+$  and  $\text{K}^+$  is  $76 \text{ kJ mol}^{-1}$ . Thus KCl is less soluble than NaCl.

The Group I fluorides and carbonates are exceptional in that their solubilities increase rapidly on descending the group. The reason for this is that their lattice energies change more than the hydration energies on descending the group. The lattice energy depends on electrostatic attraction between ions, and is proportional to the distance between the ions, that is proportional to  $1/(r^+ + r^-)$ . It follows that the lattice energy will

Table 9.15 Solubilities of Group I halides

	Solubility (Molar value first, g/100 g H <sub>2</sub> O given in brackets)			
	MF	MCl	MBr	MI
Li	0.1 (0.27)	19.6 (830)	20.4 (177)	8.8 (165)
Na	1.0 (4.22)	6.2 (36)	8.8 (91)	11.9 (179)
K	15.9 (92.3)	4.8 (34.7)	7.6 (67)	8.7 (144)
Rb	12.5 (130.6)	7.5 (91)	6.7 (110)	7.2 (152)
Cs	24.2 (367.0)	11.0 (186)	5.1 (108)	3.0 (79)

vary most when  $r^-$  is small, that is with  $F^-$ , and will vary least when  $r^+$  is large (with  $I^-$ ). The weight of solute dissolving does not provide a very useful comparison of the solubilities, because the molecular weights differ. The easiest way to compare the number of ions is to compare the solubilities as molar quantities.

#### SOLUTIONS OF METALS IN LIQUID AMMONIA

In the presence of impurities or catalysts such as Fe, the alkali metals react with liquid ammonia to form a metal amide and hydrogen.

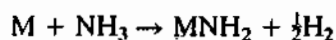

If all catalysts and impurities are absent, then Group I metals, and to a lesser extent the elements Ca, Sr and Ba in Group II and the lanthanide elements Eu and Yb, dissolve directly in very high concentration in liquid ammonia. The metal can be recovered simply by allowing the ammonia to boil off.

Dilute solutions of alkali metals in liquid ammonia are dark blue in colour, and the main species present are solvated metal ions and solvated electrons. If the blue solution is allowed to stand, the colour slowly fades until it disappears owing to the formation of a metal amide. At concen-

Table 9.16 Solubilities in liquid ammonia

Element	Solubility (g metal/100 g NH <sub>3</sub> )	
	-33.4°C	0°C
Li	10.9	11.3
Na	25.1	23.0
K	47.1	48.5

Note that -33.4°C is the boiling point of liquid ammonia at one atmosphere pressure. The 0°C data were measured under pressure.



trations above 3M, solutions are copper-bronze coloured and have a metallic lustre because metal ion clusters are formed.

These solutions of metals in liquid ammonia conduct electricity better than any salt in any liquid, and the conductivity is similar to that of pure metals (specific conductivity of Hg =  $10^4 \text{ ohm}^{-1}$ ; Na/NH<sub>3</sub> =  $0.5 \times 10^4 \text{ ohm}^{-1}$ ; K/NH<sub>3</sub> =  $0.45 \times 10^4 \text{ ohm}^{-1}$ ). Conduction is due mainly to the presence of solvated electrons.

The metals are also soluble in other amines and these solutions are used in organic and inorganic syntheses. These solutions of metals in liquid ammonia act as powerful reducing agents for the elements of Groups IV, V and VI, for many compounds and coordination complexes, and they will even reduce an aromatic ring.

These reductions can be carried out in liquid ammonia, but not in water, because the alkali metals are stronger reducing agents than is hydrogen, and so will react with water and liberate hydrogen. The metals can exist for some time in liquid ammonia.

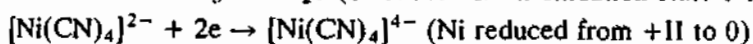
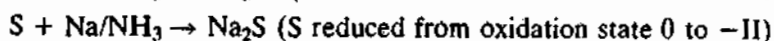
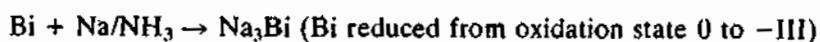

### COMPOUNDS WITH CARBON

If lithium is heated with carbon, an ionic carbide Li<sub>2</sub>C<sub>2</sub> is formed. The other metals do not react with carbon directly, but do form similar carbides when heated with ethyne (formerly called acetylene), or when ethyne is passed through a solution of the metal in liquid ammonia.

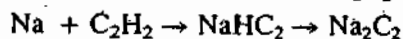

These compounds contain the carbide ion [C≡C]<sup>2-</sup> or hydridocarbide ion [C≡C—H]<sup>-</sup>. The most important reaction of carbides is with water, when they give ethyne (acetylene). Thus they are termed acetylides.



Li<sub>2</sub>C<sub>2</sub>H is used in the industrial manufacture of vitamin A.

The metals potassium, rubidium and caesium react with graphite by invading the space between the layers of carbon in the graphite lattice. They form highly coloured interstitial carbides that are nonstoichiometric, (that is of variable composition), ranging from C<sub>60</sub>K (grey), to C<sub>36</sub>K (blue), to a maximum invasion corresponding to C<sub>8</sub>K (bronze). (See Chapter 12.)

### ORGANIC AND ORGANOMETALLIC COMPOUNDS

The alkali metals replace hydrogen in organic acids, forming salts such as sodium acetate (sodium ethanoate) CH<sub>3</sub>COONa and potassium benzoate

$C_{15}H_{31}COOK$ . Soap is a mixture of the sodium salts of palmitic, oleic and stearic acids. (Palmitic acid  $C_{15}H_{31} \cdot COOH$  occurs in palm oil, oleic acid  $C_{17}H_{33} \cdot COOH$  occurs in olive oil and stearic acid  $C_{17}H_{35} \cdot COOH$  occurs in beef and mutton fat and tallow.) Soap is made by the saponification (hydrolysis) of naturally occurring fats and oils. These fats and oils are esters of glycerol, and their hydrolysis with  $NaOH$  first breaks the ester to glycerol and fatty acids, neutralizing the fatty acid to give the sodium salts, i.e. the soap. World production of soap was 7.8 million tonnes in 1985.

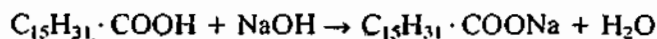
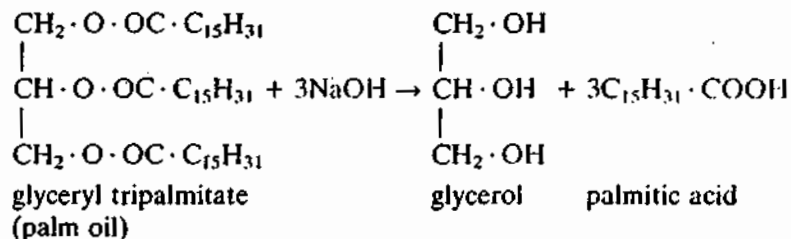

Lithium stearate is also a 'soap', and is made from  $LiOH$  and some natural fat such as tallow. It is widely used to thicken hydrocarbon oils used as lubricants (the so-called detergent oils), and it is also used to make greases for motor vehicles.

Lithium shows a stronger tendency to covalency than the other alkali metals. Lithium also shows a diagonal relationship with magnesium. Magnesium forms a number of alkyl and aryl compounds called Grignard compounds which are very important in making organometallic compounds. It is not surprising that lithium also forms a number of covalent alkyls and aryls which are of great importance in the preparation of organometallic compounds. For example,  $(LiCH_3)_4$  is typical of a range of compounds: it is covalent, soluble in organic solvents, and can be sublimed or distilled. These compounds are frequently tetrameric or hexameric. They are made from the alkyl or aryl halide, usually the chloride, in a solvent such as light petroleum, cyclohexane, toluene or ether.

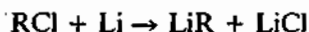

The structure of the  $(LiCH_3)_4$  cluster is unusual. The four  $Li$  atoms occupy the corners of a tetrahedron. Each methyl  $C$  atom is above a face of the tetrahedron, and forms a triple bridge to the three  $Li$  atoms that make up the face of the tetrahedron. The intramolecular  $Li-C$  distance is  $2.31 \text{ \AA}$ . The  $C$  is bonded to the three  $H$  atoms in the methyl group. The  $C$  is also bonded to a  $Li$  atom in another tetrahedron (with an intermolecular  $Li-C$  distance of  $2.36 \text{ \AA}$ ). The coordination number for the  $C$  atom is therefore 7. This cannot be explained by classical bonding theories as the  $C$  atom has only one  $s$  and three  $p$  orbitals available for bonding. The simplest explanation involves a four-centre two-electron bond covering the three  $Li$  atoms at the corners of a face, and the  $C$  atom above it. In a similar way the coordination number of  $Li$  is also 7, made up by three  $Li$

in the tetrahedron, three C at the centres of faces of the tetrahedron, and one Li in another tetrahedron.

Lithium ethyl is tetrameric in the solid  $(\text{LiEt})_4$ , but is hexameric  $(\text{LiEt})_6$  when dissolved in hydrocarbons. The solid is similar in structure to  $(\text{LiCH}_3)_4$ , and the hexamer is thought to comprise an octahedron of Li atoms with Et groups above six of the eight faces, involving multi-centre bonding.

n-Butyl lithium is also tetrameric in the solid  $(\text{LiBu})_4$ . It is commercially available. Production is about 1000 tonnes/year. The main uses are as a polymerization catalyst and for alkylation. It is a very versatile reagent in the laboratory for the synthesis of aromatic derivatives and unsaturated derivatives such as vinyl and allyl lithium. Many of these reactions are similar to those using Grignard reagents.

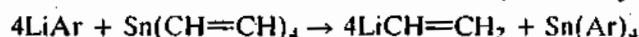

From these an extremely wide range of organometallic and organic compounds can be prepared.

(R = alkyl or aryl)

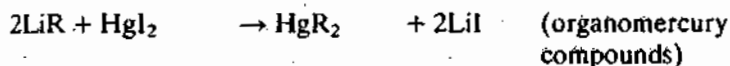
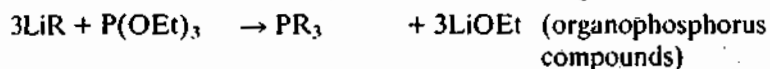
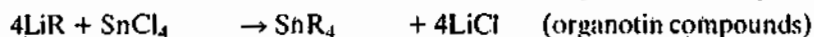
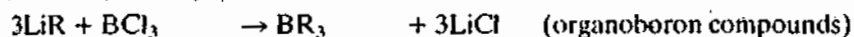

Alkyls of Na, K, Rb and Cs are usually prepared from the corresponding organomercury compound.

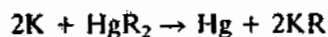

These compounds are ionic  $\text{M}^+\text{R}^-$ , and are extremely reactive. They catch fire in air, react violently with most compounds except nitrogen and saturated hydrocarbons, and are consequently difficult to handle.

## COMPLEXES, CROWNS AND CRYPTS

Group I metals stand out from the other groups in their weak tendency to form complexes. This is predictable because the factors favouring complex

formation are small size, high charge, and empty orbitals of low energy for forming the bonds, and Group I metal ions are very large and have a low charge (+1).

A number of aqua complexes are known such as  $[\text{Li}(\text{H}_2\text{O})_4]^+$  and a primary hydration shell of four  $\text{H}_2\text{O}$  molecules arranged tetrahedrally is found in various crystalline salts.  $\text{Na}^+$  and  $\text{K}^+$  also have the same primary hydration shell, but  $\text{Rb}^+$  and  $\text{Cs}^+$  coordinate six  $\text{H}_2\text{O}$  molecules. Stable complexes are formed with phosphine oxides; for example, complexes of formula  $[\text{LiX} \cdot 4\text{Ph}_3\text{PO}]$ ,  $[\text{LiX} \cdot 5\text{Ph}_3\text{PO}]$  and  $[\text{NaX} \cdot 5\text{Ph}_3\text{PO}]$  are known where X is a large anion such as  $\text{ClO}_4^-$ ,  $\text{I}^-$ ,  $\text{NO}_3^-$  or  $\text{SbF}_6^-$ . There is a slight tendency to form ammine complexes such as  $[\text{Li}(\text{NH}_3)_4]^+$ . Weak complexes of sulphates, peroxosulphates and thiosulphates, and also hexacyanoferrates, are known in solution.

However, some organic chelating agents (particularly salicylaldehyde and  $\beta$ -diketones) are extremely strong complexing agents, and Group I ions form complexes with these. These ligands are very strong complexing agents because they are multidentate, that is they have more than one donor group so they form more than one bond to the metal, and also because they form a ring or chelate compound by bonding to the metal. Examples include salicylaldehyde, acetylacetone, benzoylacetone, methyl salicylate, o-nitrophenol, and o-nitrocresol. The metal usually attains a coordination number of 4 or 6 (see Figure 9.5).

An important development in the chemistry of the alkali metals is the discovery of complexes with polyethers, and 'cryptate complexes' with macrocyclic molecules with nitrogen and oxygen.

The crown ethers are an interesting class of complexing agents first synthesized by Pedersen in 1967. An example is dibenzo-18-crown-6, and the name indicates that there are two benzene rings in the compound, 18 atoms make up a crown-shaped ring, and six of the ring atoms are oxygen. These six oxygen atoms may complex with a metal ion, even with large ions like Group I ions that are not very good at forming complexes. The organic part of the molecule is puckered to give the crown arrangement, and the oxygen atoms with their lone pairs are nearly planar about the metal ion at the centre of the ring. The bonding of the metal ion to the polyether is largely electrostatic, and a close fit between the size of the metal ion and the size of the hole in the centre of the polyether is essential. Cyclic polyethers can have varying sizes of ring; for example, benzo-12-crown-4 has a ring of 12 atoms, four of which are oxygen. The polyethers form complexes selectively with the alkali metal ions. The size of the ring opening in the crown determines the size of the metal ion which may be accommodated. Thus a crown-4 (a cyclic polyether with four oxygens) is selective for  $\text{Li}^+$ ,  $\text{Na}^+$  prefers crown-5, and  $\text{K}^+$  prefers crown-6. It is possible to get complexes with the unusual coordination number of 10, for example  $\text{K}^+(\text{dibenzo-30-crown-10})$ . Crown ethers form a number of crystalline complexes, but more importantly they are sometimes added to organic solvents to make them dissolve inorganic salts which, being ionic, would not normally dissolve. Polyethers of this type act as ion carriers

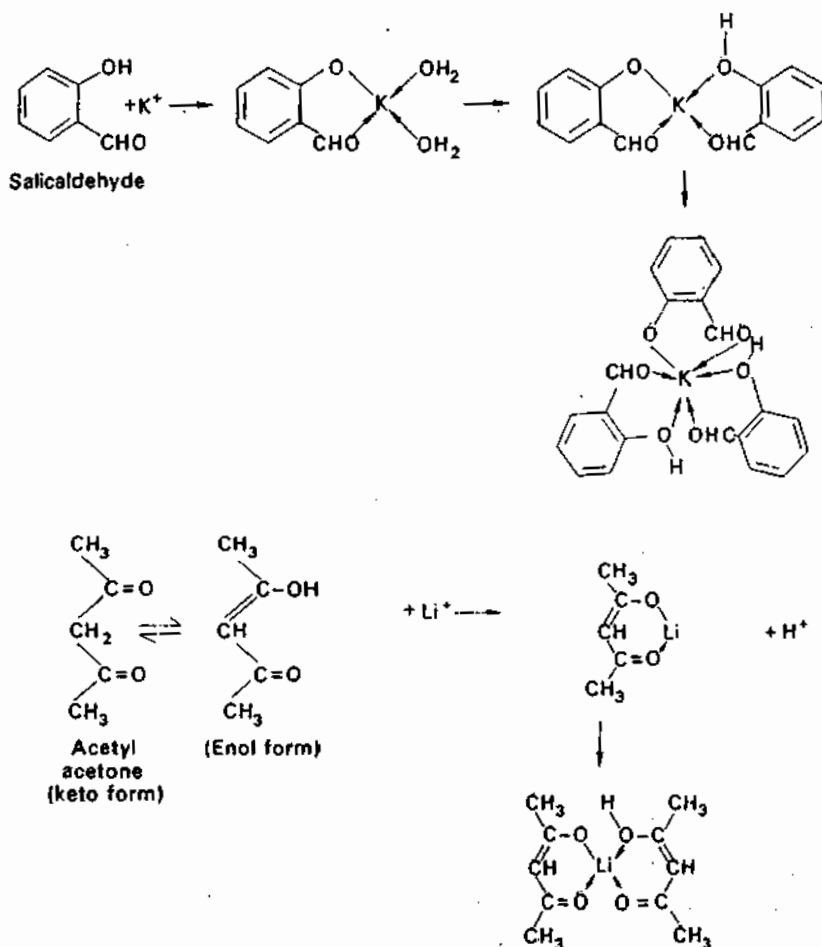

Figure 9.5 Salicylaldehyde and acetylacetone complexes.

inside living cells to transport ions across cell membranes, and thus maintain the balance between  $Na^+$  and  $K^+$  inside and outside cells.

The crown ethers also form some unusual complexes called electriles. These are black and paramagnetic, and have formulae such as  $Cs^+[(\text{crown ether}) \cdot e^-]$ . The structure consists of a  $Cs^+$  ion, and the crown ether with an electron in the central hole instead of a metal ion.

The cryptates are even more selective and even stronger complexing agents than are the crown ethers. They differ from the crown ethers by using nitrogen atoms as well as oxygen atoms to bond to the metal ion, and as they are polycyclic they can surround the metal ion completely. A typical crypt is the molecule  $N[\text{CH}_2\text{CH}_2\text{OCH}_2\text{CH}_2\text{OCH}_2\text{CH}_2]_3\text{N}$ . This is called (2,2,2-crypt) and forms a complex  $[\text{Rb}(\text{crypt})]\text{CNS} \cdot \text{H}_2\text{O}$  in which six oxygen atoms and two nitrogen atoms in the crypt molecule bond to the metal ion, giving the metal ion a coordination number of 8. The

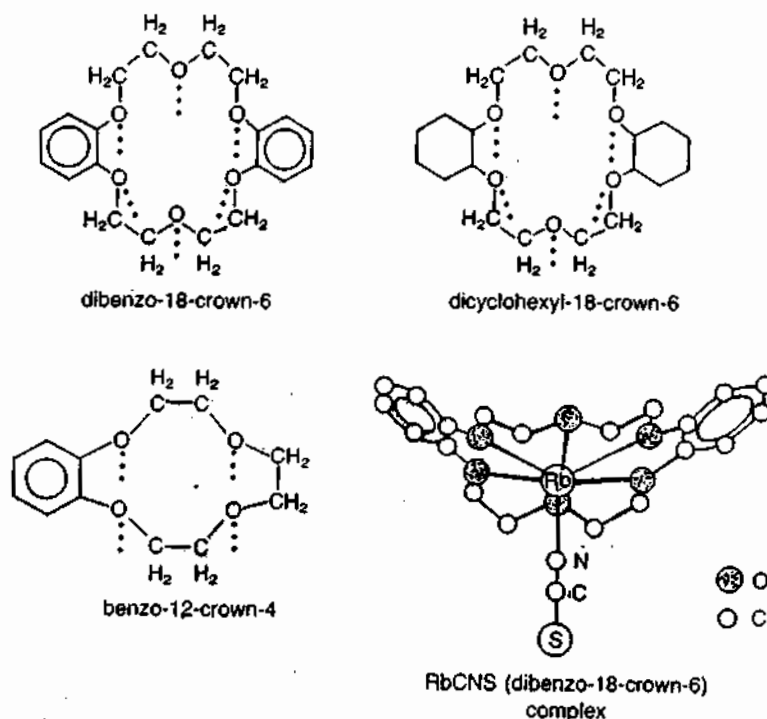

Figure 9.6 Structures of some crown ethers.

ligand completely wraps round the metal ion, hiding it: hence the name crypt. The complex presents a hydrocarbon exterior, and so is soluble in organic solvents. Such complexes are used for solvent extraction, stabilizing uncommon oxidation states, and promoting otherwise improbable reactions.

An unusual compound  $[\text{Na}(2,2,2\text{-crypt})]^+\text{Na}^-$  can be formed by cooling a solution of Na in ethylamine with 2,2,2-crypt. The compound is crystalline and is endothermic. Presumably it is only formed because of the complexing power of the crypt, and the lattice energy of the crystal. It is stable below  $-10^\circ\text{C}$ . The interesting feature is the formation of the  $\text{Na}^-$  sodide ion. The  $\text{K}^-$  potasside ion has been made in a similar way, but is less stable. These alkali compounds are yellow-brown in colour, and are diamagnetic.

#### BIOLOGICAL IMPORTANCE

Living organisms require at least 27 elements, of which 15 are metals. Metals required in major quantities are K, Mg, Na and Ca. Minor quantities of Mn, Fe, Co, Cu, Zn and Mo, and trace amounts of V, Cr, Sn, Ni and Al, are required by at least some organisms.

Bulk quantities of Group I and II metals are required, mainly to balance

the electrical charges associated with negatively charged organic macromolecules in the cell, and also to maintain the osmotic pressure inside the cell, to keep it turgid and prevent its collapse.

In view of the close similarity of chemical properties between Na and K, it is surprising that their biological functions are very different.  $\text{Na}^+$  are actively expelled from cells, whereas  $\text{K}^+$  are not. This ion transport is sometimes called a sodium pump, and it involves both the active expulsion of  $\text{Na}^+$  and the active take-up of  $\text{K}^+$ . Analysis of the fluids inside and outside animal cells shows that ion transport really does occur. In animal cells the concentration of  $\text{K}^+$  is about 0.15 M and the concentration of  $\text{Na}^+$  is about 0.01 M. In body fluids (lymph and blood) the concentrations of  $\text{K}^+$  and  $\text{Na}^+$  are about 0.003 M and 0.15 M respectively. The transport of ions requires energy, and this is obtained by the hydrolysis of ATP. It is estimated that hydrolysis of one ATP molecule to ADP provides enough energy to move three  $\text{Na}^+$  ions out of the cell, and two  $\text{K}^+$  and one  $\text{H}^+$  ions back in to the cell. The mechanism for ion transport involves polyethers natural to the organism.

The different ratio of  $\text{Na}^+$  to  $\text{K}^+$  inside and outside cells produces an electrical potential across the cell membrane, which is essential for the functioning of nerve and muscle cells. The movement of glucose into cells is associated with  $\text{Na}^+$  ions; they enter the cell together. This is favoured by a high concentration gradient. The  $\text{Na}^+$  ions entering the cell in this way must then be expelled. The movement of amino acids is similar.  $\text{K}^+$  ions inside the cell are essential for the metabolism of glucose, the synthesis of proteins, and the activation of some enzymes.

The 1987 Nobel Prize for Chemistry was awarded to C.J. Pedersen, J.M. Lehn and D. Cram for their work on the discovery and applications of crown ethers and cryptates.

## DIFFERENCES BETWEEN LITHIUM AND THE OTHER GROUP I ELEMENTS

The properties of lithium and its compounds differ far more from those of the other Group I elements than the other Group I elements and compounds differ among themselves. Apart from having the same oxidation number as the rest of Group I, lithium compounds may show closer similarities with Group II elements (particularly magnesium) than they show towards their own group. Some of the differences are set out below:

1. The melting and boiling points of lithium metal are much higher than those for the other Group I elements.
2. Lithium is much harder than the other Group I metals.
3. Lithium reacts the least readily with oxygen, forming the normal oxide. It forms a peroxide only with great difficulty, and the higher oxides are unstable.
4. Lithium hydroxide is less basic than the other hydroxides in the group, and therefore many of its salts are less stable.  $\text{Li}_2\text{CO}_3$ ,  $\text{LiNO}_3$  and

LiOH all form the oxide on gentle heating, though the analogous compounds of the rest of the group are stable. Another example of the less basic nature is that though lithium forms a bicarbonate in solution, it does not form a solid bicarbonate, whereas the others all form stable solid bicarbonates.

5. Lithium forms a nitride  $\text{Li}_3\text{N}$ . None of the other Group I elements forms a nitride, but Group II elements form nitrides.
6. Lithium reacts directly with carbon to form an ionic carbide. None of the other Group I elements do this, but Group II elements all react similarly with carbon.
7. Lithium has a greater tendency to form complexes than have the heavier elements, and ammoniated salts such as  $[\text{Li}(\text{NH}_3)_4]^+$  exist as solids.
8.  $\text{Li}_2\text{CO}_3$ ,  $\text{Li}_3\text{PO}_4$  and  $\text{LiF}$  are all insoluble in water, and  $\text{LiOH}$  is only sparingly soluble. The rest of Group I form soluble compounds, but the corresponding magnesium salts are insoluble or sparingly soluble.
9. The halides and alkyls of lithium are far more covalent than the corresponding sodium compounds, and because of this covalency they are soluble in organic solvents. Similarly lithium perchlorate and to a lesser extent sodium perchlorate resemble magnesium perchlorate in their high solubility in acetone (propanone).
10. The lithium ion itself, and also its compounds, are more heavily hydrated than those of the rest of the group.

Several generalizations may be drawn from this apparently anomalous behaviour of lithium.

The first element in each of the main groups (Li, Be, B, C, N, O and F) differs from the rest of the group. This is partly because the first element is much smaller than the subsequent elements, and consequently it is more likely to form covalent compounds (Fajans' rules) and complexes.

The first element in a group can form a maximum of four conventional electron pair bonds. This is because the outer shell of electrons contains only one *s* orbital and three *p* orbitals. The subsequent elements can use *d* orbitals for bonding: they can attain a coordination number of 6, by using one *s*, three *p* and two *d* orbitals. For this reason the coordination number attained by a complex or a covalent compound of the first element in a group is commonly 4, and for the subsequent elements the coordination number is commonly 6. This simple concept is based on a bond consisting of two electrons shared between two atoms. Exceptions occur when multi-centre bonds are formed (as in  $\text{Li}_4(\text{CH}_3)_4$ ).

The similarity between lithium (the first member of Group I) and magnesium (the second element in Group II) is called a diagonal relationship. Diagonal relationships also exist between other pairs of elements Be and Al, B and Si as shown:

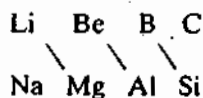



The diagonal relationship arises because of the effects of both size and charge. On descending a group, the atoms and ions increase in size. On moving from left to right in the periodic table, the size decreases. Thus on moving diagonally, the size remains nearly the same. For example, lithium is smaller than sodium, and magnesium is also smaller than sodium, and hence lithium and magnesium are similar in size. The sizes of  $\text{Li}^+ = 0.76 \text{ \AA}$  and  $\text{Mg}^{2+} = 0.72 \text{ \AA}$  are close, and so in situations where size is important their behaviour should be similar.

Beryllium and aluminium also show a diagonal relationship. In this case the sizes are not so close ( $\text{Be}^{2+} = 0.45 \text{ \AA}$  and  $\text{Al}^{3+} = 0.535 \text{ \AA}$ ), but the charge per unit area is similar ( $\text{Be}^{2+}$  2.36 and  $\text{Al}^{3+}$  2.50) because the charges are 2+ and 3+ respectively.

$$\text{Charge per unit area} = \frac{(\text{ionic charge})}{\frac{4}{3} \cdot \pi \cdot (\text{ionic radius})^2}$$

It is sometimes suggested that the diagonal relationship arises because of a diagonal similarity in electronegativity values.

Li	Be	B	C
1.0	1.5	2.0	2.5
	\	\	\
Na	Mg	Al	Si
0.9	1.2	1.5	1.8

Since ionic size and electronegativity are closely related, this is part of the same picture.

#### FURTHER READING

- Addison, C.C. (1984) *The Chemistry of the Liquid Alkali Metals*, John Wiley, Chichester.
- Bach, R.O. (ed.) (1985) *Lithium: Current Applications in Science, Medicine and Technology*, John Wiley, Chichester and New York, (Conference proceedings.)
- Dietrich, B. (1985) Coordination chemistry of alkali and alkaline earth cations with macrocyclic ligands, *J. Chem. Ed.*, 62, 954-964. (Crowns and crypts.)
- Gockel, G.W. (1990) *Crown Ethers and Cryptands* (one of a series on Supramolecular Chemistry, ed. Stoddart, J.F.), Royal Society for Chemistry, London.
- Hanusa, T.P. (1987) Re-examining the diagonal relationships, *J. Chem. Ed.*, 64, 686-687.
- Hart, W.A. and Beumel, O.F. (1973) *Comprehensive Inorganic Chemistry*, Vol. 1 (Chapter 7: Lithium and its compounds), Pergamon Press, Oxford.
- Hughes, M.N. and Birch, N.J. (1982) IA and IIA cations in biology, *Chemistry in Britain*, 18, 196-198.
- Jolly, W.L. (1972) *Metal Ammonia Solutions*, Dowden, Hutchinson and Row, Stroudsburg, PA.
- Lagowski, J. (ed.) (1967) *The Chemistry of Non-aqueous Solvents* (Chapter 6), Academic Press, New York. (Solutions of metals in liquid ammonia.)
- Lehn, J.M. (1973) Design of organic complexing agents. *Structure and Bonding*, 16, 1-69.
- Lippard, S. (ed.) (1984) *Progress in Inorganic Chemistry*, Vol. 32 by Dye, J.L.

- Electrides, Negatively Charged Metal Ions, and Related Phenomena*, Wiley-Interscience, New York.
- March, N.N. (1990) *Liquid Metals*, Cambridge University Press.
- Parker, D. (1983) Alkali and alkaline earth cryptates. *Adv. Inorg. and Radiochem.*, 27, 1-26.
- Pedersen, C.J. (1967) *J. Am. Chem. Soc.*, 89, 2495, 7017-7036. (Cyclic polyethers and their complexes with metals.)
- Pedersen, C.J. and Frensdorf, H.K. (1972) *Angew. Chem.*, 11, 16-25. (Cyclic polyethers and their complexes with metals.)
- Sargeson, A.M. (1979) Caged metal ions. *Chemistry in Britain*, 15, 23-27. (A straightforward account of crown ethers, crypts etc.)
- The Chemical Society (1967) *The Alkali Metals*, (Special Publication No. 22), London.
- Waddington, T.C. (ed.) (1969) *Non Aqueous Solvent Systems* (Chapter 1 by Jolly, W.L. and Hallada, C.J.), Nelson. (Solutions of metals in liquid ammonia.)
- Wakefield, B.J. (1976) *The Chemistry of Organolithium Compounds*, Pergamon Press, Oxford.
- Whaley, T.P. (1973) *Comprehensive Inorganic Chemistry*, Vol. 1 (Chapter 8: Sodium, potassium, rubidium, caesium and francium), Pergamon Press, Oxford.

### PROBLEMS

1. Why are Group I elements:
  - (a) univalent
  - (b) largely ionic
  - (c) strong reducing agents
  - (d) poor complexing agents?
  - (e) Why do they have the lowest first ionization energy values in their periods?
2. Why are the Group I metals soft, low melting and of low density? (Refer back to Chapter 5.)
3. Lithium is the smallest ion in Group I. It would therefore be expected to have the highest ionic mobility, and hence solutions of its salts would be expected to have a higher conductivity than solutions of caesium salts. Explain why this is not so.
4. What is the reason for lithium having a greater tendency to form covalent compounds than the other elements in the group?
5. The atomic radius for lithium is 1.23 Å. When the outermost 2s electron is ionized off, the ionic radius of Li<sup>+</sup> is 0.76 Å. Assuming that the difference in radii relates to the space occupied by the 2s electron, calculate what percentage of the volume of the lithium atom is occupied by the single valence electron. Is this assumption fair? (Volume of a sphere is  $\frac{4}{3} \cdot \pi r^3$ .) (Answer 76.4%.)
6. Why and in what ways does lithium resemble magnesium?
7. What products are formed when each of the Group I metals is burnt in oxygen? How do these products react with water? Use the molecular

- orbital theory to describe the structure of the oxides formed by sodium and potassium.
8. Explain the difference in reactivity of the Group I metals with water.
  9. The ionization energies of Group I elements suggest that caesium should be the most reactive, but the standard electrode potentials suggest that lithium is the most reactive. Reconcile these two observations.
  10. Describe how you would make lithium hydride. Give equations to show two important properties of lithium hydride. The compound contains the isoelectronic ions  $\text{Li}^+$  and  $\text{H}^-$ . Which ion is the larger and why?
  11. Give equations to show the reactions between sodium and: (a)  $\text{H}_2\text{O}$ , (b)  $\text{H}_2$ , (c) graphite, (d)  $\text{N}_2$ , (e)  $\text{O}_2$ , (f)  $\text{Cl}_2$ , (g)  $\text{Pb}$ , (h)  $\text{NH}_3$ .
  12. Group I elements generally form very soluble compounds. Name some insoluble or sparingly soluble compounds. How are these elements detected and confirmed in qualitative analysis?
  13. Describe the colour and nature of the solutions of Group I metals in liquid ammonia. Give an equation to show how these solutions decompose.
  14. Draw the crystal structures of  $\text{NaCl}$  and  $\text{CsCl}$ . What is the coordination number of the metal ion in each case? Explain why these two salts adopt different structures.
  15. Do the alkali metals form many complexes? Which of the metal ions in the group are best at forming complexes? Which are the best complexing agents?
  16. Draw the complexes formed by  $\text{Li}^+$ ,  $\text{Na}^+$  and  $\text{K}^+$  with acetyl acetone and with salicylaldehyde. Why do the coordination numbers differ?
  17. What is a crown ether, and what is a crypt? Draw examples of Group I complexes with these molecules. In what way is this type of complex of biological importance?
  18. Which of the following methods would you use to extinguish a fire of lithium, sodium or potassium metals? Explain why some of these are unsuitable, and give the reactions involved.
    - (a) water
    - (b) nitrogen
    - (c) carbon dioxide
    - (d) asbestos blanket
  19. The four general methods of extracting metals are thermal decomposition, displacement of one element by another, chemical reduction, and electrolytic reduction. How are Group I metals obtained and why are the other methods unsuitable?

20. 0.347 g of a metal (A) was dissolved in dilute  $\text{HNO}_3$ . This solution gave a red coloration to a non-luminous Bunsen burner flame, and on evaporation gave 0.747 g of metal oxide (B). (A) also reacted with nitrogen, forming a compound (C), and with hydrogen, forming (D). On reacting 0.1590 g of (D) with water, a gas (E) was evolved and a sparingly soluble compound (F) formed, which gave a strongly basic reaction and required 200 ml of 0.1000 M hydrochloric acid to neutralize it. Identify the substances (A) to (F) and explain the reactions involved.

The chlor-alkali industry includes the production of three main chemicals: sodium hydroxide (sometimes called caustic soda), chlorine, and sodium carbonate (sometimes called soda ash). All three chemicals are made from sodium chloride.

NaOH and Cl<sub>2</sub> are produced simultaneously by the electrolysis of an aqueous solution of NaCl. NaOH is the most important alkali used in industry, and Cl<sub>2</sub> is also an extremely important industrial chemical. Sodium carbonate is included with the other two chemicals for two reasons – first because in many applications such as making paper, soap and detergents it can be used interchangeably with sodium hydroxide, and second because Na<sub>2</sub>CO<sub>3</sub> can quite easily be converted into NaOH (or vice versa) using the Lime – caustic soda process. In this process, the reaction is reversible, and depending on the relative demands and cost of sodium carbonate and sodium hydroxide it may be used in either direction. Before 1955 Na<sub>2</sub>CO<sub>3</sub> was used very extensively for water softening as it prevented the formation of scum when using soap in hard water. Soap is discussed under 'Organic and organometallic compounds' in Chapter 9, and hard water is discussed in Chapter 11. Thus before 1955 it was economic to make Na<sub>2</sub>CO<sub>3</sub> from NaOH. More recently the use of soap has declined as detergents have become more widely used, and with this the demand for Na<sub>2</sub>CO<sub>3</sub> has declined. Nowadays the reverse reaction is carried out on a limited scale, converting Na<sub>2</sub>CO<sub>3</sub> to NaOH.

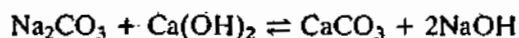

All three chemicals are classed as 'heavy inorganic chemicals' because of the very large tonnages involved. A list of the chemicals produced in the largest quantities is shown in Table 10.1.

## LEBLANC PROCESS

C.W. Scheele discovered chlorine in 1774 by oxidizing hydrochloric acid with manganese dioxide.



Table 10.1 Tonnes of 'heavy chemicals' produced in 1985

Chemical	Millions of tonnes		
	World	USA	UK
1. H <sub>2</sub> SO <sub>4</sub>	133.5	36.0	2.5
2. CaO	106.6	14.5	0.85
3. O <sub>2</sub>	(100)	16.7	2.5
4. NH <sub>3</sub>	80.8	14.3	-
5. NH <sub>4</sub> NO <sub>3</sub>	(75)	-	-
6. N <sub>2</sub>	(60)	-	-
7. ethylene	38.9	13.9	1.4
8. NaOH	34.0	9.8	-
9. HNO <sub>3</sub>	30.2	6.9	3.1
10. Na <sub>2</sub> CO <sub>3</sub>	26.1	7.7	-
11. H <sub>3</sub> PO <sub>4</sub>	24.3	13.1	0.52
12. Cl <sub>2</sub>	23.3	9.4	1.0
13. propylene	20.2	6.8	0.97
14. ethanol	15.8	0.9	0.24
15. benzene	15.6	4.1	0.84
16. vinyl chloride	11.4	3.1	0.31
17. methanol	10.0	2.7	-
18. HCl	9.0	2.5	0.16

He also described the bleaching properties of chlorine, and these eventually led to demand for both chlorine and sodium hydroxide on an industrial scale for use in the textiles industry. At that time there was no chemical industry, so people had to make their own chemicals. The first problem was to make the HCl. This was produced by the Leblanc process. Though the process is now obsolete, it warrants description because it was the first large scale industrial process in Europe; it lasted for most of the nineteenth century, and it illustrates the need to consider what raw materials are needed, how they can be obtained, and the commercial need to sell everything produced. (At this time Europe led the world industrially, and the process was imported into the USA from Europe.)

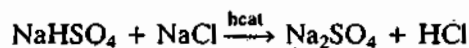
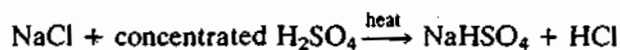

The HCl was then oxidized to give Cl<sub>2</sub>.

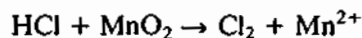

The Na<sub>2</sub>SO<sub>4</sub> was used either to make glass, or to make Na<sub>2</sub>CO<sub>3</sub> and NaOH.

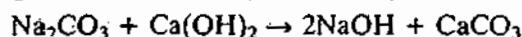
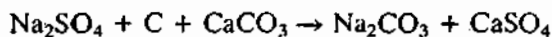

In this process, the chemicals used are  $\text{H}_2\text{SO}_4$ ,  $\text{NaCl}$ ,  $\text{CaCO}_3$  and  $\text{C}$ , and the products are  $\text{NaOH}$  and  $\text{Cl}_2$  (and to a lesser extent  $\text{Na}_2\text{SO}_4$ ). The raw materials were obtained:

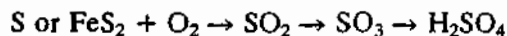

$\text{NaCl}$  – mined or extracted as brine solution

$\text{CaCO}_3$  – mined as limestone

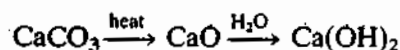

In 1874 world production of  $\text{NaOH}$  was 525 000 tonnes, of which 94% was produced by the Leblanc process. Production of  $\text{NaOH}$  had risen to 1 800 000 tonnes by 1902, but by then only 8% was produced by the Leblanc process. The Leblanc process became obsolete because cheaper methods were found. It was replaced in turn by the Weldon process, the Deacon process, and eventually by electrolysis.

#### WELDON AND DEACON PROCESSES

The Leblanc process used  $\text{MnO}_2$  to oxidize the  $\text{HCl}$ , but the  $\text{MnCl}_2$  formed was wasted. The Weldon process (1866) recycled the  $\text{MnCl}_2$ , and was therefore cheaper.

In the Deacon process (1868), air was used to oxidize the  $\text{HCl}$  instead of using  $\text{MnO}_2$ . A gas phase reaction was performed between  $\text{HCl}$  and air on the surface of bricks soaked in a solution of  $\text{CuCl}_2$ , which acted as a catalyst. The reaction is reversible, and a conversion of about 65% is possible.

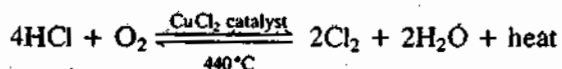

Nowadays about 90% of the world supply of chlorine comes from the electrolysis of an aqueous solution of sodium chloride (brine). Most of the remainder is produced by the electrolysis of molten  $\text{NaCl}$  in the production of sodium metal, electrolysis of aqueous  $\text{KCl}$  in the production of  $\text{KOH}$ , and electrolysis of molten  $\text{MgCl}_2$  in the extraction of magnesium metal. However, a small amount is made by the oxidation of  $\text{HCl}$  with air, in a slightly modified Deacon process. This started in 1960, and uses a didymium promoted catalyst of  $\text{Dm}_2\text{O}_3$  and  $\text{CuCl}_2$  at a slightly lower temperature of  $400^\circ\text{C}$ . (Didymium is an old name and means 'twin'. It was once thought to be an element, but was later resolved into two lanthanide elements, praseodymium and neodymium. The catalyst is a finely powdered mixture of solids which flows like a liquid, and this is termed a fluidized bed.)

#### ELECTROLYTIC PROCESSES

Electrolysis of brine was first described in 1800 by Cruickshank, but it was not until 1834 that Faraday put forward the Laws of Electrolysis. At that

time electrolysis was strictly limited because primary batteries were the only source of electricity. This changed in 1872 when Gramme invented the dynamo. The first commercial electrolytic plant was started in Frankfurt (Germany) in 1891, where the cell was filled, electrolysed, emptied, then refilled... and so on. This was therefore a *discontinuous or batch process*. Clearly a cell which could run continuously, and did not need emptying, would produce more and cost less to operate. Many developments and patents attempting to exploit the commercial possibilities appeared over the next twenty years. The first commercially operated plant to use a *continuous diaphragm cell* was probably that designed by Le Seur at Romford (Maine) in 1893, followed by Castner cells at Saltville (Virginia, USA) in 1896. The first in the UK was set up by Hargreaves and Bird in 1897 at Runcorn. In all of these (and also in many modern diaphragm cells), asbestos was used as the diaphragm to separate the anode and cathode compartments. Brine was constantly added, and NaOH and Cl<sub>2</sub> were produced continuously.

About the same time, Castner (who was an American working in Birmingham, England) and Kellner (an Austrian working in Vienna) developed and patented similar versions of the *mercury cathode cell* in 1897. Their combined patents were used by the Castner Kellner Alkali Company, also at Runcorn, and also in 1897.

The same two types of cell, diaphragm and mercury cathode, still remain in use. The early electrolytic plants produced about 2 tonnes of chlorine per day, but modern plants produce 1000 tonnes per day.

In the electrolysis of brine, reactions occur at both the anode and the cathode.

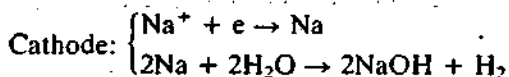
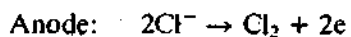

Side reactions may also occur if the products mix:

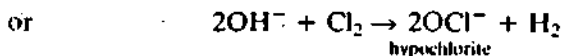

and also another reaction may occur to a small extent at the anode:

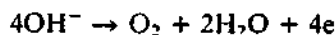

### DIAPHRAGM CELL

A porous diaphragm of asbestos is used to keep the H<sub>2</sub> and Cl<sub>2</sub> gases (produced at the electrodes) separated from one another. If H<sub>2</sub> and Cl<sub>2</sub> gases mix they react, and the reaction may be explosive. In daylight (and more so in sunlight) a photolytic reaction takes place which produces chlorine atoms. These lead to an explosive chain reaction with hydrogen.



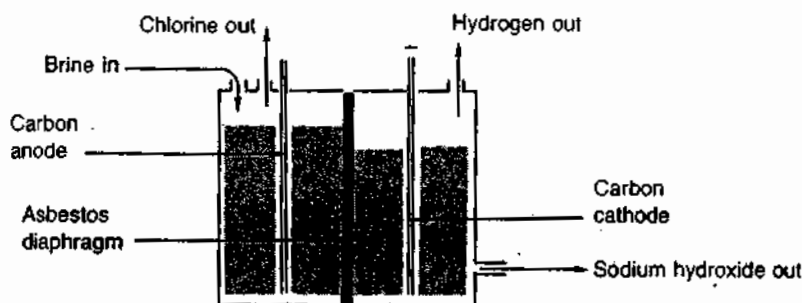

Figure 10.1 A diaphragm cell.

The diaphragm also separates the anode and cathode compartments. This reduces the chance that NaOH produced in the cathode compartment can mix and react with Cl<sub>2</sub> produced in the anode compartment. This reduces the chance of the side reaction producing sodium hypochlorite, NaOCl. However, some sodium hydroxide or OH<sup>-</sup> may diffuse into the other compartment, and this is inhibited by maintaining the level of electrolyte higher in the anode compartment than in the cathode compartment, so there is a small positive flow from the anode to the cathode compartment. Traces of oxygen are produced in a side reaction. This reacts with the carbon electrodes, gradually destroying them and forming CO<sub>2</sub>.

There is considerable interest in using thin synthetic plastic membranes for the diaphragm instead of asbestos. These membranes are made of a polymer called nafion, supported on a teflon mesh. (Nafion is a copolymer of tetrafluoroethylene and a perfluorosulphonylethoxy ether.) Plastic membranes have a lower resistance than asbestos.

Less than half the NaCl is converted to NaOH, and a mixture of about 11% NaOH and 16% NaCl is usually obtained. This solution is concentrated in a steam evaporator, when a considerable amount of NaCl crystallizes out, giving a final solution containing 50% NaOH and 1% NaCl. *It is important to note that NaOH made in this way always contains some NaCl.* This may or may not matter, depending on how the NaOH is to be used. For most industrial purposes, the product is sold as a solution, as the cost of evaporating it to give the solid exceeds the increased cost of transporting the solution.

## MERCURY CATHODE CELL

During the electrolysis of brine, Na<sup>+</sup> ions migrate towards the cathode, and when they get there the ions are discharged.

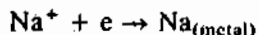

If the cathode is made of mercury, the Na atoms produced dissolve in the mercury and form an amalgam, or loose alloy. The amalgam is pumped to a different compartment called the denuder, where water trickles over

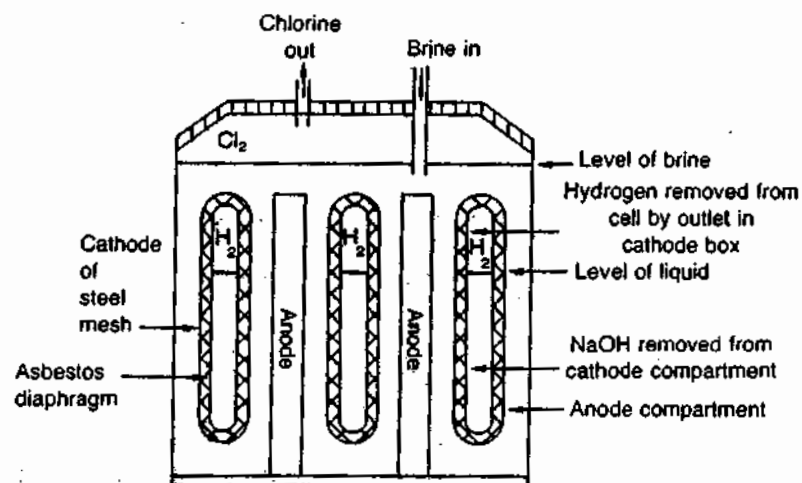
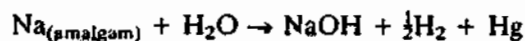

Figure 10.2 Commercial diaphragm cell for Cl<sub>2</sub> and NaOH.

lumps of graphite (here acting as an inert solid). The water and the Na in the amalgam react, and in this way *pure* NaOH at 50% strength is obtained.



The clean mercury is recycled back to the electrolysis tank. Originally the anodes were made of graphite, but because traces of oxygen are produced in a side reaction they become pitted, owing to the formation of CO<sub>2</sub>. The anodes are now made of steel coated with titanium. Titanium is very resist-

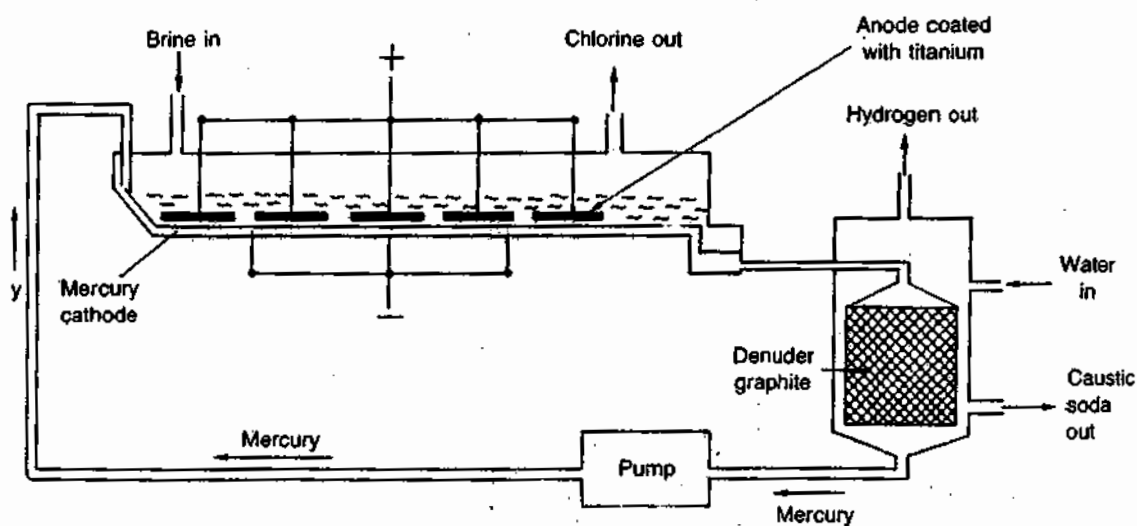

Figure 10.3 Mercury cathode cell for Cl<sub>2</sub> and NaOH.

ant to corrosion, and this not only overcomes the problem of pitting and forming  $\text{CO}_2$ , but also lowers the electrical resistance.

### QUANTITIES

In both electrolytic processes (diaphragm cell and mercury cathode cell) equimolar amounts of  $\text{Cl}$  and  $\text{NaOH}$  are produced. Since  $\text{Cl}$  has an atomic weight of 35.5, and  $\text{NaOH}$  has a molecular weight of 40, it follows that electrolysis yields 40 parts by weight of  $\text{NaOH}$  to 35.5 parts of  $\text{Cl}_2$ . This corresponds to 1.13 tonnes of  $\text{NaOH}$  for 1 tonne of  $\text{Cl}_2$ . In 1985 world production of  $\text{Cl}_2$  was 23.3 million tonnes, which accounts for 26 million tonnes of  $\text{NaOH}$ . In fact production of  $\text{NaOH}$  was 34 million tonnes, so clearly some was made in other ways.

Prior to 1965 demand for  $\text{NaOH}$  exceeded that for  $\text{Cl}_2$ , so  $\text{Cl}_2$  was cheap. Since then the position has reversed, largely due to the use of large amounts of  $\text{Cl}_2$  in making plastics such as polyvinyl chloride. (World production of PVC was 11.5 million tonnes in 1985.)

### SODIUM CARBONATE

World production of  $\text{Na}_2\text{CO}_3$  in 1985 was 26.1 million tonnes, and 45% of this was used in the glass industry. Smaller amounts were used to make various sodium phosphates and polyphosphates which are used for water

Table 10.2 Chlorine production in 1985 (million tonnes)

World production (excluding USSR)	23.3
USA	9.4 (40%)
West Germany	3.5 (15%)
Canada	1.4 (6%)
France	1.4 (6%)
UK	1.0 (4%)
Japan	0.93 (4%)
Italy	0.92 (4%)
Spain	0.51 (2%)

Table 10.3 Major uses of chlorine

	EEC	USA
Vinyl chloride monomer ( $\text{CH}_2=\text{CHCl}$ )	31%	18%
Organic intermediates	16%	
Chlorinated solvents ( $\text{C}_2\text{H}_3\text{Cl}$ approx. 40 000 tonnes/year, $\text{CH}_2\text{Cl}\cdot\text{CH}_2\text{Cl}$ etc.)	14%	22%
Propylene oxide	8%	5%
Bleaching wood pulp and paper		11%
Chloromethanes ( $\text{CCl}_4$ , $\text{CHCl}_3$ etc.)		10%
Inorganic materials (bleaching powder, sodium hypochlorite)		8%
Other uses	31%	26%

Table 10.4 Major uses of caustic soda

	USA
Inorganic chemicals	21%
Organic chemicals	17%
Wood pulp and paper making	14%
Neutralizations	12%
Alumina production	7%
Soap	4%
Rayon	4%
Other uses	21%

Table 10.5 Major uses of sodium carbonate

	USA
Glass - bottles	34%
Sodium phosphates	12%
Glass - sheets and glass fibre	11%
Sodium silicate	5%
Alkaline cleaners	5%
Wood pulp and paper making	4%
Other uses	29%

softening (being added to various cleaning powders), and in wood pulp and paper making. The increased awareness of the effect of 'acid rain' on plants and buildings has led to a new use for  $\text{Na}_2\text{CO}_3$  in treating the flue gases from coal- and oil-fired power stations, to remove  $\text{SO}_2$  and  $\text{H}_2\text{SO}_4$ . This use may eventually account for a large tonnage of  $\text{Na}_2\text{CO}_3$ .

The main producing countries are the USA (30%), the USSR (19%), China (8%), West Germany (5%), Japan (4%), Bulgaria (4%) and Poland (4%). Most of the  $\text{Na}_2\text{CO}_3$  is produced synthetically by the Solvay (ammonia-soda) process. However, since prehistoric times a natural deposit called Trona,  $\text{Na}_2\text{CO}_3 \cdot \text{NaHCO}_3 \cdot 2\text{H}_2\text{O}$ , has been obtained from dried-up lake beds in Egypt. Large amounts are now mined, particularly in the USA and Kenya. In the USA 7.7 million tonnes of  $\text{Na}_2\text{CO}_3$  were used in 1985. About 5 million tonnes/year of  $\text{Na}_2\text{CO}_3$  is made from Trona. Trona is sometimes called sodium sesquicarbonate (sesqui means one and a half), and this is converted to sodium carbonate by heating.

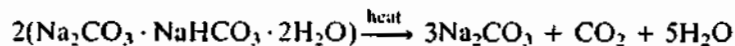

In the description of the chlor-alkali industry it was mentioned that sodium carbonate (soda ash) can be used instead of  $\text{NaOH}$  in applications such as making paper, soap and detergents, and that sodium carbonate can be used to make  $\text{NaOH}$  by the lime - caustic soda process. However, as  $\text{NaOH}$  is at present cheap and plentiful, not much sodium carbonate is

used for these purposes. With the increased use of detergents, there has been a decline in the use of 'washing soda'  $\text{Na}_2\text{CO}_3 \cdot 10\text{H}_2\text{O}$  for water softening.

### THE SOLVAY (OR AMMONIA-SODA) PROCESS

There have been many attempts to make  $\text{Na}_2\text{CO}_3$  more cheaply than by the Leblanc process, by using the overall reaction:



The reaction was first studied by Freshnel in 1811, and several commercial plants were built but were quickly abandoned because they failed to make a profit, or they encountered technical problems such as corrosion of the plant, contamination of the product and blocked pipes. Ernest Solvay was the first to operate a commercial plant successfully, in Belgium (1869).

The process is much more complicated than the overall equation implies, and to make things worse the reaction is reversible and only 75% of the  $\text{NaCl}$  is converted. The first stage in the process is to purify saturated brine, and then react it with gaseous ammonia. The ammoniated brine is then carbonated with  $\text{CO}_2$ , forming  $\text{NaHCO}_3$ . This is insoluble in the brine solution because of the common ion effect and so can be filtered off, and on heating to  $150^\circ\text{C}$  it decomposes to anhydrous  $\text{Na}_2\text{CO}_3$  (called light soda ash in industry because it is a fluffy solid with a low packing density of about  $0.5 \text{ g cm}^{-3}$ ). Next  $\text{CO}_2$  is stripped (removed) by heating the solution, and the  $\text{CO}_2$  is reused. Then the  $\text{NH}_3$  is driven off by adding alkali (a slurry of lime in water), and the ammonia is reused. Lime ( $\text{CaO}$ ) is obtained by heating limestone ( $\text{CaCO}_3$ ), and this also provides the  $\text{CO}_2$  required. When lime is mixed with water it gives  $\text{Ca}(\text{OH})_2$ .

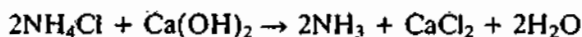
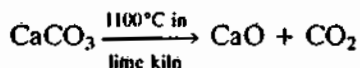
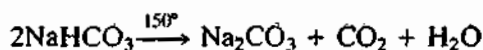
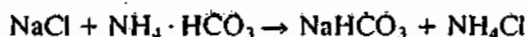

Thus the materials consumed are  $\text{NaCl}$  and  $\text{CaCO}_3$ , and there is one useful product,  $\text{Na}_2\text{CO}_3$ , and one by-product,  $\text{CaCl}_2$ . There is little requirement for  $\text{CaCl}_2$ , so only a little is recovered from solution, and the rest is wasted. The largest use of  $\text{Na}_2\text{CO}_3$  is for glass making (Table 10.5), and this requires 'heavy ash', which is  $\text{Na}_2\text{CO}_3 \cdot \text{H}_2\text{O}$ . To obtain this, the 'light ash' produced in the Solvay process (which is anhydrous  $\text{Na}_2\text{CO}_3$ ) is recrystallized from hot water.

## FURTHER READING

- Adam, D.J. (1980) Early industrial electrolysis, *Education in Chemistry*, **17**, 13-14, 16.
- Borgstedt, H.U. and Mathews, C.K. (1987) *Applied Chemistry of the Alkali Metals*, Plenum, London.
- Boynton, R.S. (1980) *Chemistry and Technology of Lime and Limestone*, 2nd ed., John Wiley, Chichester.
- Buchner, W., Schleibs, R., Winter, G. and Buchel, K. H. (1989) *Industrial Inorganic Chemistry*, V.C.H. Publishers, Weinheim.
- Grayson, M. and Eckroth, D. (eds), *Kirk-Othmer Concise Encyclopedia of Chemical Technology*, John Wiley.
- Kirk-Othmer Encyclopedia of Chemical Technology* (1984) (26 volumes), 3rd ed., Wiley-Interscience.
- Stephenson, R.M. (1966) *Introduction to the Chemical Process Industries*, Van Nostrand Reinhold, New York.
- Thompson, R. (ed.) (1986) *The Modern Inorganic Chemicals Industry* (chapter by Purcell, R.W., The Chlor-Alkali Industry; chapter by Campbell, A., Chlorine and Chlorination, Special Publication No. 31, The Chemical Society, London.
- Venkatesh, S. and Tilak, S. (1983) Chlor-alkali technology, *J. Chem. Ed.*, **60**, 276-278.

Production figures for the top 50 chemicals produced in the USA each year are published in *Chemical and Engineering News* in one of the issues in June each year (see Appendix K).

## PROBLEMS

1. What chemicals are obtained industrially from sodium chloride? Outline the processes.
2. Describe in detail the industrial electrolysis of sodium chloride. Comment on the purity of the products.
3. What are the main uses of chlorine, sodium and caustic soda? Why has demand for chlorine increased dramatically?
4. What is  $\text{Na}_2\text{CO}_3$  used for? Why has its use declined? Explain how at different times NaOH has been converted into  $\text{Na}_2\text{CO}_3$ , and at other times  $\text{Na}_2\text{CO}_3$  has been converted into NaOH.